



LS2 2018-21

Day by Day Schedule

Many thanks for your input

Working days 2018-19

December 2018
11 days included

Mon	Tue	Wed	Thu	Fri	Sat	Sun
					1	2
3	4	5	6	7	8	9
10	11	12	13	14	15	16
17	18	19	20	21	22	23
24	25	26	27	28	29	30
31						

January 2019
22 days included

Mon	Tue	Wed	Thu	Fri	Sat	Sun
	1	2	3	4	5	6
7	8	9	10	11	12	13
14	15	16	17	18	19	20
21	22	23	24	25	26	27
28	29	30	31			

February 2019
20 days included

Mon	Tue	Wed	Thu	Fri	Sat	Sun
				1	2	3
4	5	6	7	8	9	10
11	12	13	14	15	16	17
18	19	20	21	22	23	24
25	26	27	28			

March 2019
21 days included

Mon	Tue	Wed	Thu	Fri	Sat	Sun
				1	2	3
4	5	6	7	8	9	10
11	12	13	14	15	16	17
18	19	20	21	22	23	24
25	26	27	28	29	30	31

April 2019
20 days included

Mon	Tue	Wed	Thu	Fri	Sat	Sun
1	2	3	4	5	6	7
8	9	10	11	12	13	14
15	16	17	18	19	20	21
22	23	24	25	26	27	28
29	30					

May 2019
22 days included

Mon	Tue	Wed	Thu	Fri	Sat	Sun
		1	2	3	4	5
6	7	8	9	10	11	12
13	14	15	16	17	18	19
20	21	22	23	24	25	26
27	28	29	30	31		

June 2019
19 days included

Mon	Tue	Wed	Thu	Fri	Sat	Sun
					1	2
3	4	5	6	7	8	9
10	11	12	13	14	15	16
17	18	19	20	21	22	23
24	25	26	27	28	29	30

July 2019
23 days included

Mon	Tue	Wed	Thu	Fri	Sat	Sun
1	2	3	4	5	6	7
8	9	10	11	12	13	14
15	16	17	18	19	20	21
22	23	24	25	26	27	28
29	30	31				

August 2019
21 days included

Mon	Tue	Wed	Thu	Fri	Sat	Sun
			1	2	3	4
5	6	7	8	9	10	11
12	13	14	15	16	17	18
19	20	21	22	23	24	25
26	27	28	29	30	31	

September 2019
20 days included

Mon	Tue	Wed	Thu	Fri	Sat	Sun
						1
2	3	4	5	6	7	8
9	10	11	12	13	14	15
16	17	18	19	20	21	22
23	24	25	26	27	28	29
30						

October 2019
23 days included

Mon	Tue	Wed	Thu	Fri	Sat	Sun
	1	2	3	4	5	6
7	8	9	10	11	12	13
14	15	16	17	18	19	20
21	22	23	24	25	26	27
28	29	30	31			

November 2019
21 days included

Mon	Tue	Wed	Thu	Fri	Sat	Sun
				1	2	3
4	5	6	7	8	9	10
11	12	13	14	15	16	17
18	19	20	21	22	23	24
25	26	27	28	29	30	

December 2019
15 days included

Mon	Tue	Wed	Thu	Fri	Sat	Sun
						1
2	3	4	5	6	7	8
9	10	11	12	13	14	15
16	17	18	19	20	21	22
23	24	25	26	27	28	29
30	31					

11/06/18

cms-tc-planning@cern.ch

Working Days 2020

January 2020
20 days included

Mon	Tue	Wed	Thu	Fri	Sat	Sun
		1	2	3	4	5
6	7	8	9	10	11	12
13	14	15	16	17	18	19
20	21	22	23	24	25	26
27	28	29	30	31		

February 2020
20 days included

Mon	Tue	Wed	Thu	Fri	Sat	Sun
					1	2
3	4	5	6	7	8	9
10	11	12	13	14	15	16
17	18	19	20	21	22	23
24	25	26	27	28	29	

March 2020
22 days included

Mon	Tue	Wed	Thu	Fri	Sat	Sun
						1
2	3	4	5	6	7	8
9	10	11	12	13	14	15
16	17	18	19	20	21	22
23	24	25	26	27	28	29
30	31					

April 2020
20 days included

Mon	Tue	Wed	Thu	Fri	Sat	Sun
		1	2	3	4	5
6	7	8	9	10	11	12
13	14	15	16	17	18	19
20	21	22	23	24	25	26
27	28	29	30			

May 2020
20 days included

Mon	Tue	Wed	Thu	Fri	Sat	Sun
				1	2	3
4	5	6	7	8	9	10
11	12	13	14	15	16	17
18	19	20	21	22	23	24
25	26	27	28	29	30	31

June 2020
21 days included

Mon	Tue	Wed	Thu	Fri	Sat	Sun
1	2	3	4	5	6	7
8	9	10	11	12	13	14
15	16	17	18	19	20	21
22	23	24	25	26	27	28
29	30					

July 2020
23 days included

Mon	Tue	Wed	Thu	Fri	Sat	Sun
		1	2	3	4	5
6	7	8	9	10	11	12
13	14	15	16	17	18	19
20	21	22	23	24	25	26
27	28	29	30	31		

August 2020
21 days included

Mon	Tue	Wed	Thu	Fri	Sat	Sun
					1	2
3	4	5	6	7	8	9
10	11	12	13	14	15	16
17	18	19	20	21	22	23
24	25	26	27	28	29	30
31						

September 2020
21 days included

Mon	Tue	Wed	Thu	Fri	Sat	Sun
	1	2	3	4	5	6
7	8	9	10	11	12	13
14	15	16	17	18	19	20
21	22	23	24	25	26	27
28	29	30				

October 2020
22 days included

Mon	Tue	Wed	Thu	Fri	Sat	Sun
			1	2	3	4
5	6	7	8	9	10	11
12	13	14	15	16	17	18
19	20	21	22	23	24	25
26	27	28	29	30	31	

November 2020
21 days included

Mon	Tue	Wed	Thu	Fri	Sat	Sun
						1
2	3	4	5	6	7	8
9	10	11	12	13	14	15
16	17	18	19	20	21	22
23	24	25	26	27	28	29
30						

December 2020
16 days included

Mon	Tue	Wed	Thu	Fri	Sat	Sun
	1	2	3	4	5	6
7	8	9	10	11	12	13
14	15	16	17	18	19	20
21	22	23	24	25	26	27
28	29	30	31			

Working Days 2021

January 2021						
20 days included						
Mon	Tue	Wed	Thu	Fri	Sat	Sun
				1	2	3
4	5	6	7	8	9	10
11	12	13	14	15	16	17
18	19	20	21	22	23	24
25	26	27	28	29	30	31

February 2021						
20 days included						
Mon	Tue	Wed	Thu	Fri	Sat	Sun
1	2	3	4	5	6	7
8	9	10	11	12	13	14
15	16	17	18	19	20	21
22	23	24	25	26	27	28



Crane

Cryo.	█	EL power	█	Water cool.	█	Database	█								
IT	█	Magnet	█	C6F14	█	Gas	█								
SL.	3	GEM	█	ECAL	█	ZEC	█	DT+ RB	█	Survey	█	TE-VSC	█	SMB	█
CP.	0	TOTEM	█	CMX	█	CSC RE	█	TK PIX	█	HCAL	█	EN Dept	█	RP	█

PX56 Plug CLOSED
TX54 Plug CLOSED

Monday
03. December 2018

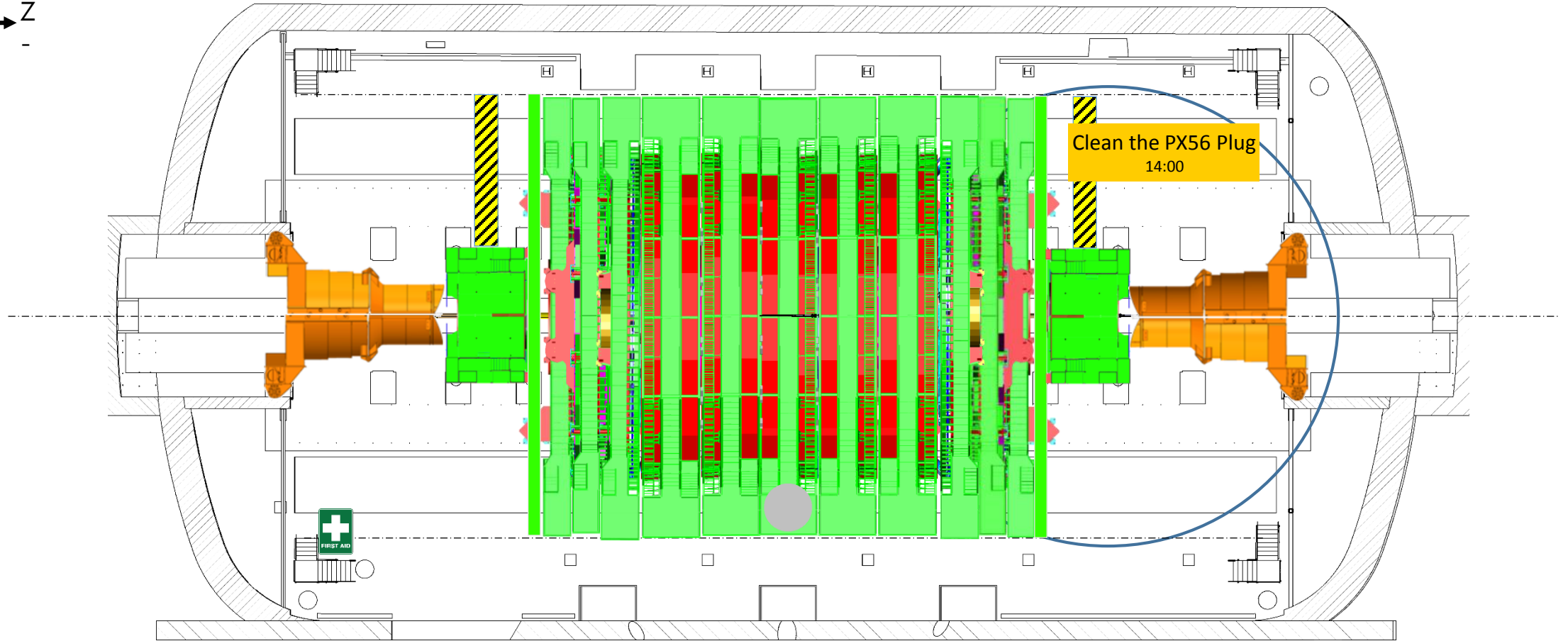
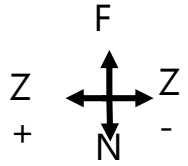

Install shelf for PPE/EPI in UP55
Maf + RTecs 2h

5m



Cryo.	■	EL power	■	Water cool.	■	Database	■	
IT	■	Magnet	■	C6F14	■	Gas	■	
SL.	3	GEM	ECAL	ZEC	DT+ RB	Survey	TE-VSC	SMB
CP.	0	TOTEM	CMX	CSC RE	TK PIX	HCAL	EN Dept	RP

PX56 Plug
OPEN

TX54 Plug
CLOSED

Tuesday

04. December 2018

Crane

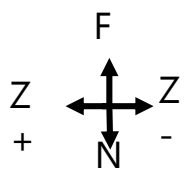

Working underground after 19:00? Call 165000!

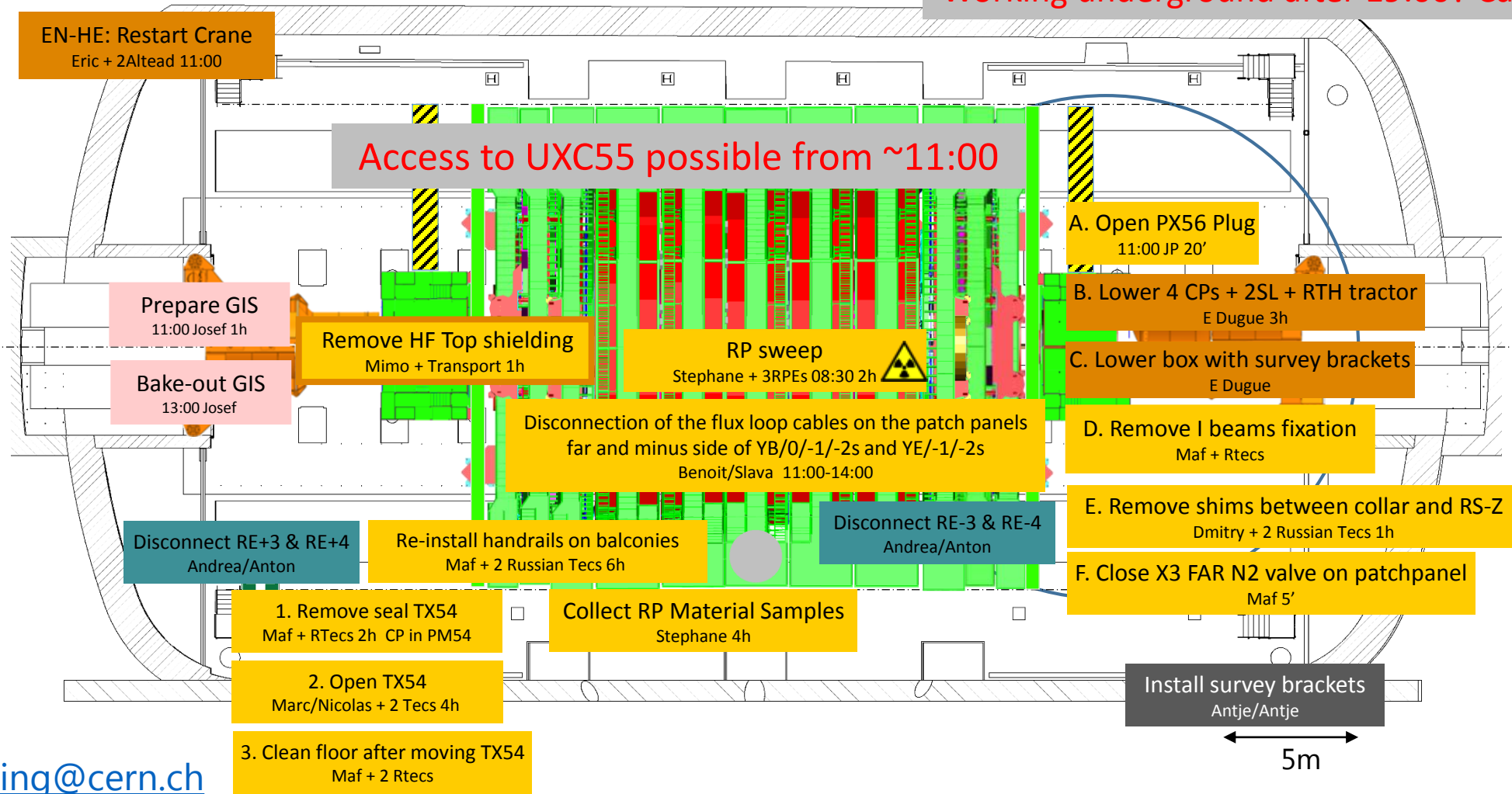

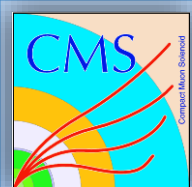

Cryo.	EL power	Water cool.	Database				
IT	Magnet	C6F14	Gas				
SL. 0	GEM	ECAL	ZEC	DT+ RB	Survey	TE-VSC	SMB
CP. 0	TOTEM	CMX	CSC RE	TK PIX	HCAL	EN Dept	RP

PX56 Plug OPEN

Wednesday

TX54 Plug OPEN

05. December 2018

Crane

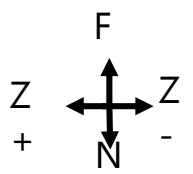

Working underground after 19:00? Call 165000!

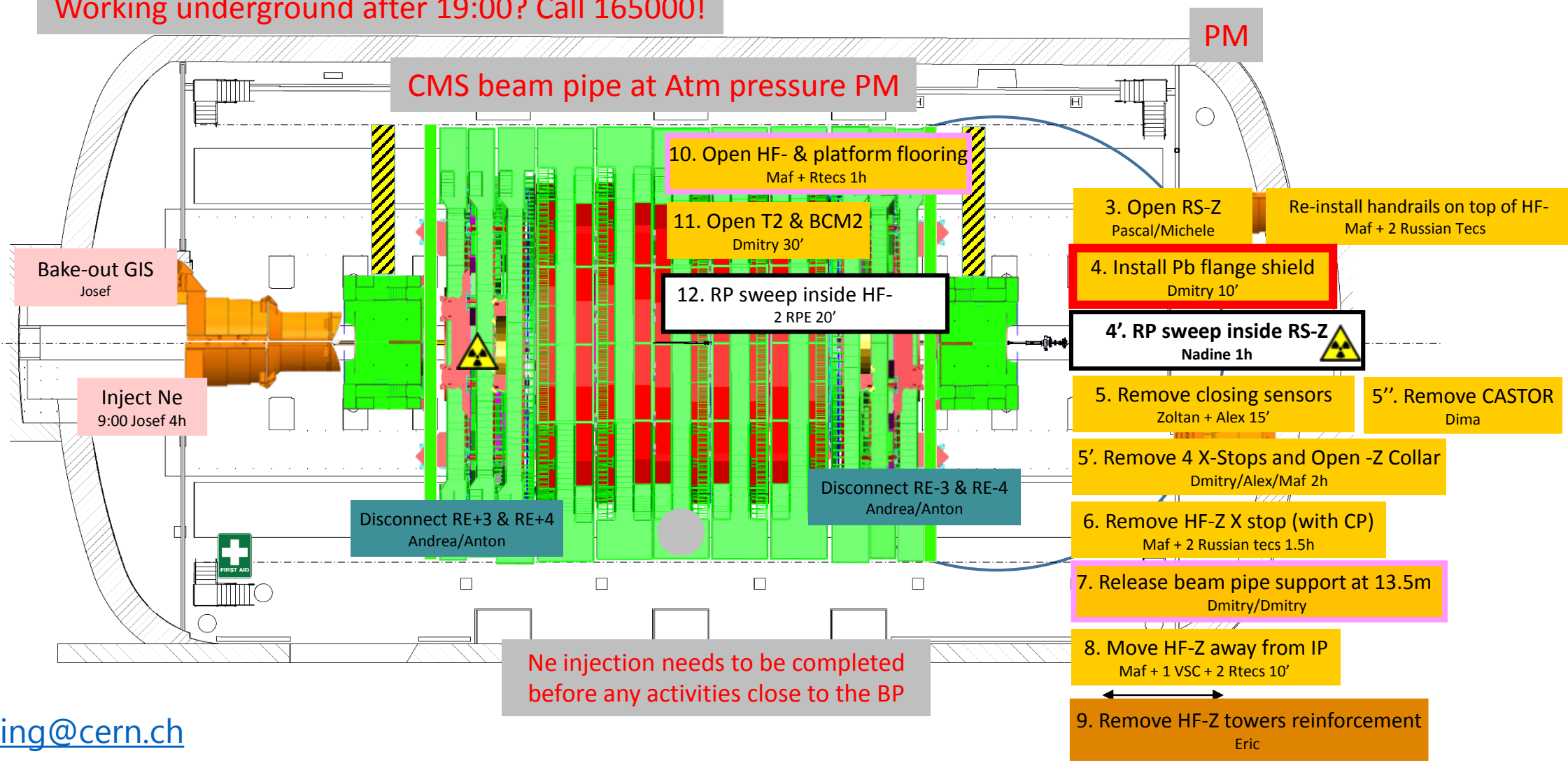



Crane

Cryo.	EL power	Water cool.	Database				
IT	Magnet	C6F14	Gas				
SL. 0	GEM	ECAL	ZEC	DT+ RB	Survey	TE-VSC	SMB
CP. 0	TOTEM	CMX	CSC RE	TK PIX	HCAL	EN Dept	RP

PX56 Plug OPEN

Thursday

TX54 Plug OPEN

06. December 2018

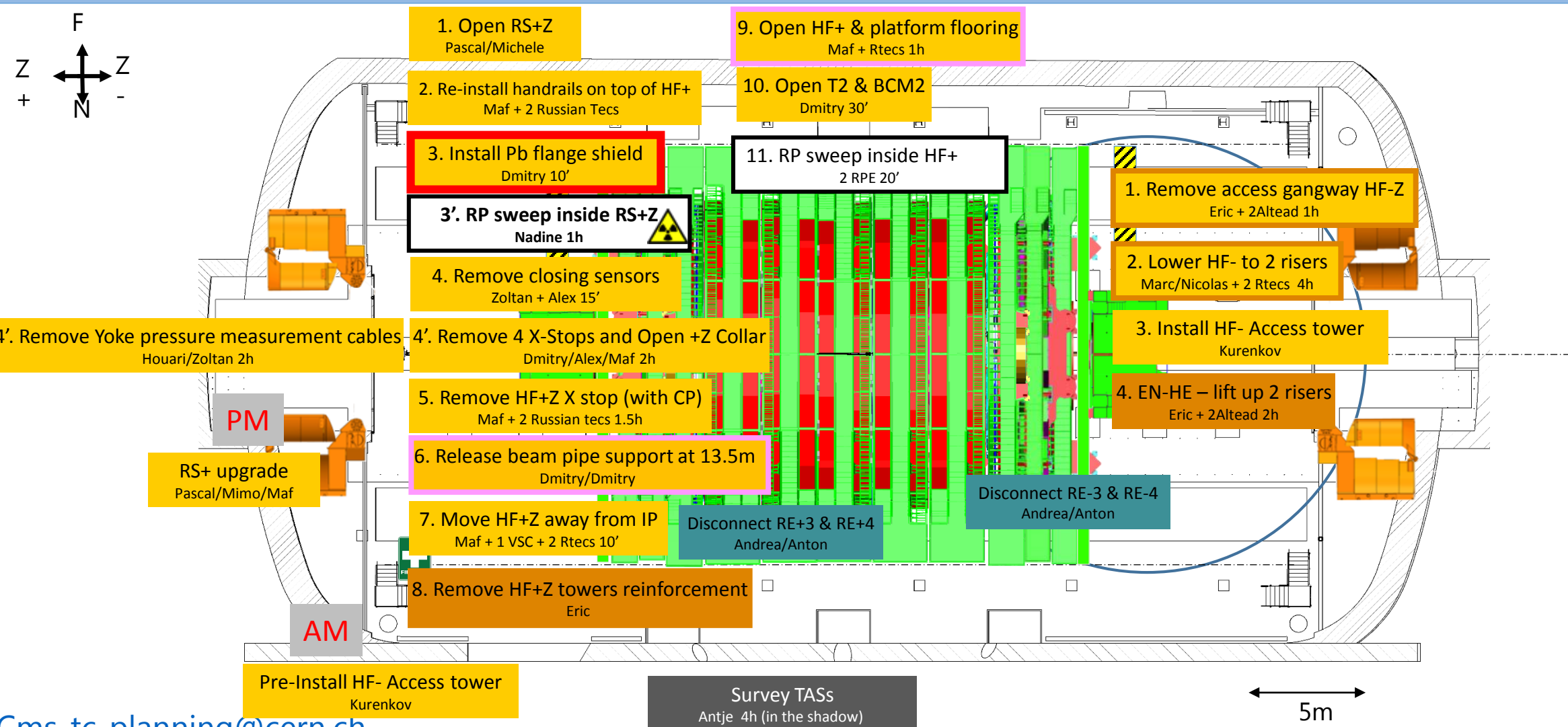
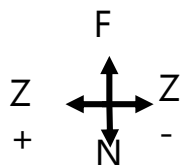



Crane

Cryo.	EL power	Water cool.	Database				
IT	Magnet	C6F14	Gas				
SL. 0	GEM	ECAL	ZEC	DT+ RB	Survey	TE-VSC	SMB
CP. 0	TOTEM	CMX	CSC RE	TK PIX	HCAL	EN Dept	RP

PX56 Plug OPEN

Friday

TX54 Plug OPEN

07. December 2018

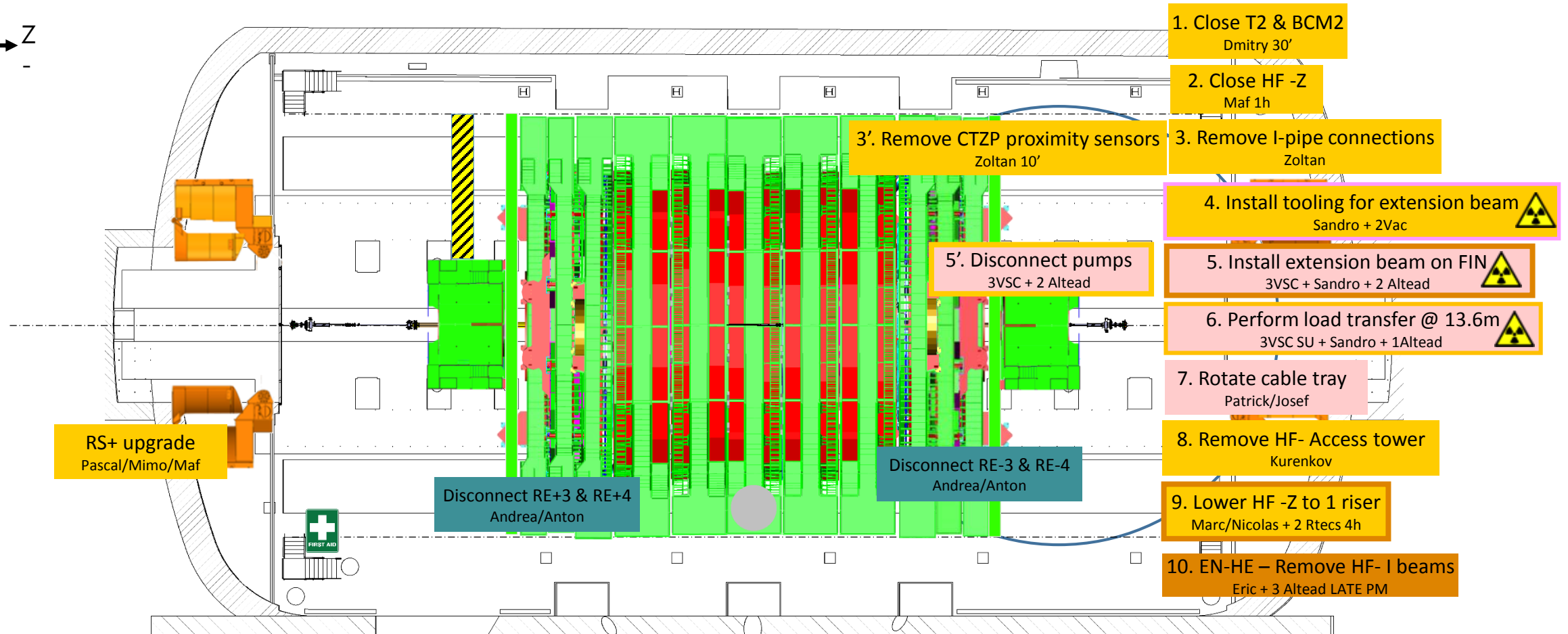
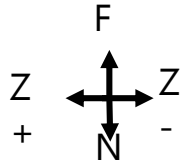

5m



Crane

Cryo.	EL power	Water cool.	Database				
IT	Magnet	C6F14	Gas				
SL. 0	GEM	ECAL	ZEC	DT+ RB	Survey	TE-VSC	SMB
CP. 0	TOTEM	CMX	CSC RE	TK PIX	HCAL	EN Dept	RP

PX56 Plug OPEN
TX54 Plug OPEN

Saturday
08. December 2018

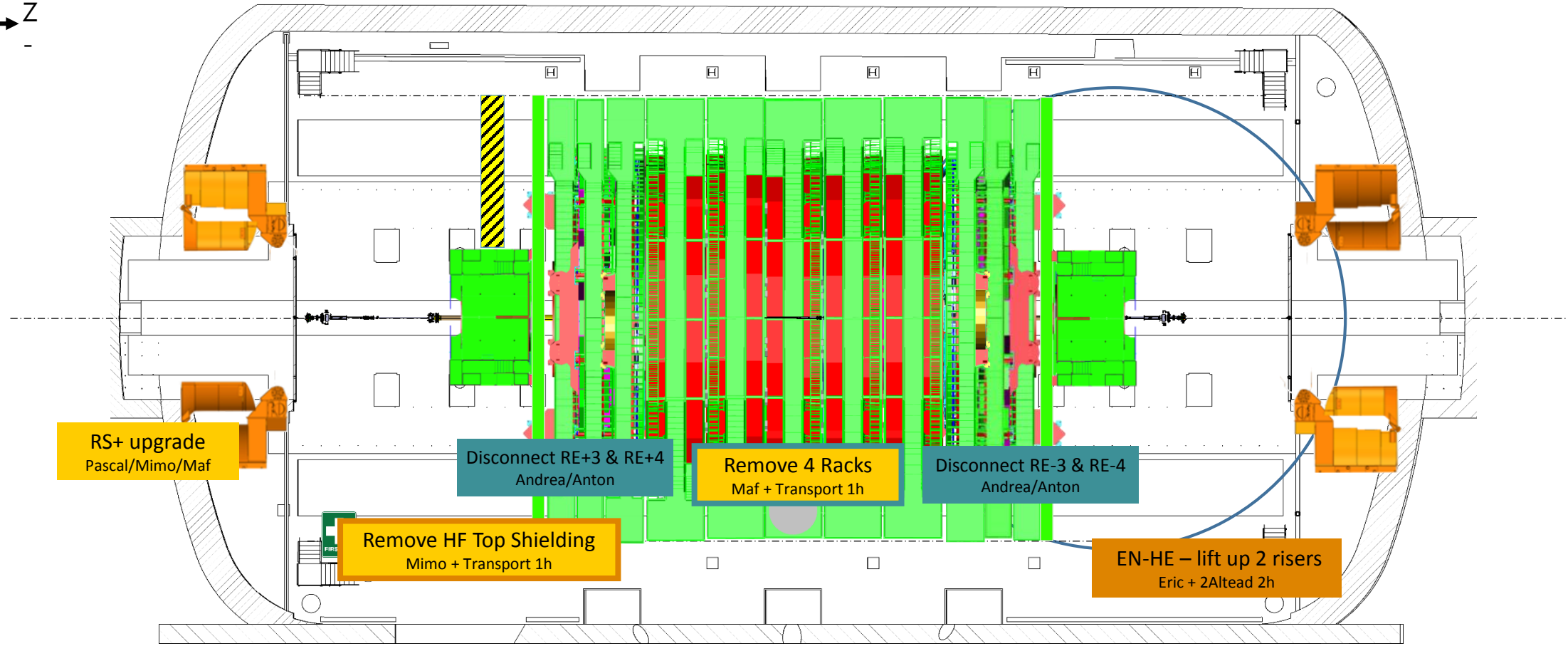
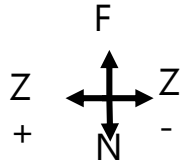

RS+ upgrade
Pascal/Mimo/Maf

Disconnect RE+3 & RE+4
Andrea/Anton

Remove 4 Racks
Maf + Transport 1h

Disconnect RE-3 & RE-4
Andrea/Anton

Remove HF Top Shielding
Mimo + Transport 1h

EN-HE – lift up 2 risers
Eric + 2Altead 2h

5m



Crane

Cryo.	EL power	Water cool.	Database				
IT	Magnet	C6F14	Gas				
SL. 0	GEM	ECAL	ZEC	DT+ RB	Survey	TE-VSC	SMB
CP. 0	TOTEM	CMX	CSC RE	TK PIX	HCAL	EN Dept	RP

PX56 Plug OPEN
TX54 Plug OPEN

Sunday
09. December 2018

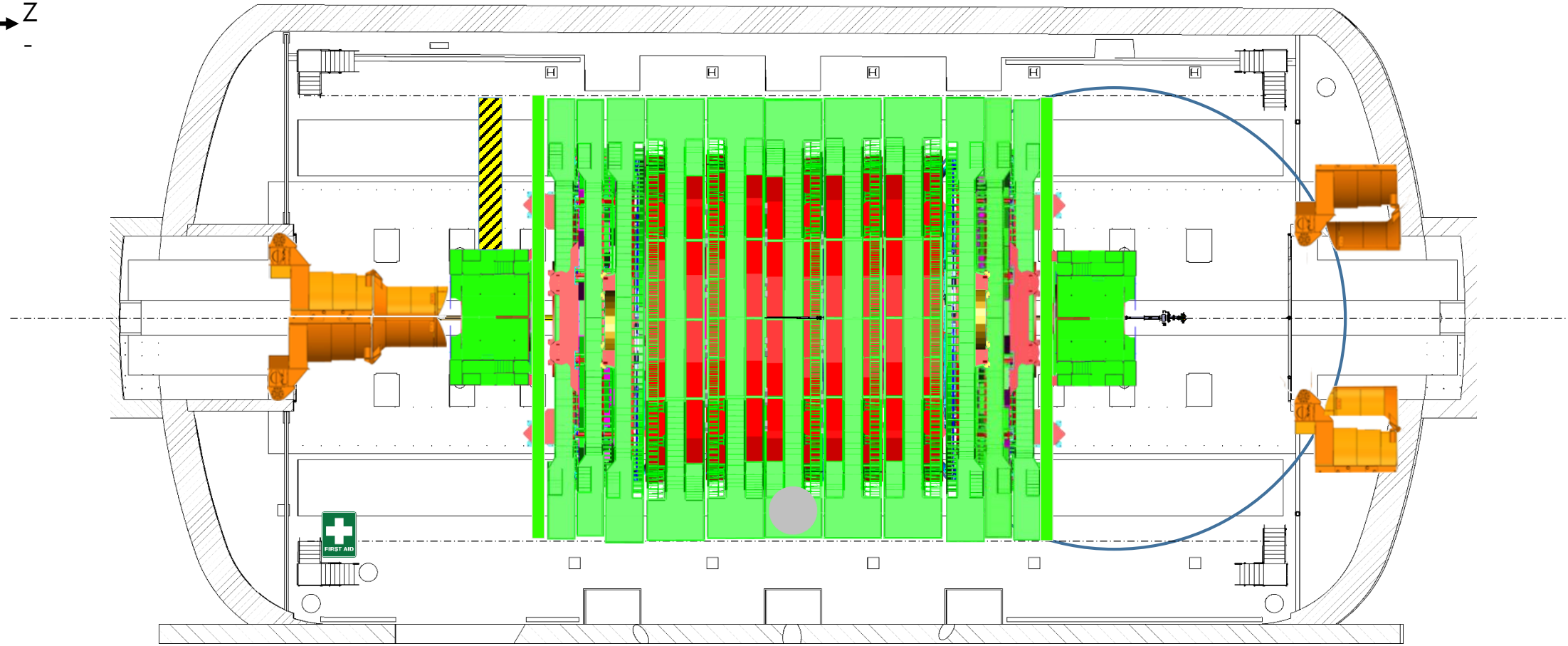
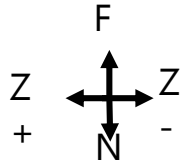

5m



Crane

Cryo.	EL power	Water cool.	Database				
IT	Magnet	C6F14	Gas				
SL. 0	GEM	ECAL	ZEC	DT+ RB	Survey	TE-VSC	SMB
CP. 0	TOTEM	CMX	CSC RE	TK PIX	HCAL	EN Dept	RP

PX56 Plug OPEN

TX54 Plug OPEN

Monday

10. December 2018

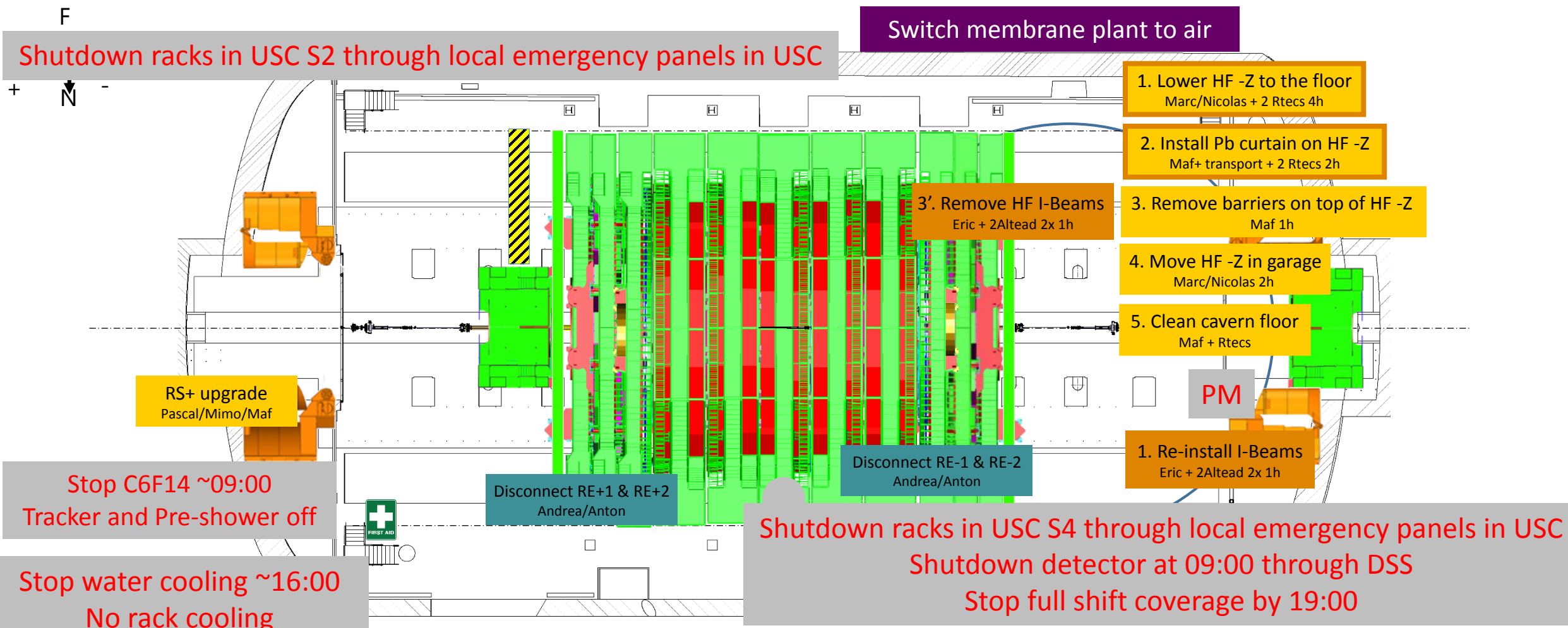

Stop C6F14 ~09:00
Tracker and Pre-shower off

Stop water cooling ~16:00
No rack cooling
Safety systems on tap-water

CMS-tc-planning@cern.ch

Survey TAS-
Antje 4h (in the shadow) d

5

1. Prepare to move YE-
Marc/Nicolas 4h



Crane

Cryo.	EL power	Water cool.	Database				
IT	Magnet	C6F14	Gas				
SL. 0	GEM	ECAL	ZEC	DT+ RB	Survey	TE-VSC	SMB
CP. 0	TOTEM	CMX	CSC RE	TK PIX	HCAL	EN Dept	RP

PX56 Plug
OPEN

Tuesday

TX54 Plug
OPEN

11. December 2018

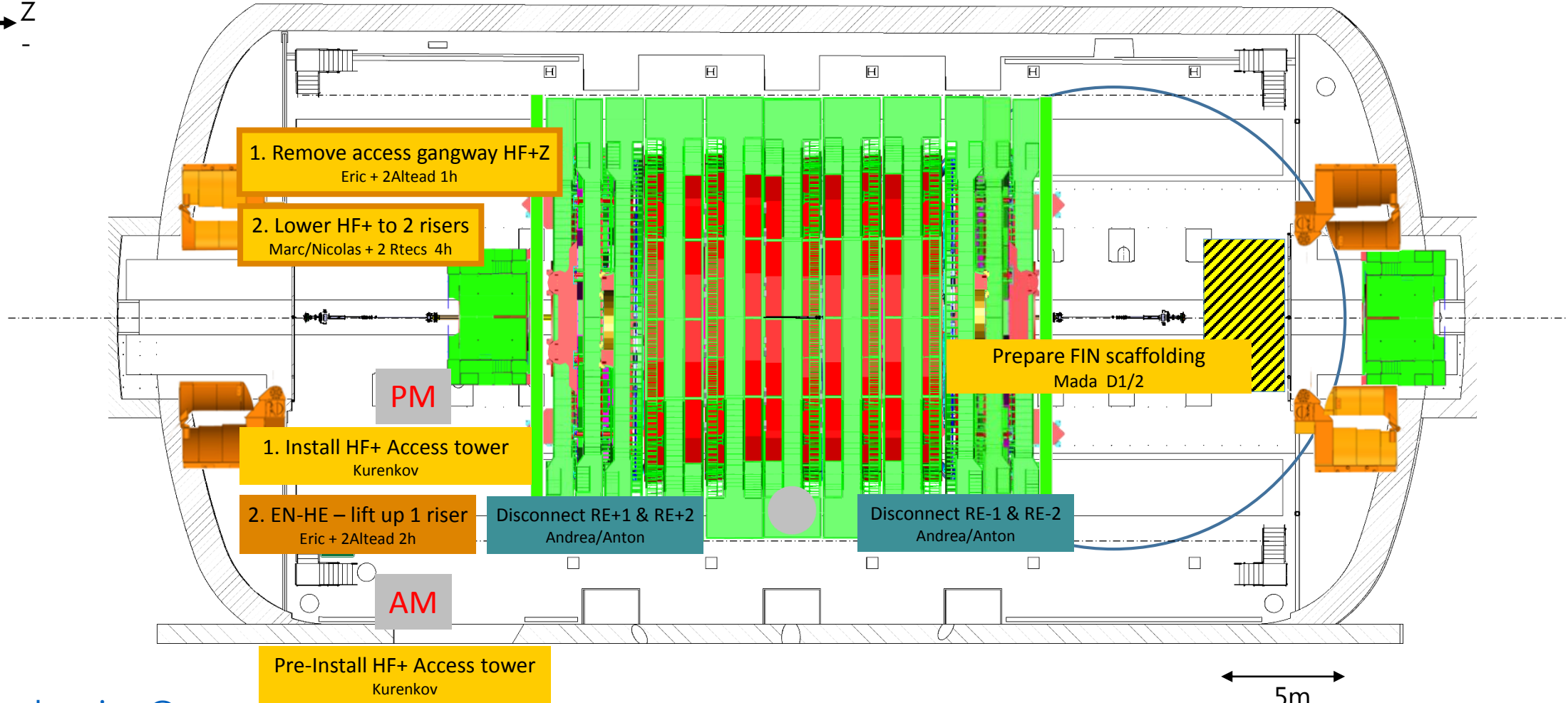
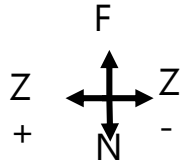

5m



Crane

Cryo.	■	EL power	■	Water cool.	■	Database	■								
IT	■	Magnet	■	C6F14	■	Gas	■								
SL.	0	GEM	■	ECAL	■	ZEC	■	DT+ RB	■	Survey	■	TE-VSC	■	SMB	■
CP.	0	TOTEM	■	CMX	■	CSC RE	■	TK PIX	■	HCAL	■	EN Dept	■	RP	■

PX56 Plug
OPEN

TX54 Plug
OPEN

Wednesday

12. December 2018

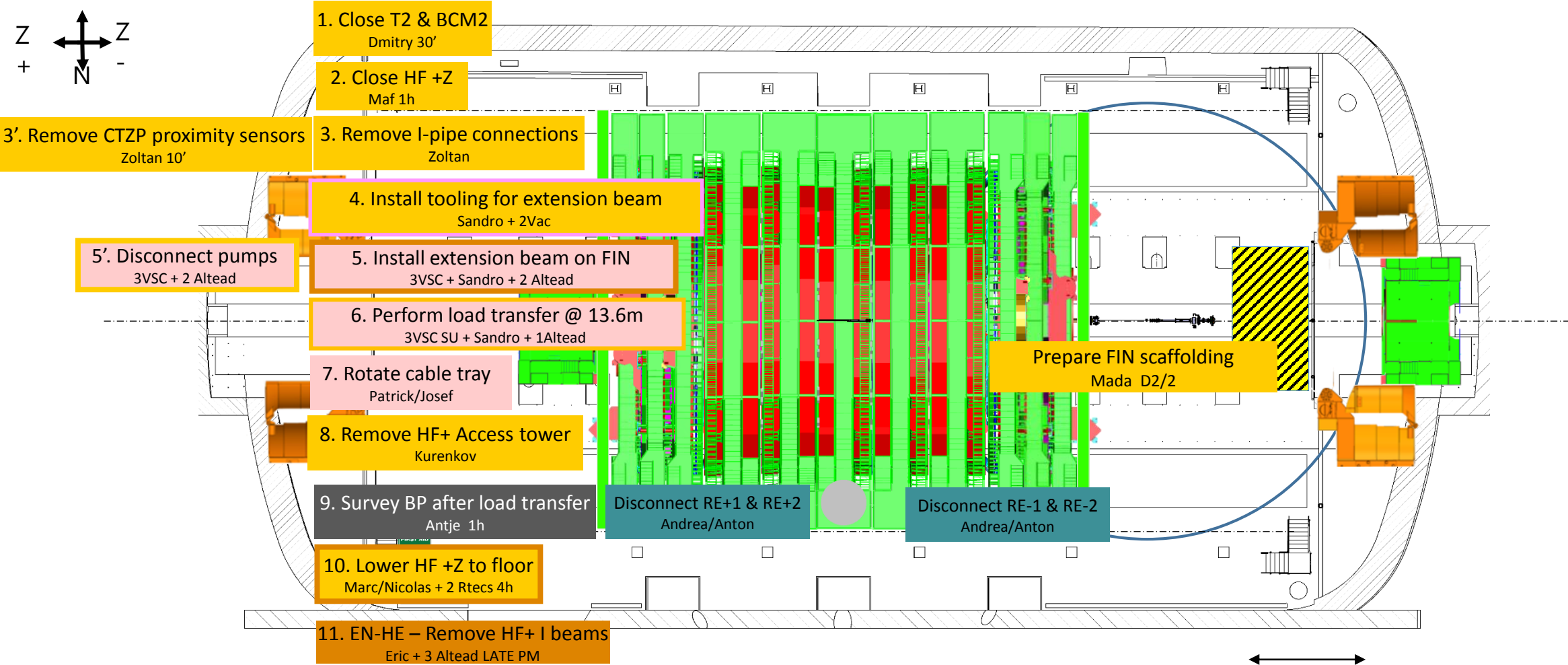
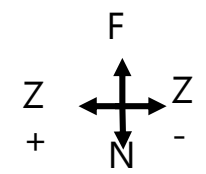

5m



Crane

Cryo.	EL power	Water cool.	Database				
IT	Magnet	C6F14	Gas				
SL. 0	GEM	ECAL	ZEC	DT+ RB	Survey	TE-VSC	SMB
CP. 0	TOTEM	CMX	CSC RE	TK PIX	HCAL	EN Dept	RP

PX56 Plug
OPEN

TX54 Plug
OPEN

Thursday

13. December 2018

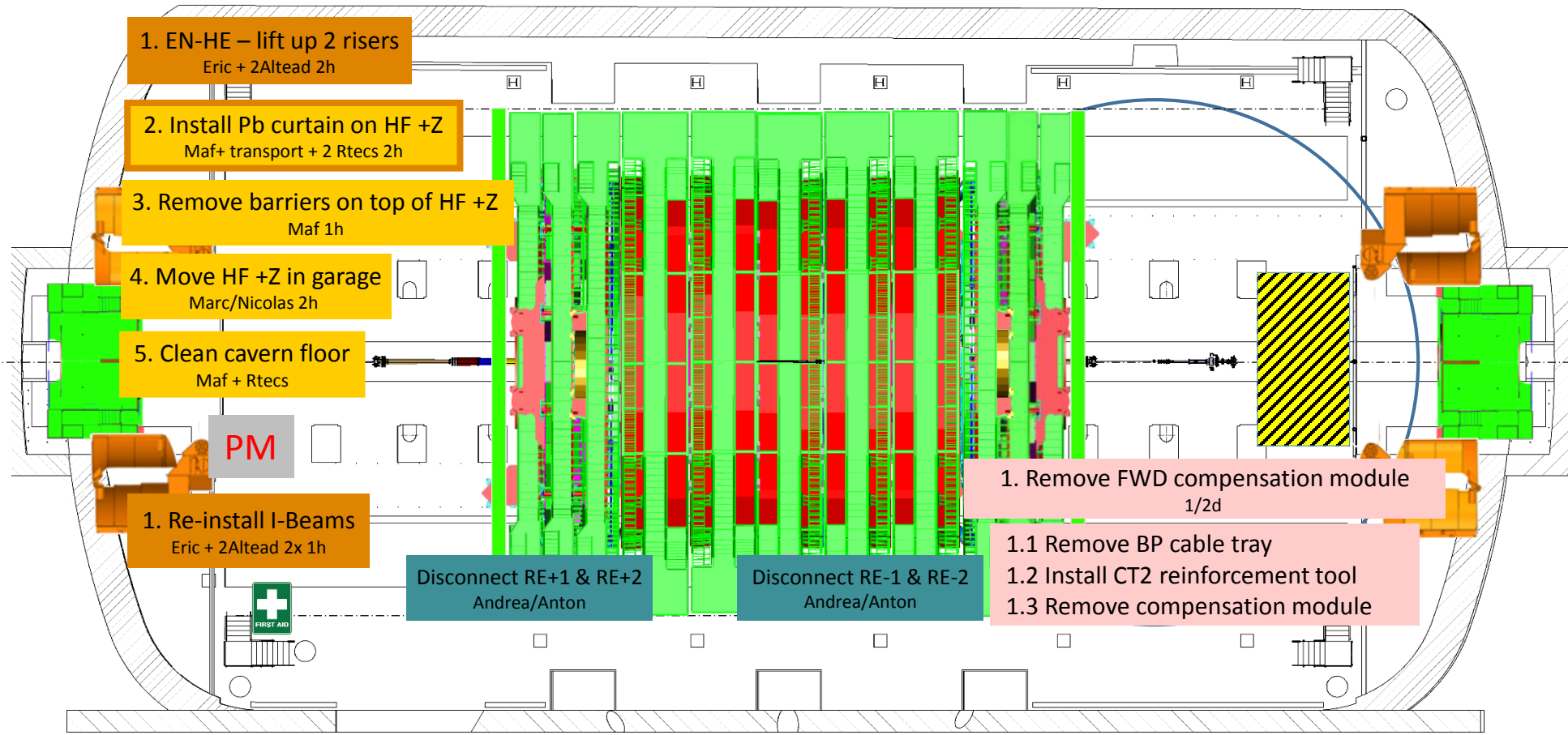
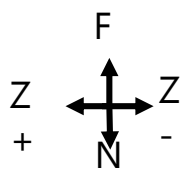

1. EN-HE – lift up 2 risers
Eric + 2Altead 2h

2. Install Pb curtain on HF +Z
Maf+ transport + 2 Rtecs 2h

3. Remove barriers on top of HF +Z
Maf 1h

4. Move HF +Z in garage
Marc/Nicolas 2h

5. Clean cavern floor
Maf + Rtecs

1. Re-install I-Beams
Eric + 2Altead 2x 1h

Disconnect RE+1 & RE+2
Andrea/Anton

Disconnect RE-1 & RE-2
Andrea/Anton

1. Remove FWD compensation module
1/2d

1.1 Remove BP cable tray
1.2 Install CT2 reinforcement tool
1.3 Remove compensation module



Crane

Cryo.	EL power	Water cool.	Database				
IT	Magnet	C6F14	Gas				
SL. 0	GEM	ECAL	ZEC	DT+ RB	Survey	TE-VSC	SMB
CP. 0	TOTEM	CMX	CSC RE	TK PIX	HCAL	EN Dept	RP

PX56 Plug OPEN
TX54 Plug OPEN

Friday
14. December 2018

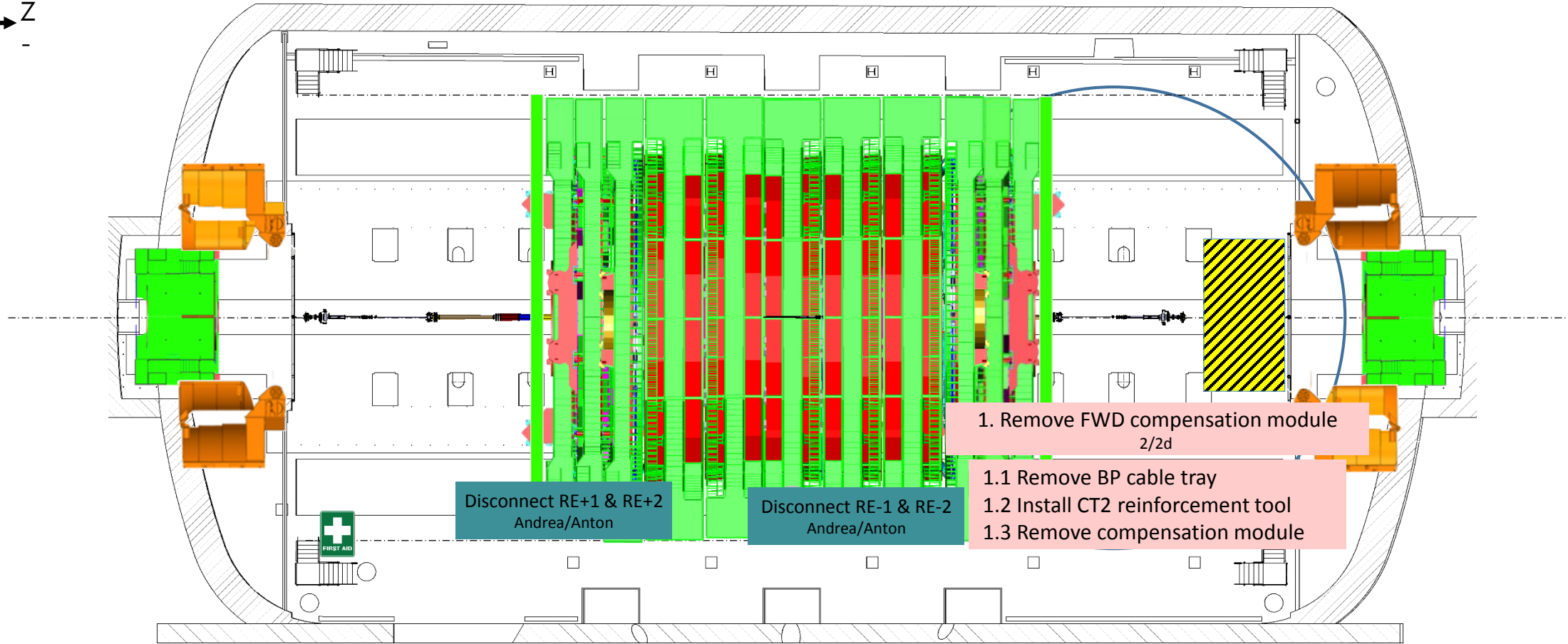
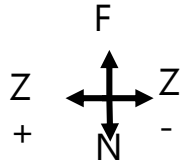

Disconnect RE+1 & RE+2
Andrea/Anton

Disconnect RE-1 & RE-2
Andrea/Anton

1. Remove FWD compensation module 2/2d
- 1.1 Remove BP cable tray
- 1.2 Install CT2 reinforcement tool
- 1.3 Remove compensation module

5m



Crane

Cryo.	EL power	Water cool.	Database				
IT	Magnet	C6F14	Gas				
SL. 0	GEM	ECAL	ZEC	DT+ RB	Survey	TE-VSC	SMB
CP. 0	TOTEM	CMX	CSC RE	TK PIX	HCAL	EN Dept	RP

PX56 Plug OPEN
TX54 Plug OPEN

Saturday
15. December 2018

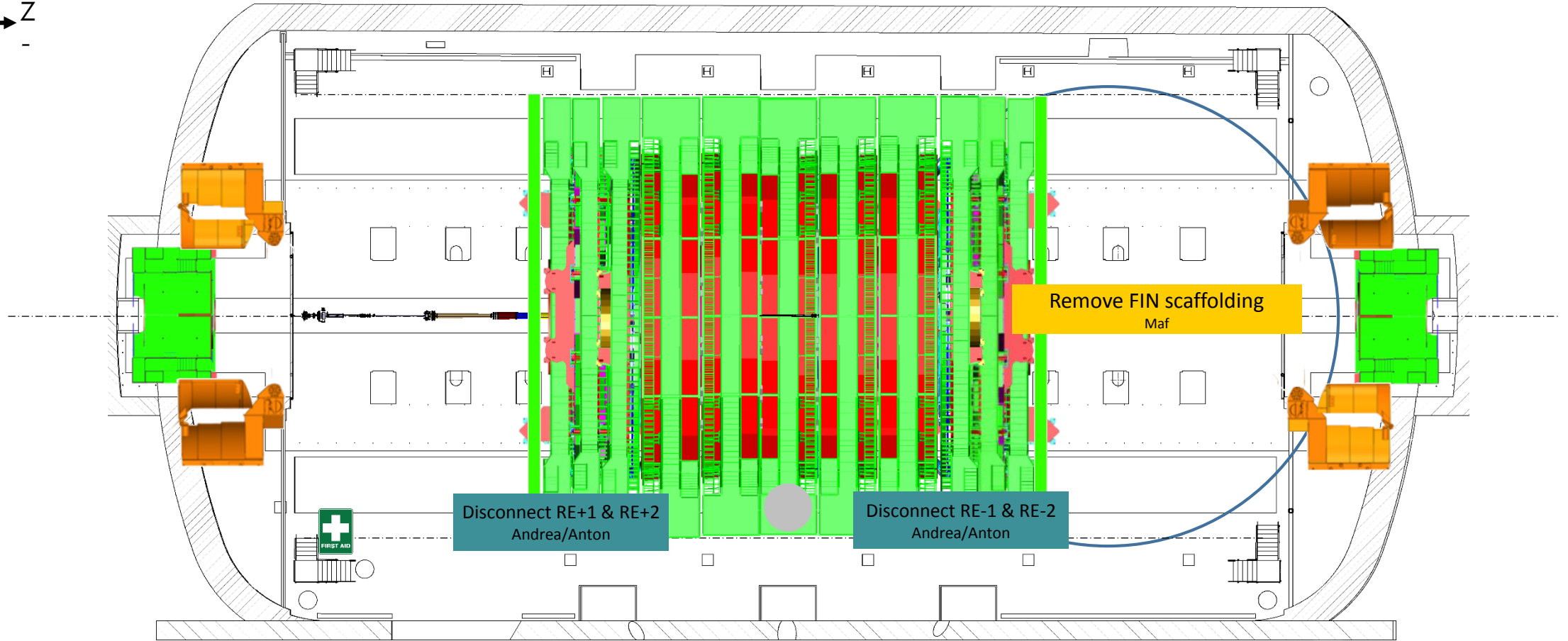
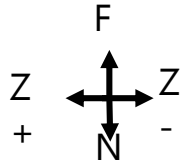

5m



Crane

Cryo.	EL power	Water cool.	Database				
IT	Magnet	C6F14	Gas				
SL. 0	GEM	ECAL	ZEC	DT+ RB	Survey	TE-VSC	SMB
CP. 0	TOTEM	CMX	CSC RE	TK PIX	HCAL	EN Dept	RP

PX56 Plug OPEN
TX54 Plug OPEN

Sunday
16. December 2018

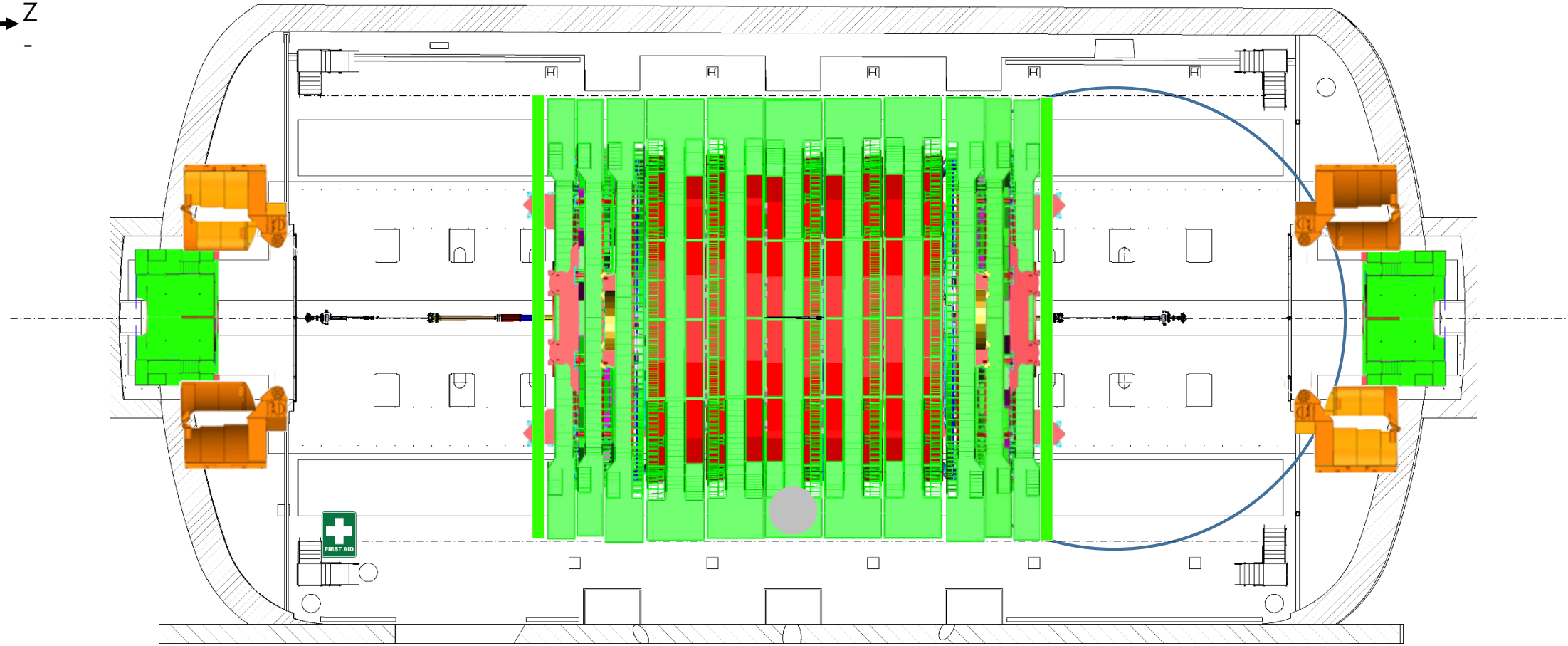
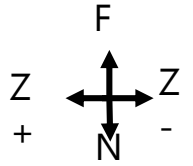

5m



Crane

Cryo.	EL power	Water cool.	Database				
IT	Magnet	C6F14	Gas				
SL. 0	GEM	ECAL	ZEC	DT+ RB	Survey	TE-VSC	SMB
CP. 0	TOTEM	CMX	CSC RE	TK PIX	HCAL	EN Dept	RP

PX56 Plug OPEN
TX54 Plug OPEN

Monday
17. December 2018

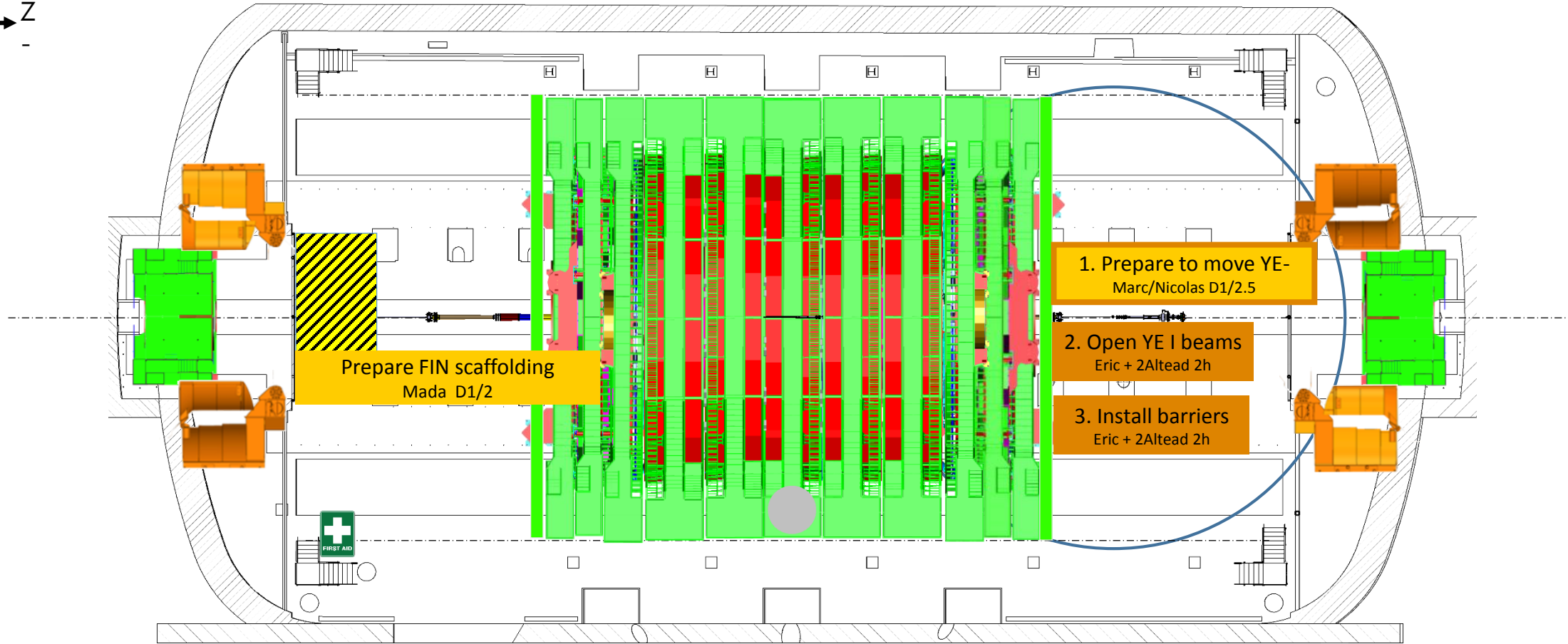
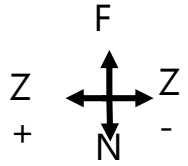

Prepare FIN scaffolding
Mada D1/2

1. Prepare to move YE-Marc/Nicolas D1/2.5
2. Open YE I beams
Eric + 2Altead 2h
3. Install barriers
Eric + 2Altead 2h

5m



Crane

Cryo.	EL power	Water cool.	Database				
IT	Magnet	C6F14	Gas				
SL. 0	GEM	ECAL	ZEC	DT+ RB	Survey	TE-VSC	SMB
CP. 0	TOTEM	CMX	CSC RE	TK PIX	HCAL	EN Dept	RP

PX56 Plug
OPEN

Tuesday

TX54 Plug
OPEN

18. December 2018

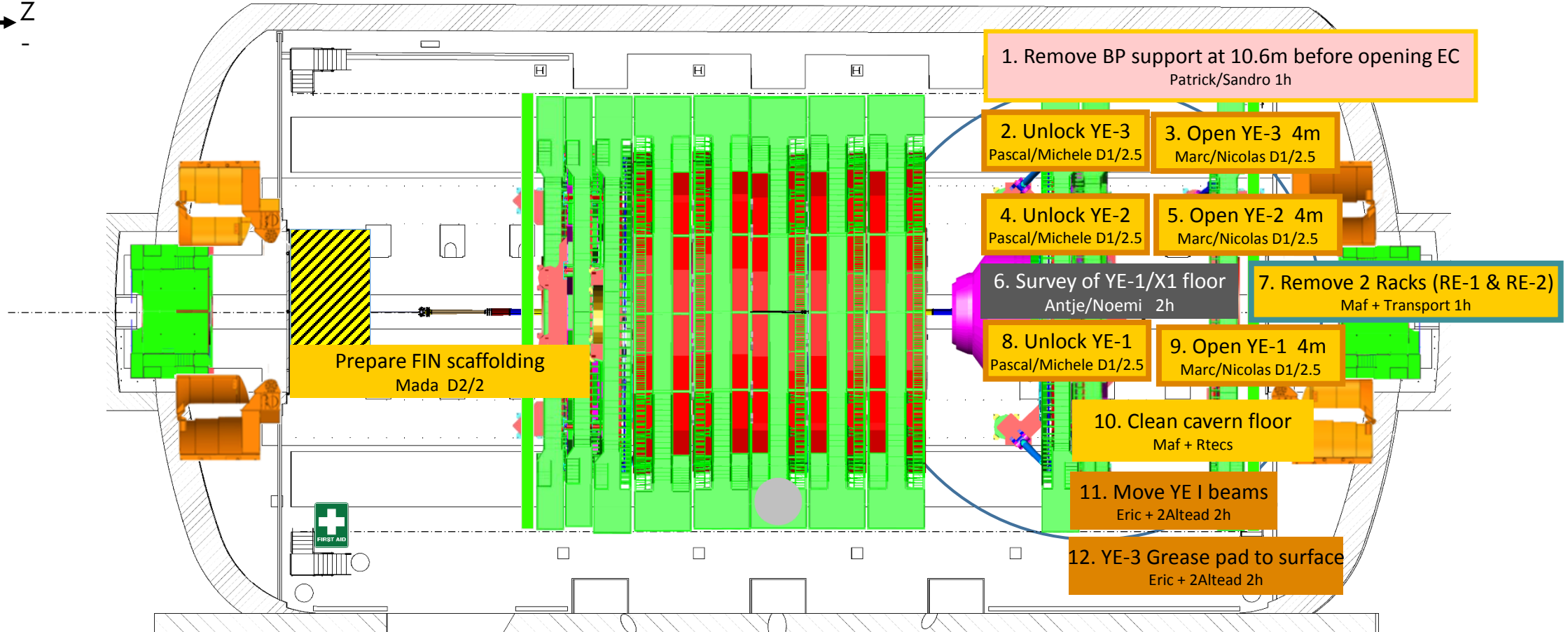
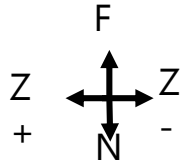

5m



Crane

Cryo.	EL power	Water cool.	Database				
IT	Magnet	C6F14	Gas				
SL. 0	GEM	ECAL	ZEC	DT+ RB	Survey	TE-VSC	SMB
CP. 0	TOTEM	CMX	CSC RE	TK PIX	HCAL	EN Dept	RP

PX56 Plug
OPEN

TX54 Plug
OPEN

Wednesday

19. December 2018

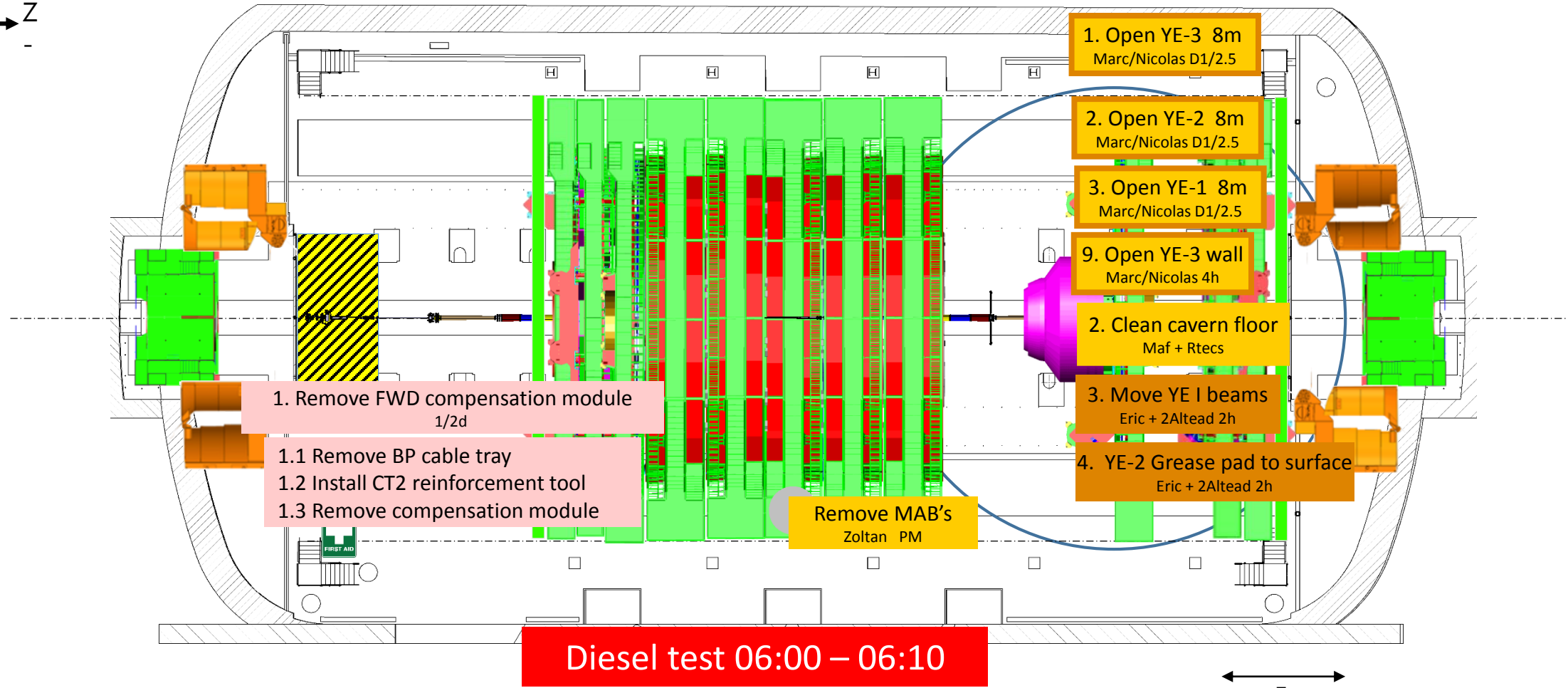

1. Open YE-3 8m
Marc/Nicolas D1/2.5

2. Open YE-2 8m
Marc/Nicolas D1/2.5

3. Open YE-1 8m
Marc/Nicolas D1/2.5

9. Open YE-3 wall
Marc/Nicolas 4h

2. Clean cavern floor
Maf + Rtecs

3. Move YE I beams
Eric + 2Altead 2h

4. YE-2 Grease pad to surface
Eric + 2Altead 2h

1. Remove FWD compensation module
1/2d

1.1 Remove BP cable tray
1.2 Install CT2 reinforcement tool
1.3 Remove compensation module

Remove MAB's
Zoltan PM

Diesel test 06:00 – 06:10

5m



Crane

Cryo.	EL power	Water cool.	Database				
IT	Magnet	C6F14	Gas				
SL. 0	GEM	ECAL	ZEC	DT+ RB	Survey	TE-VSC	SMB
CP. 0	TOTEM	CMX	CSC RE	TK PIX	HCAL	EN Dept	RP

PX56 Plug
OPEN

TX54 Plug
OPEN

Thursday

20. December 2018

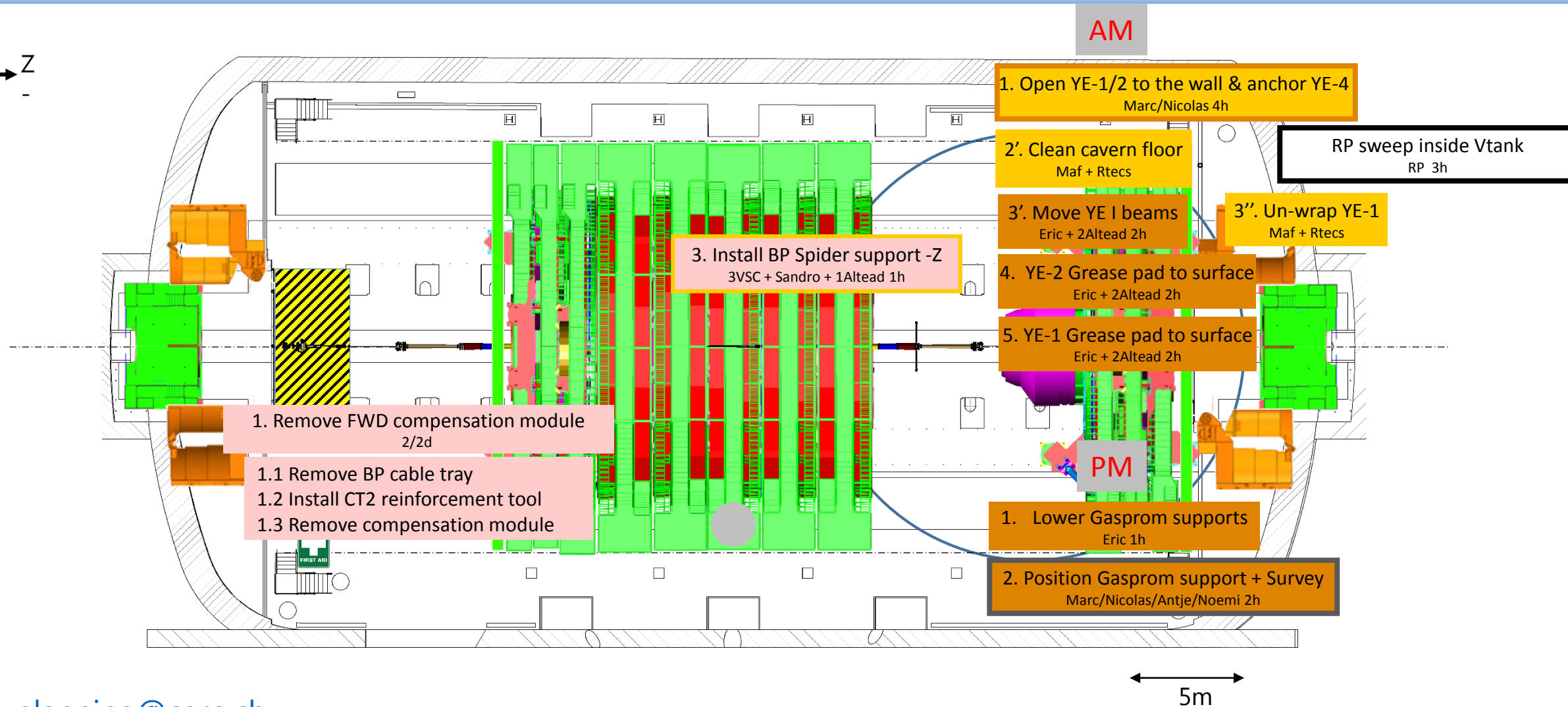
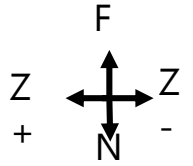

5m



Crane

Cryo.	EL power	Water cool.	Database				
IT	Magnet	C6F14	Gas				
SL. 0	GEM	ECAL	ZEC	DT+ RB	Survey	TE-VSC	SMB
CP. 0	TOTEM	CMX	CSC RE	TK PIX	HCAL	EN Dept	RP

PX56 Plug OPEN
TX54 Plug OPEN

Friday
21. December 2018

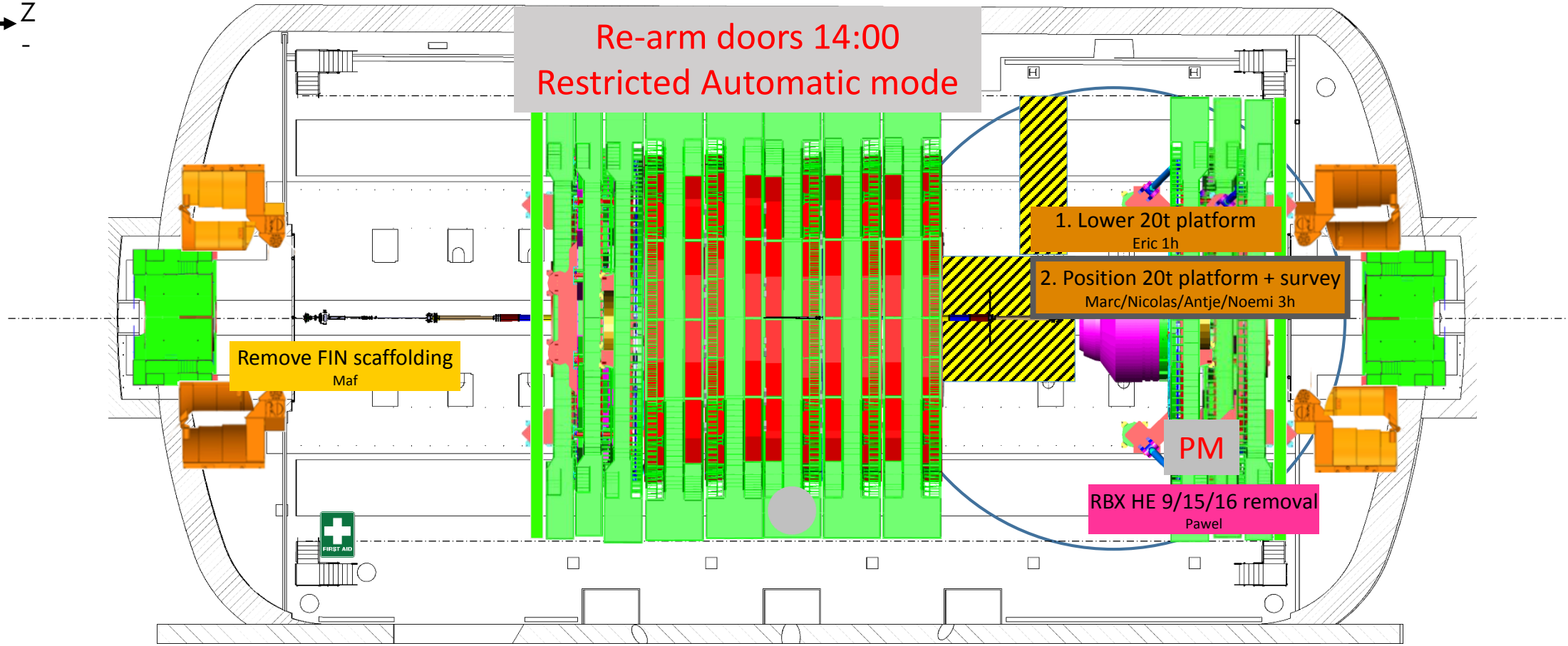
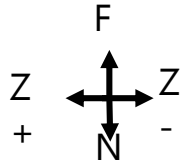

5m



Cryo.	EL power	Water cool.	Database				
IT	Magnet	C6F14	Gas				
SL. 0	GEM	ECAL	ZEC	DT+ RB	Survey	TE-VSC	SMB
CP. 0	TOTEM	CMX	CSC RE	TK PIX	HCAL	EN Dept	RP

PX56 Plug
OPEN

TX54 Plug
OPEN

Saturday

22. December 2018

Crane

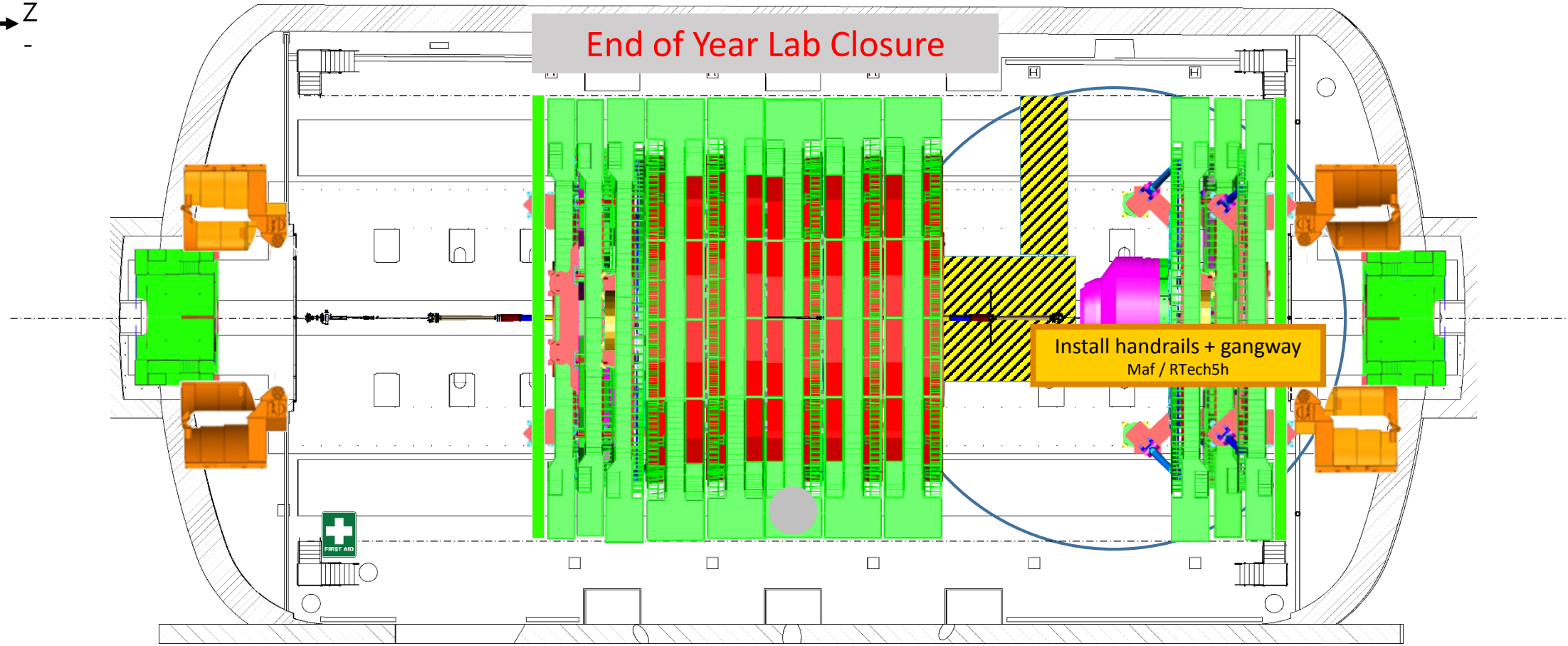
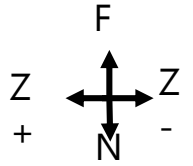

5m



Cryo.	EL power	Water cool.	Database				
IT	Magnet	C6F14	Gas				
SL. 0	GEM	ECAL	ZEC	DT+ RB	Survey	TE-VSC	SMB
CP. 0	TOTEM	CMX	CSC RE	TK PIX	HCAL	EN Dept	RP

PX56 Plug
OPEN

TX54 Plug
OPEN

Sunday

23. December 2018

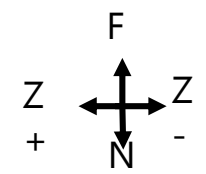

End of Year Lab Closure

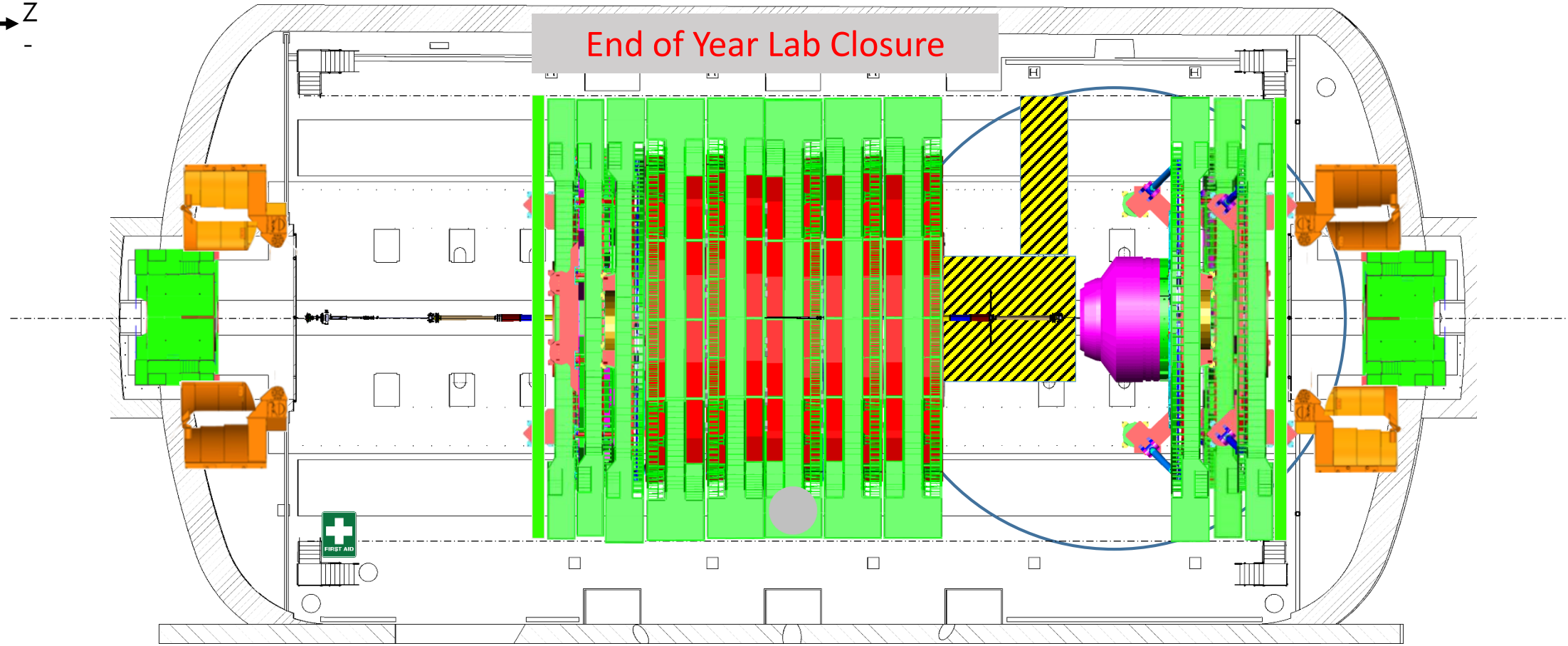

5m



Crane

Cryo.	EL power	Water cool.	Database				
IT	Magnet	C6F14	Gas				
SL. 0	GEM	ECAL	ZEC	DT+ RB	Survey	TE-VSC	SMB
CP. 0	TOTEM	CMX	CSC RE	TK PIX	HCAL	EN Dept	RP

PX56 Plug OPEN
TX54 Plug OPEN

Monday
24. December 2018



End of Year Lab Closure

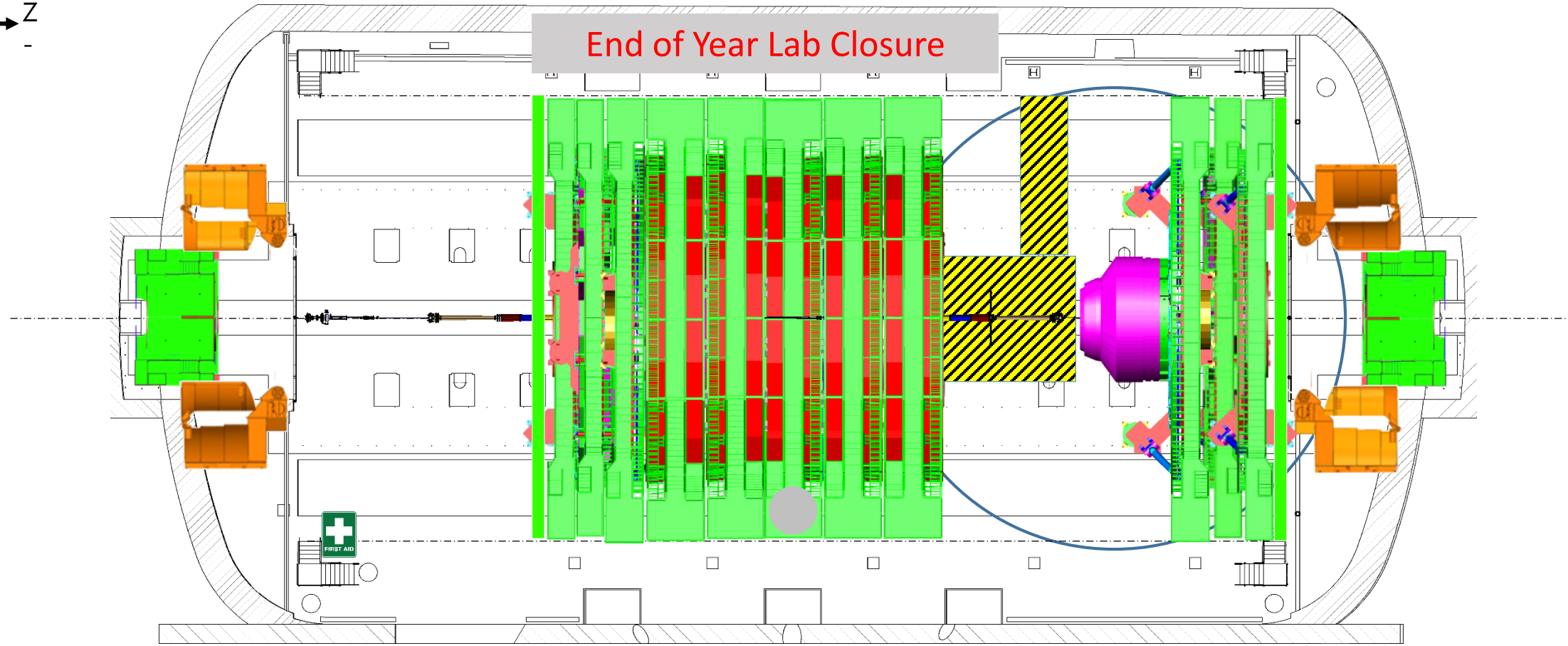

5m



Crane

Cryo.	EL power	Water cool.	Database				
IT	Magnet	C6F14	Gas				
SL. 0	GEM	ECAL	ZEC	DT+ RB	Survey	TE-VSC	SMB
CP. 0	TOTEM	CMX	CSC RE	TK PIX	HCAL	EN Dept	RP

PX56 Plug OPEN
TX54 Plug OPEN

Tuesday
25. December 2018

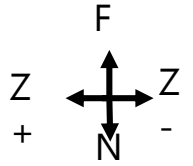

End of Year Lab Closure

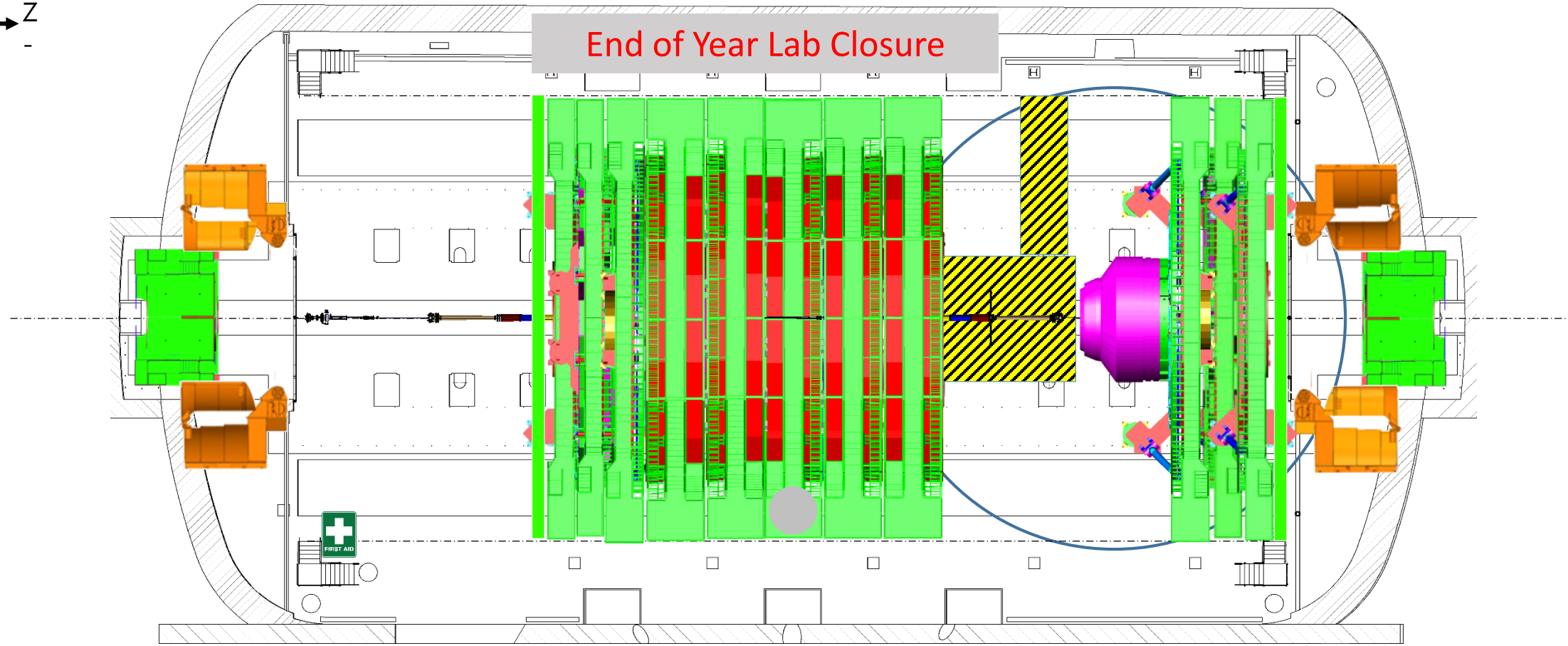

5m



Crane

Cryo.	EL power	Water cool.	Database				
IT	Magnet	C6F14	Gas				
SL. 0	GEM	ECAL	ZEC	DT+ RB	Survey	TE-VSC	SMB
CP. 0	TOTEM	CMX	CSC RE	TK PIX	HCAL	EN Dept	RP

PX56 Plug OPEN
TX54 Plug OPEN

Wednesday
26. December 2018

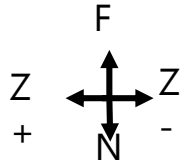

End of Year Lab Closure

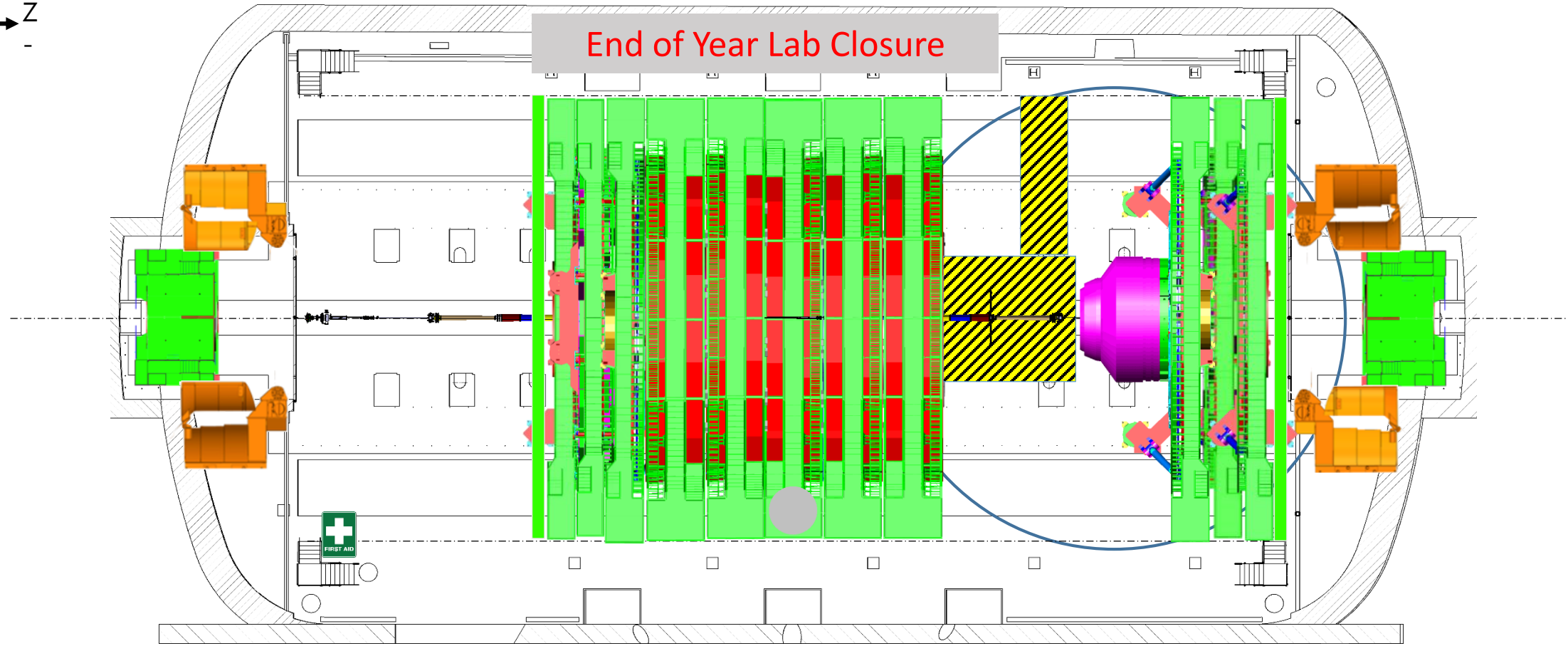

5m



Crane

Cryo.	EL power	Water cool.	Database				
IT	Magnet	C6F14	Gas				
SL. 0	GEM	ECAL	ZEC	DT+ RB	Survey	TE-VSC	SMB
CP. 0	TOTEM	CMX	CSC RE	TK PIX	HCAL	EN Dept	RP

PX56 Plug OPEN
TX54 Plug OPEN

Thursday
27. December 2018

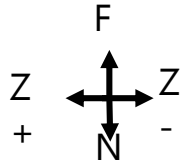

End of Year Lab Closure

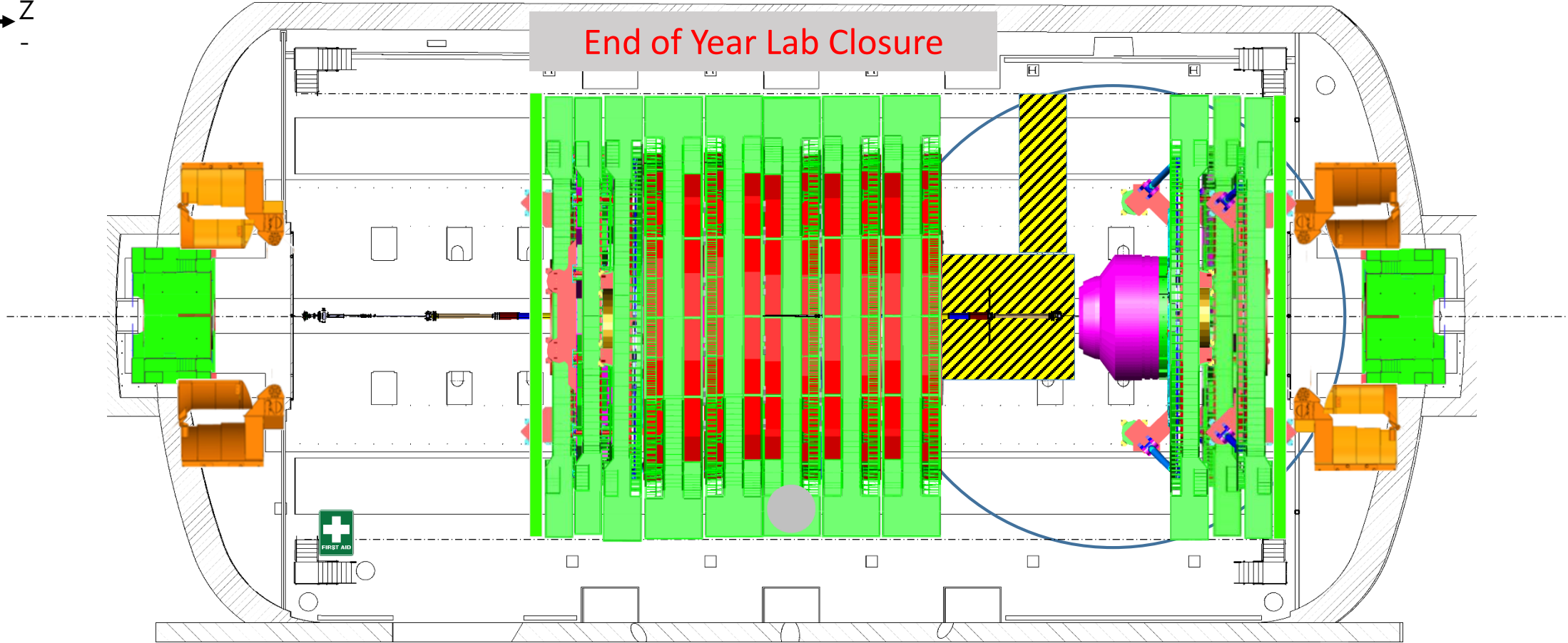

5m



Crane

Cryo.	EL power	Water cool.	Database				
IT	Magnet	C6F14	Gas				
SL. 0	GEM	ECAL	ZEC	DT+ RB	Survey	TE-VSC	SMB
CP. 0	TOTEM	CMX	CSC RE	TK PIX	HCAL	EN Dept	RP

PX56 Plug OPEN
TX54 Plug OPEN

Friday
28. December 2018

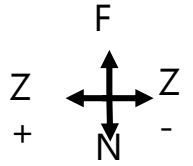

End of Year Lab Closure

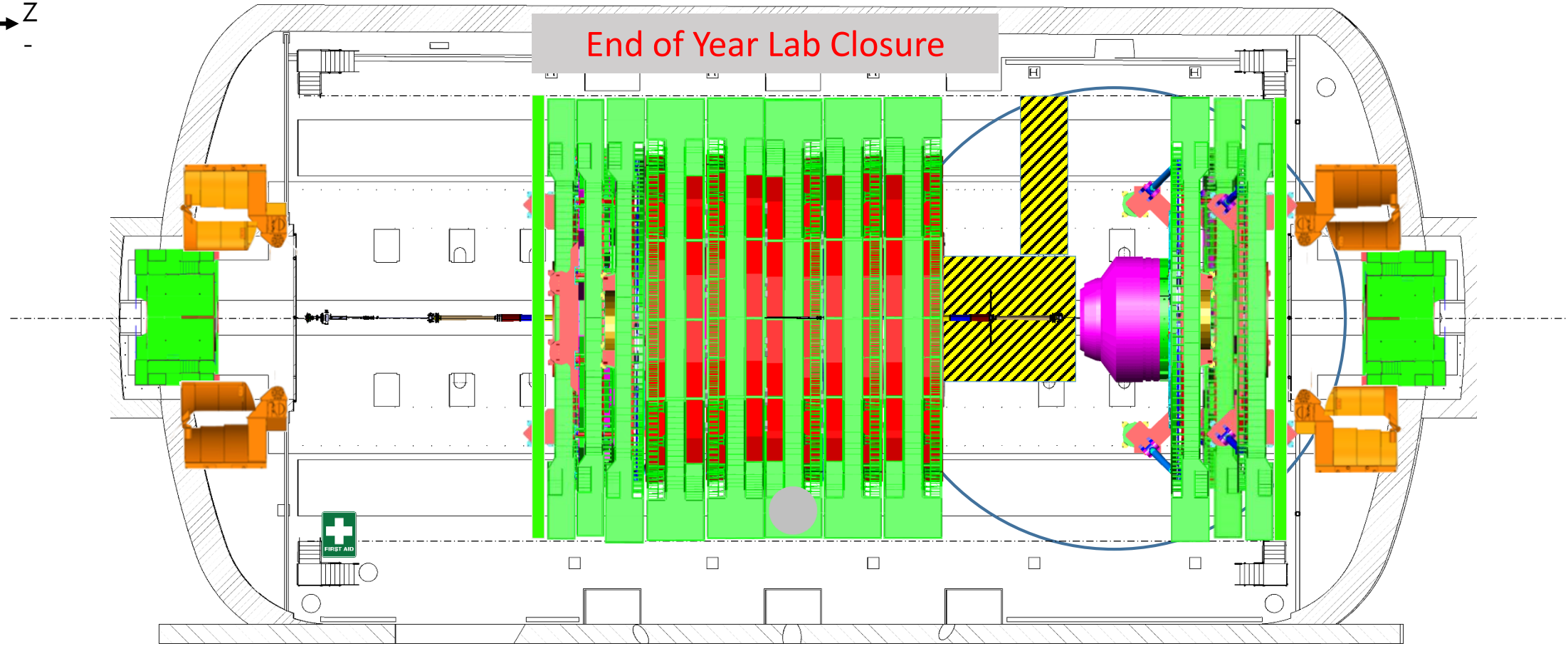

5m



Crane

Cryo.	EL power	Water cool.	Database				
IT	Magnet	C6F14	Gas				
SL. 0	GEM	ECAL	ZEC	DT+ RB	Survey	TE-VSC	SMB
CP. 0	TOTEM	CMX	CSC RE	TK PIX	HCAL	EN Dept	RP

PX56 Plug OPEN
TX54 Plug OPEN

Saturday
29. December 2018

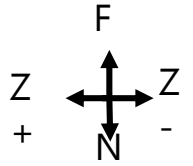

End of Year Lab Closure

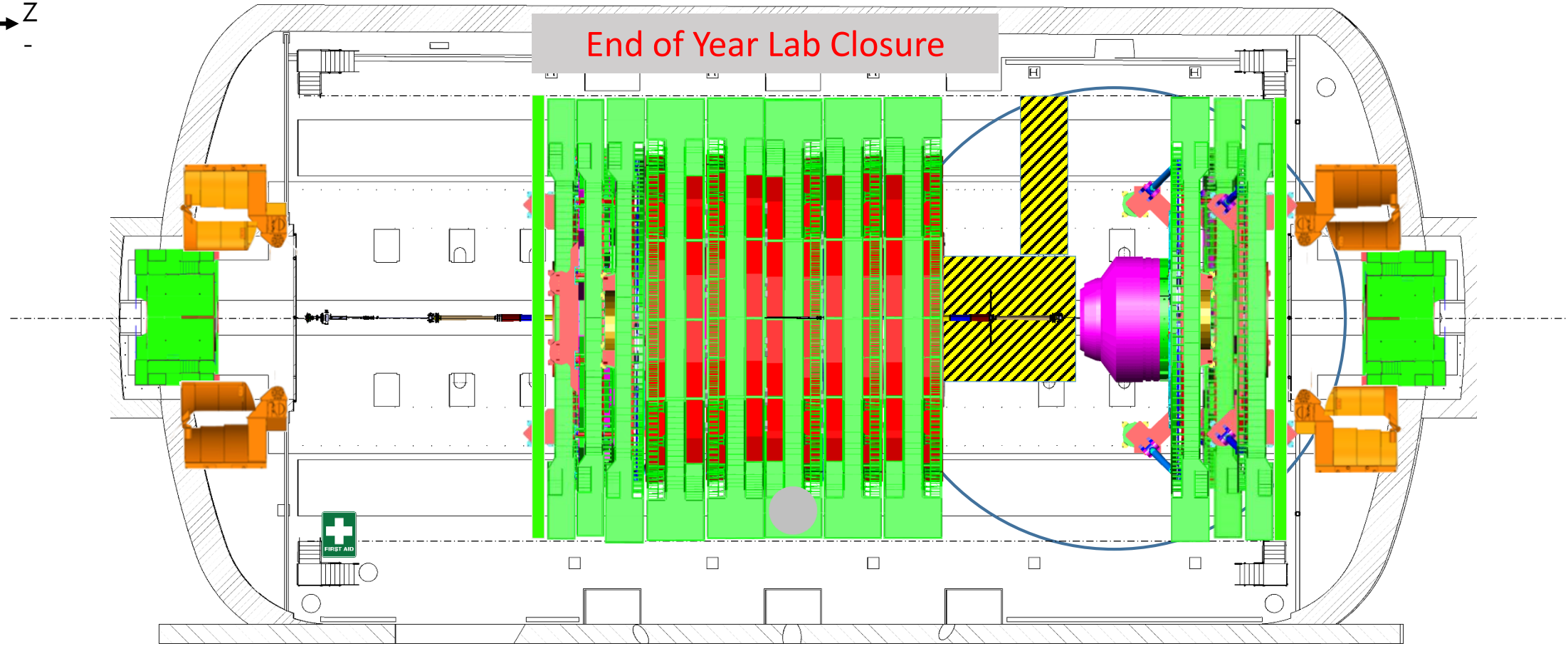

5m



Crane

Cryo.	EL power	Water cool.	Database				
IT	Magnet	C6F14	Gas				
SL. 0	GEM	ECAL	ZEC	DT+ RB	Survey	TE-VSC	SMB
CP. 0	TOTEM	CMX	CSC RE	TK PIX	HCAL	EN Dept	RP

PX56 Plug OPEN
TX54 Plug OPEN

Sunday
30. December 2018

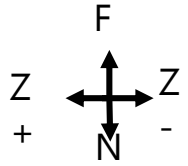

End of Year Lab Closure

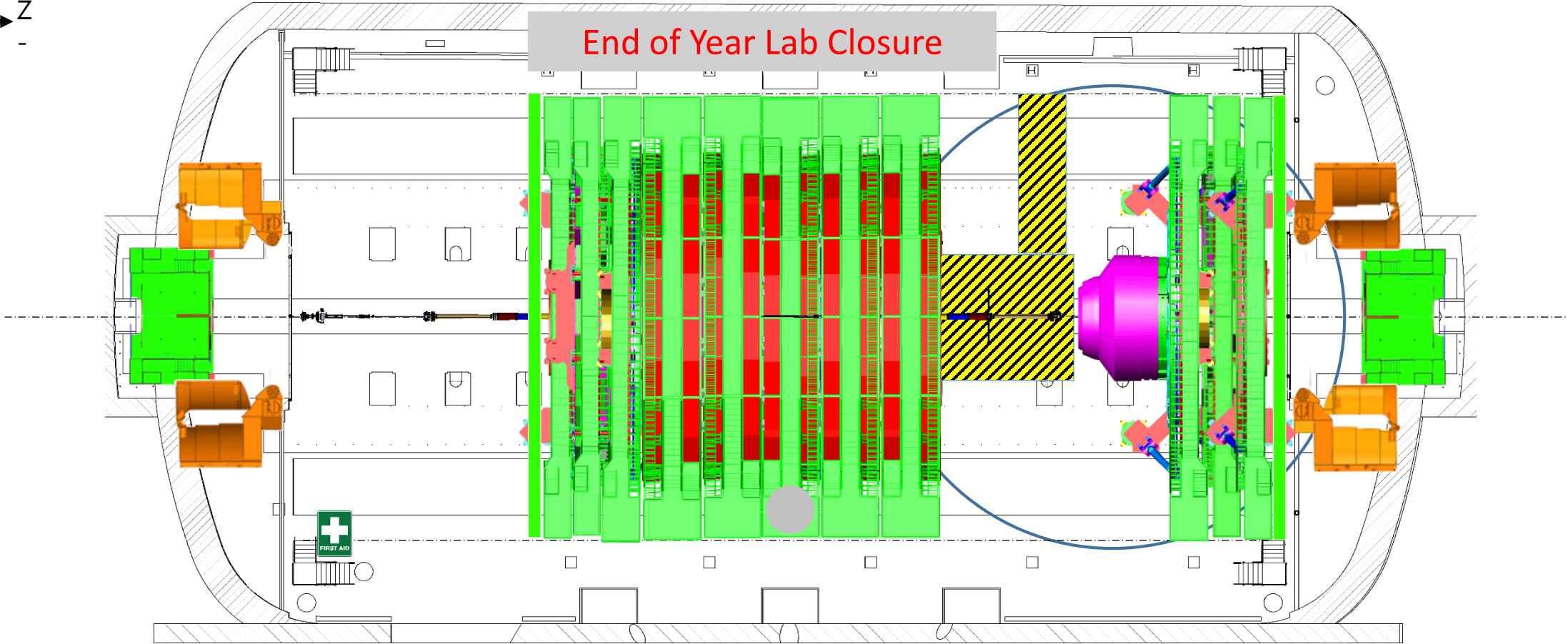

5m



Crane

Cryo.	EL power	Water cool.	Database				
IT	Magnet	C6F14	Gas				
SL. 0	GEM	ECAL	ZEC	DT+ RB	Survey	TE-VSC	SMB
CP. 0	TOTEM	CMX	CSC RE	TK PIX	HCAL	EN Dept	RP

PX56 Plug OPEN
TX54 Plug OPEN

Monday
31. December 2018

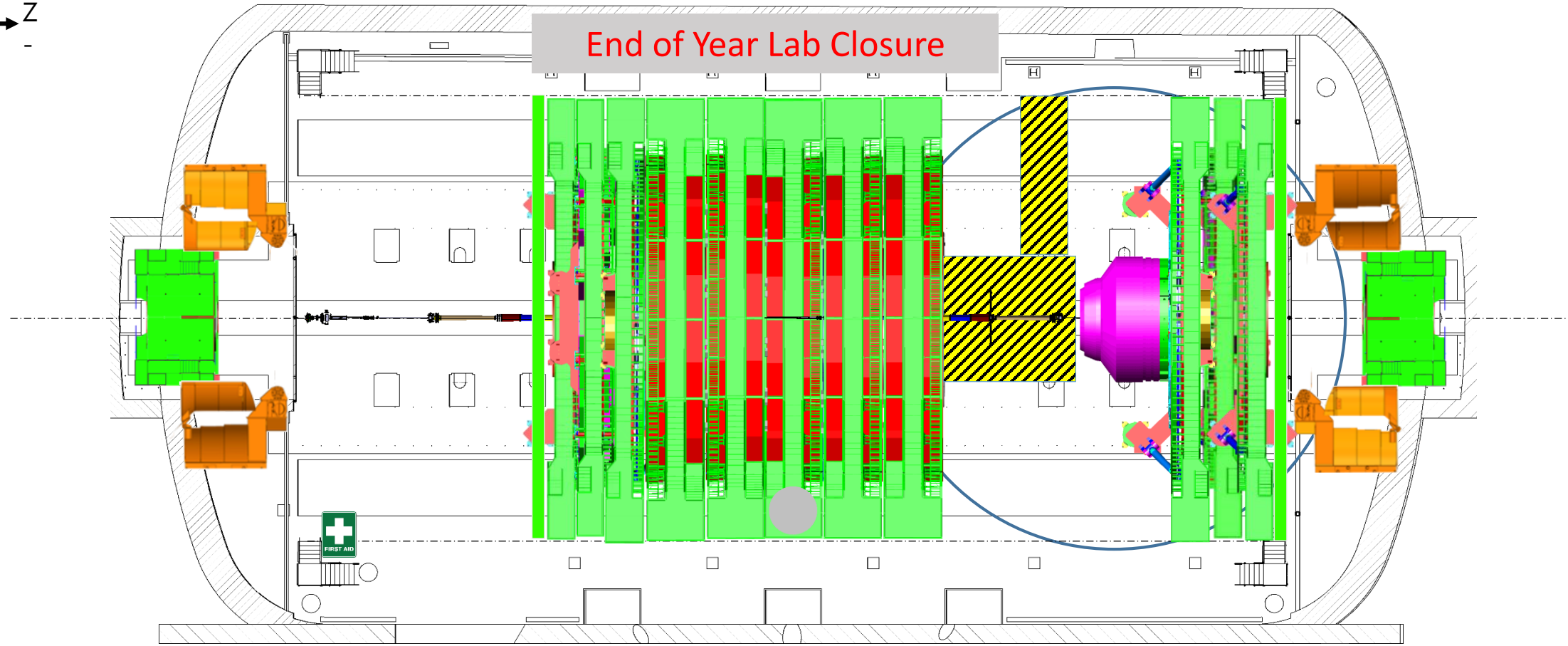
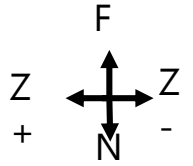

5m



Crane

Cryo.	EL power	Water cool.	Database				
IT	Magnet	C6F14	Gas				
SL. 0	GEM	ECAL	ZEC	DT+ RB	Survey	TE-VSC	SMB
CP. 0	TOTEM	CMX	CSC RE	TK PIX	HCAL	EN Dept	RP

PX56 Plug OPEN
TX54 Plug OPEN

Tuesday
01. January 2019

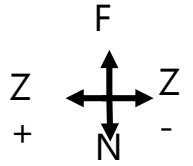

End of Year Lab Closure

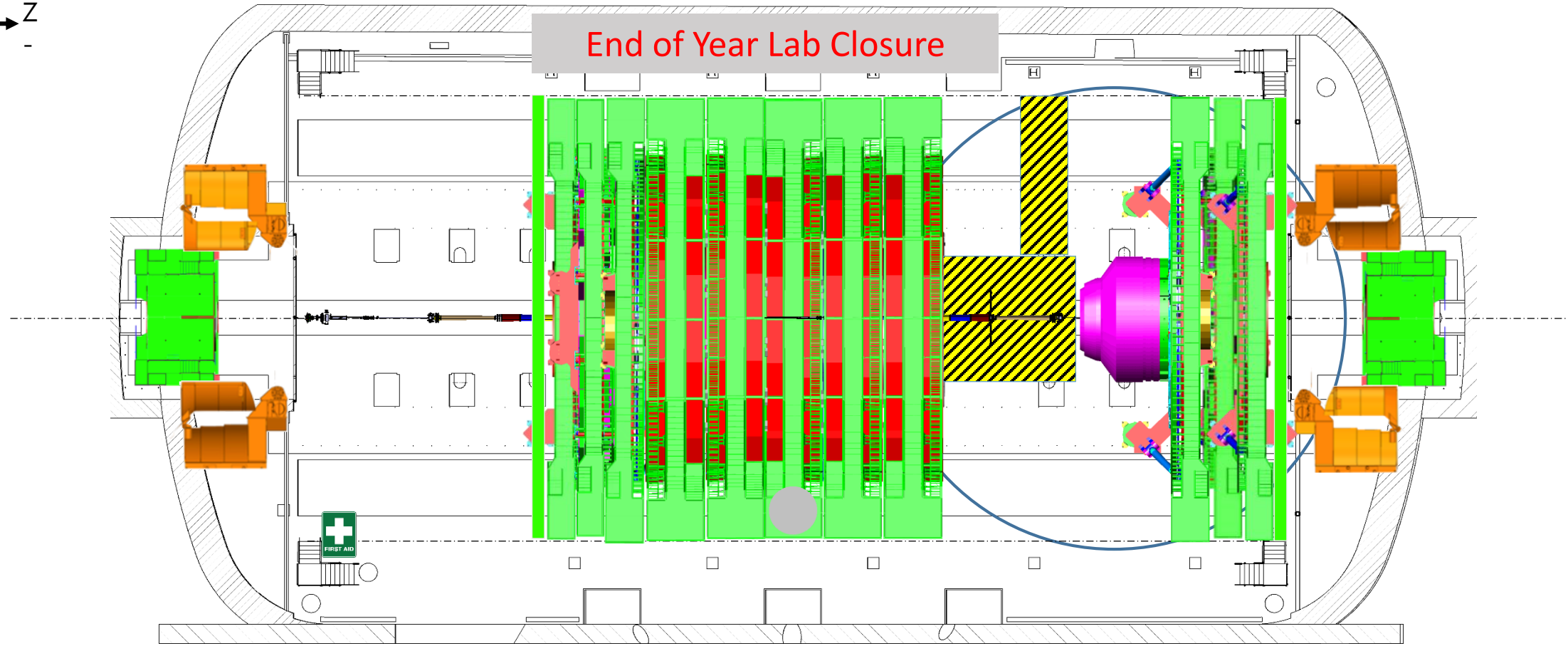

5m



Crane

Cryo.	EL power	Water cool.	Database				
IT	Magnet	C6F14	Gas				
SL. 0	GEM	ECAL	ZEC	DT+ RB	Survey	TE-VSC	SMB
CP. 0	TOTEM	CMX	CSC RE	TK PIX	HCAL	EN Dept	RP

PX56 Plug OPEN
TX54 Plug OPEN

Wednesday
02. January 2019

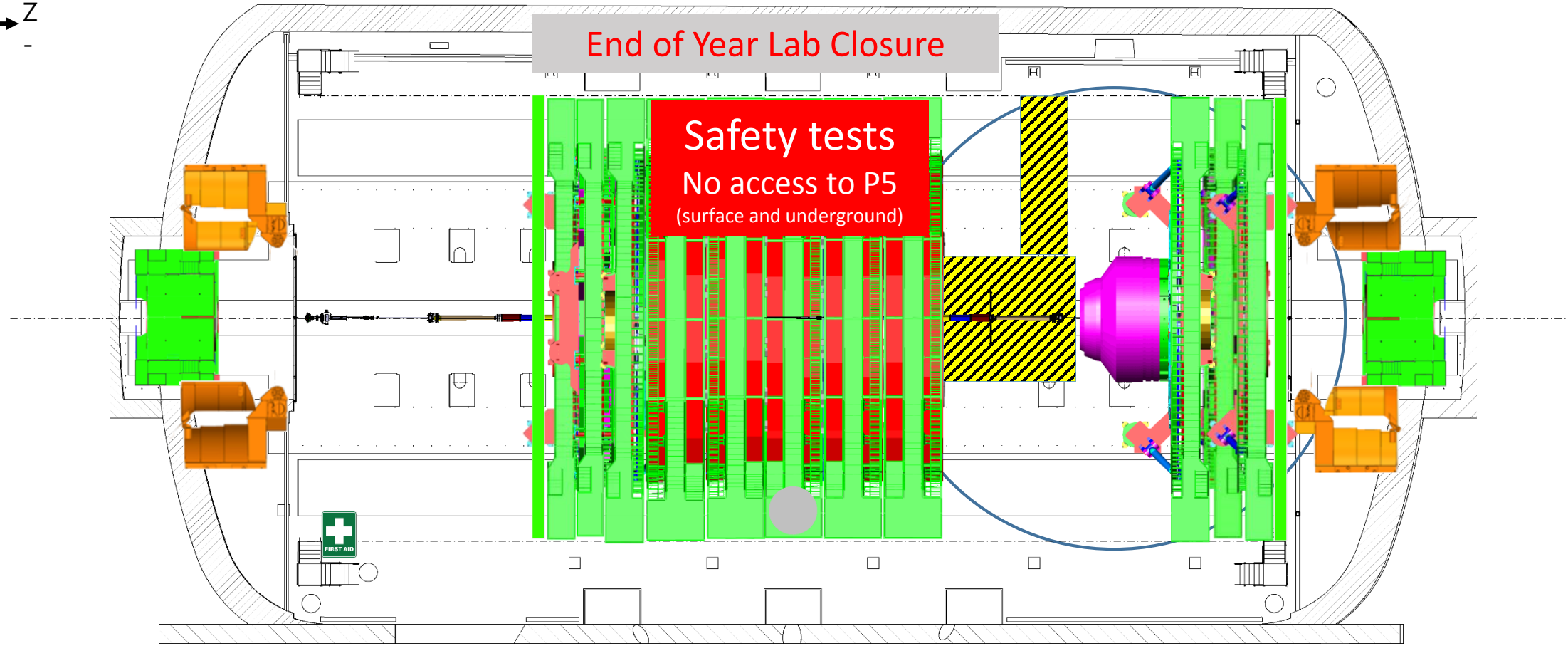
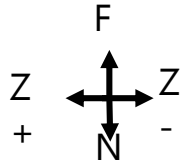

5m



Crane

Cryo.	EL power	Water cool.	Database				
IT	Magnet	C6F14	Gas				
SL. 0	GEM	ECAL	ZEC	DT+ RB	Survey	TE-VSC	SMB
CP. 0	TOTEM	CMX	CSC RE	TK PIX	HCAL	EN Dept	RP

PX56 Plug OPEN
TX54 Plug OPEN

Thursday
03. January 2019

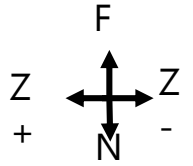

End of Year Lab Closure

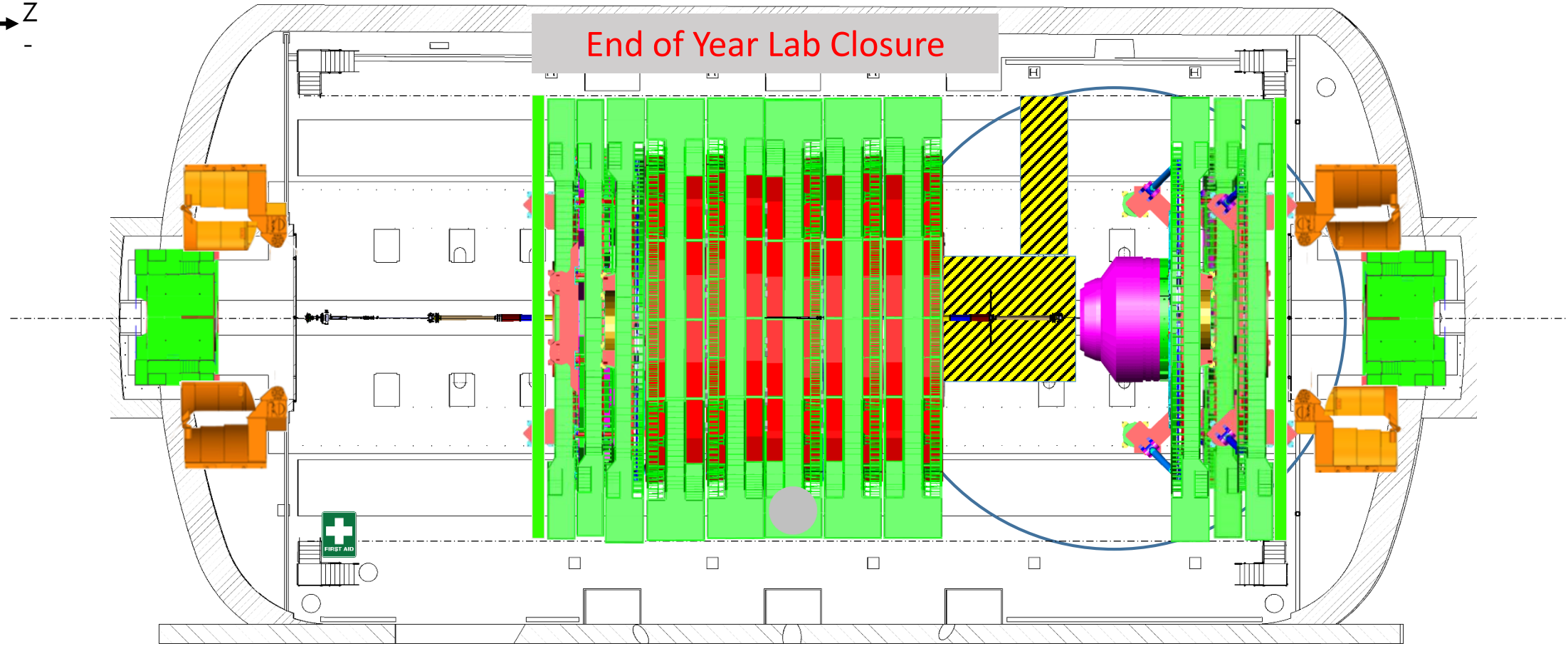

5m



Crane

Cryo.	EL power	Water cool.	Database				
IT	Magnet	C6F14	Gas				
SL. 0	GEM	ECAL	ZEC	DT+ RB	Survey	TE-VSC	SMB
CP. 0	TOTEM	CMX	CSC RE	TK PIX	HCAL	EN Dept	RP

PX56 Plug OPEN
TX54 Plug OPEN

Friday
04. January 2019

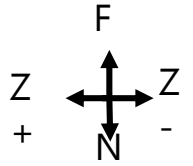

End of Year Lab Closure

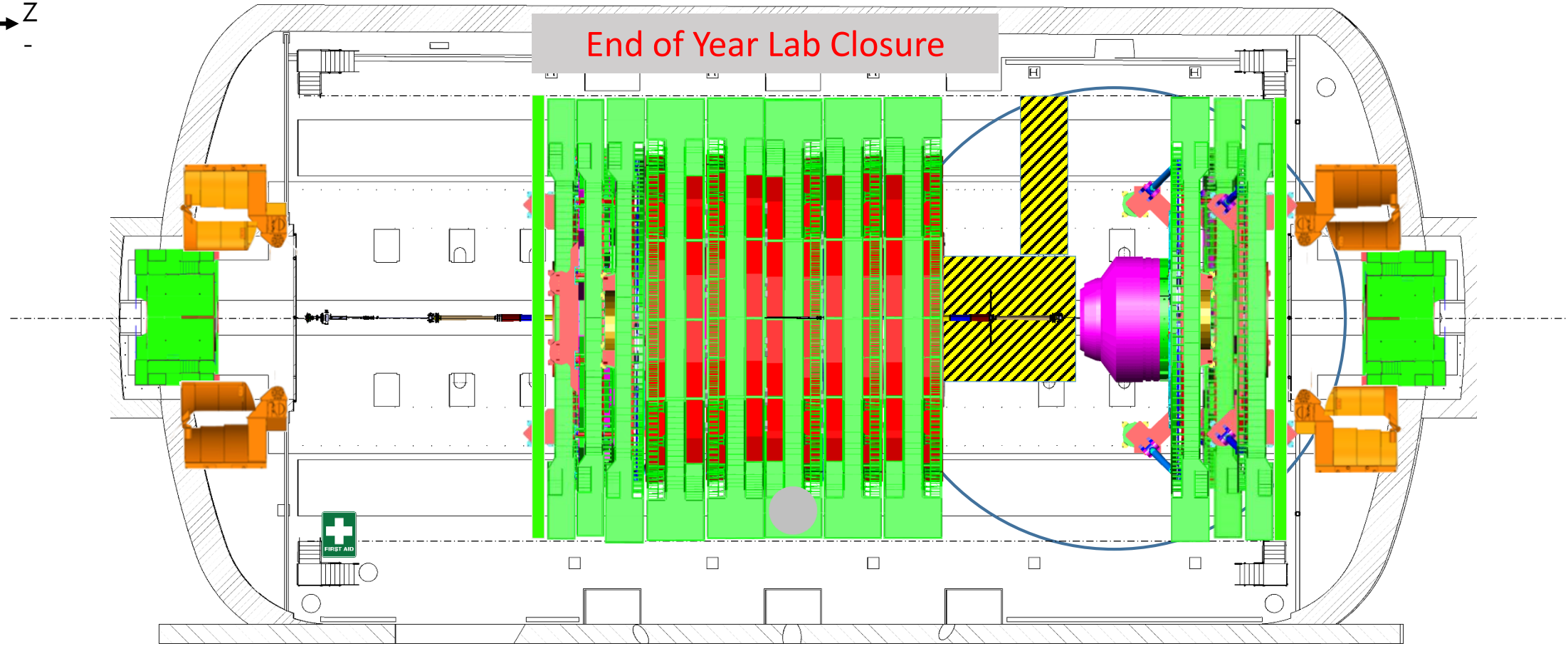

5m



Crane

Cryo.	EL power	Water cool.	Database				
IT	Magnet	C6F14	Gas				
SL. 0	GEM	ECAL	ZEC	DT+ RB	Survey	TE-VSC	SMB
CP. 0	TOTEM	CMX	CSC RE	TK PIX	HCAL	EN Dept	RP

PX56 Plug OPEN
TX54 Plug OPEN

Saturday
05. January 2019



End of Year Lab Closure

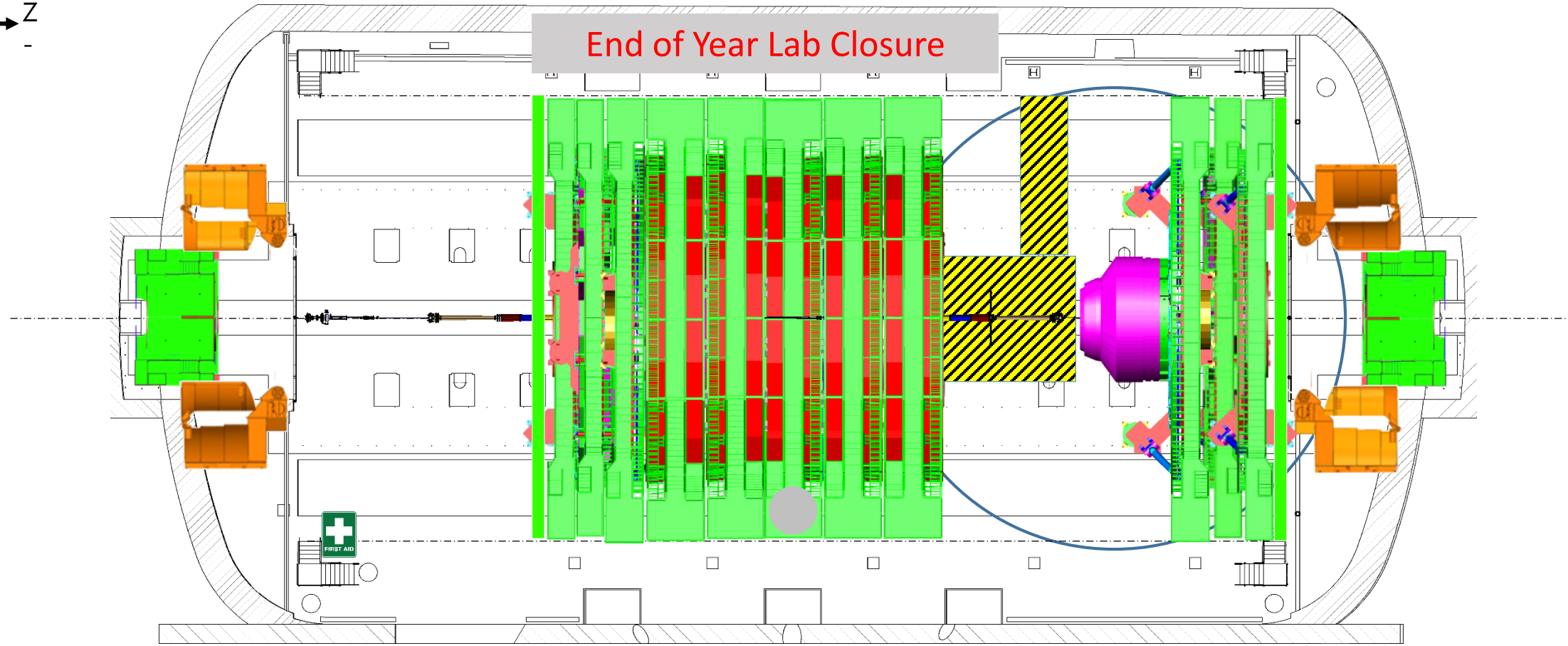

5m



Crane

Cryo.	EL power	Water cool.	Database				
IT	Magnet	C6F14	Gas				
SL. 0	GEM	ECAL	ZEC	DT+ RB	Survey	TE-VSC	SMB
CP. 0	TOTEM	CMX	CSC RE	TK PIX	HCAL	EN Dept	RP

PX56 Plug OPEN
TX54 Plug OPEN

Sunday
06. January 2019

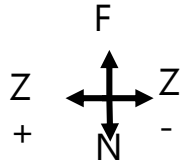

End of Year Lab Closure

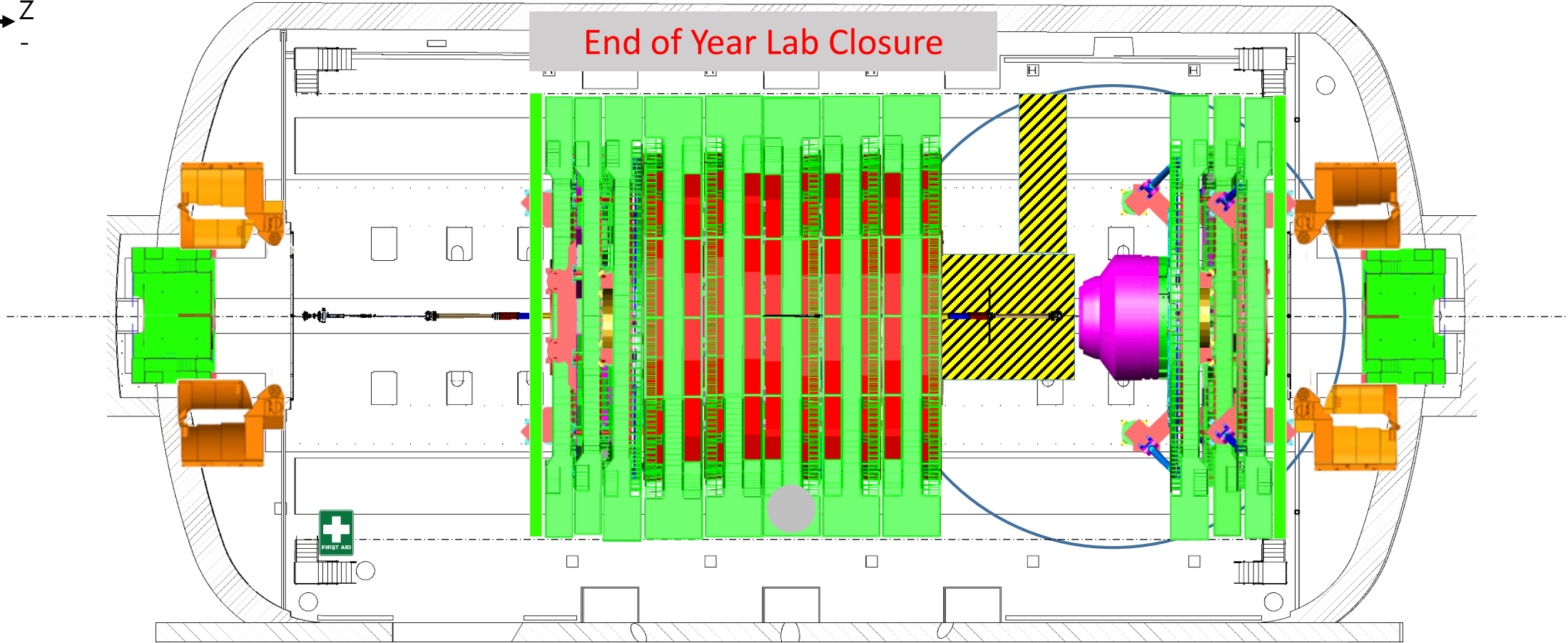

5m



Crane

Cryo.	■	EL power	■	Water cool.	■	Database	■							
IT	■	Magnet	■	C6F14	■	Gas	■							
SL.	0	GEM	■	ZEC	■	DT+ RB	■	Survey	■	TE-VSC	■	SMB	■	
CP.	0	TOTEM	■	CMX	■	CSC RE	■	TK PIX	■	HCAL	■	EN Dept	■	RP

PX56 Plug OPEN
TX54 Plug OPEN

Monday
07. January 2019

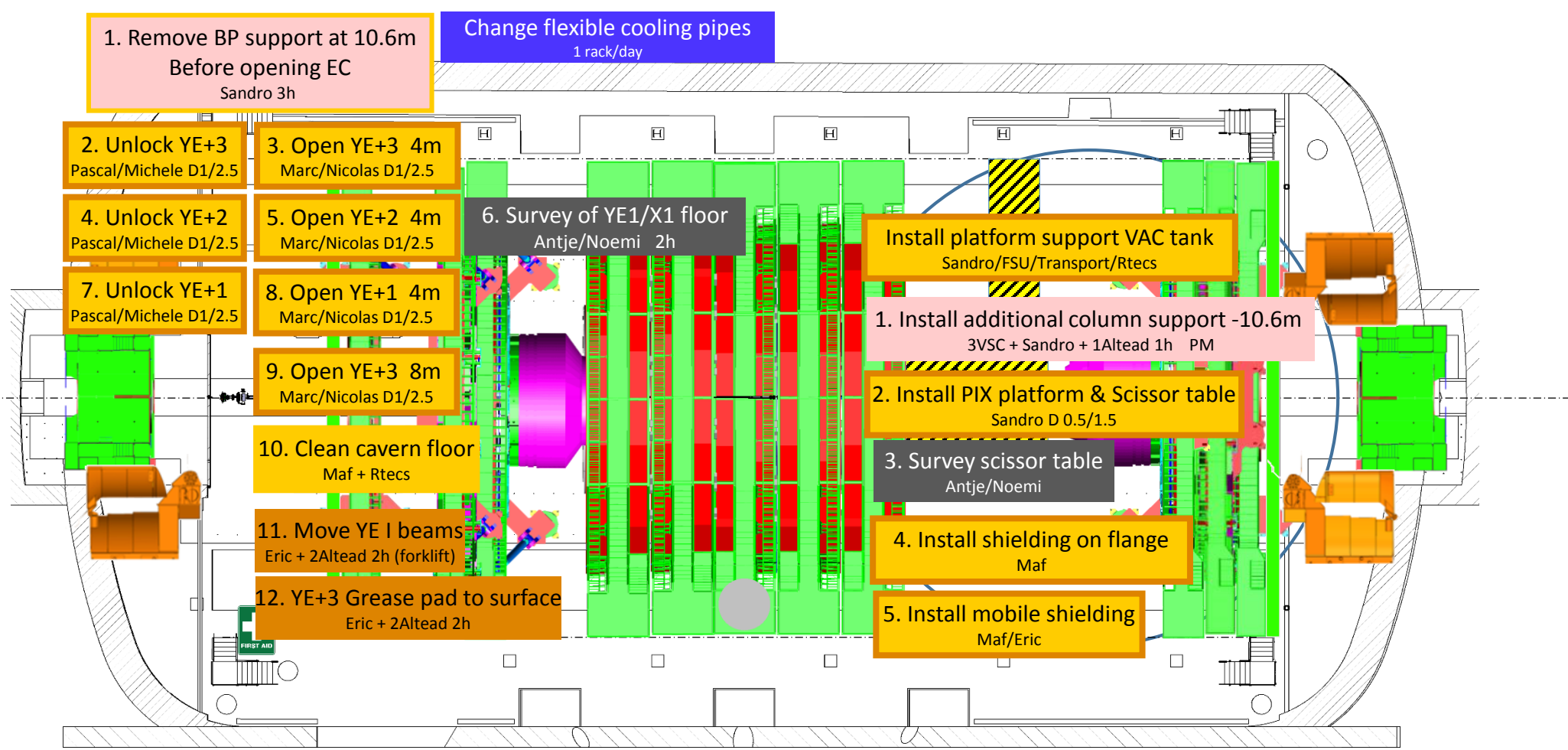
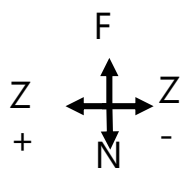

1. Remove BP support at 10.6m
Before opening EC
Sandro 3h

Change flexible cooling pipes
1 rack/day

2. Unlock YE+3
Pascal/Michele D1/2.5

3. Open YE+3 4m
Marc/Nicolas D1/2.5

4. Unlock YE+2
Pascal/Michele D1/2.5

5. Open YE+2 4m
Marc/Nicolas D1/2.5

6. Survey of YE1/X1 floor
Antje/Noemi 2h

Install platform support VAC tank
Sandro/FSU/Transport/Rtecs

7. Unlock YE+1
Pascal/Michele D1/2.5

8. Open YE+1 4m
Marc/Nicolas D1/2.5

1. Install additional column support -10.6m
3VSC + Sandro + 1Altead 1h PM

9. Open YE+3 8m
Marc/Nicolas D1/2.5

2. Install PIX platform & Scissor table
Sandro D 0.5/1.5

10. Clean cavern floor
Maf + Rtecs

3. Survey scissor table
Antje/Noemi

11. Move YE I beams
Eric + 2Altead 2h (forklift)

4. Install shielding on flange
Maf

12. YE+3 Grease pad to surface
Eric + 2Altead 2h

5. Install mobile shielding
Maf/Eric

5m



Crane

Cryo.	EL power	Water cool.	Database				
IT	Magnet	C6F14	Gas				
SL. 0	GEM	ECAL	ZEC	DT+ RB	Survey	TE-VSC	SMB
CP. 0	TOTEM	CMX	CSC RE	TK PIX	HCAL	EN Dept	RP

PX56 Plug OPEN
TX54 Plug OPEN

Tuesday

08. January 2019

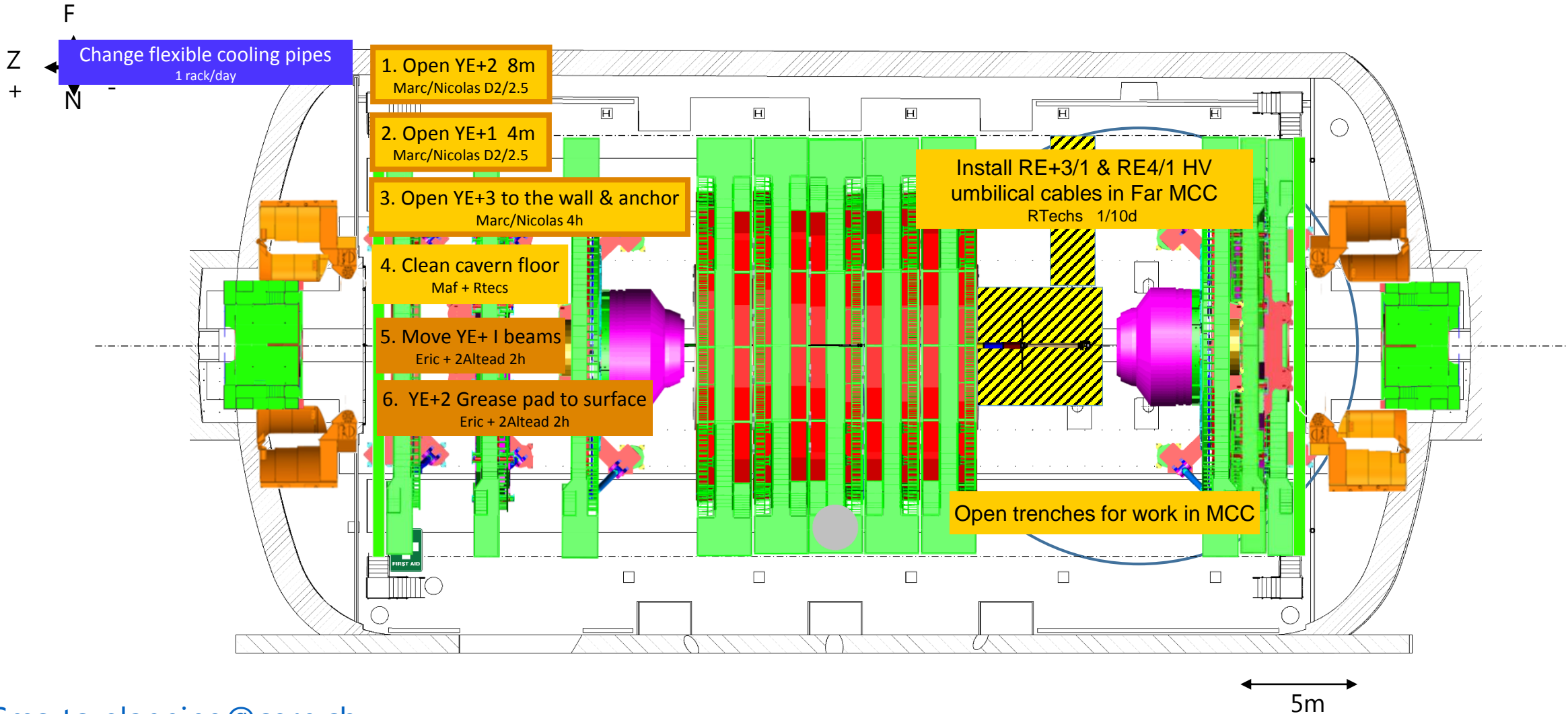



Crane

Cryo.	EL power	Water cool.	Database				
IT	Magnet	C6F14	Gas				
SL. 0	GEM	ECAL	ZEC	DT+ RB	Survey	TE-VSC	SMB
CP. 0	TOTEM	CMX	CSC RE	TK PIX	HCAL	EN Dept	RP

PX56 Plug OPEN
TX54 Plug OPEN

Wednesday
09. January 2019

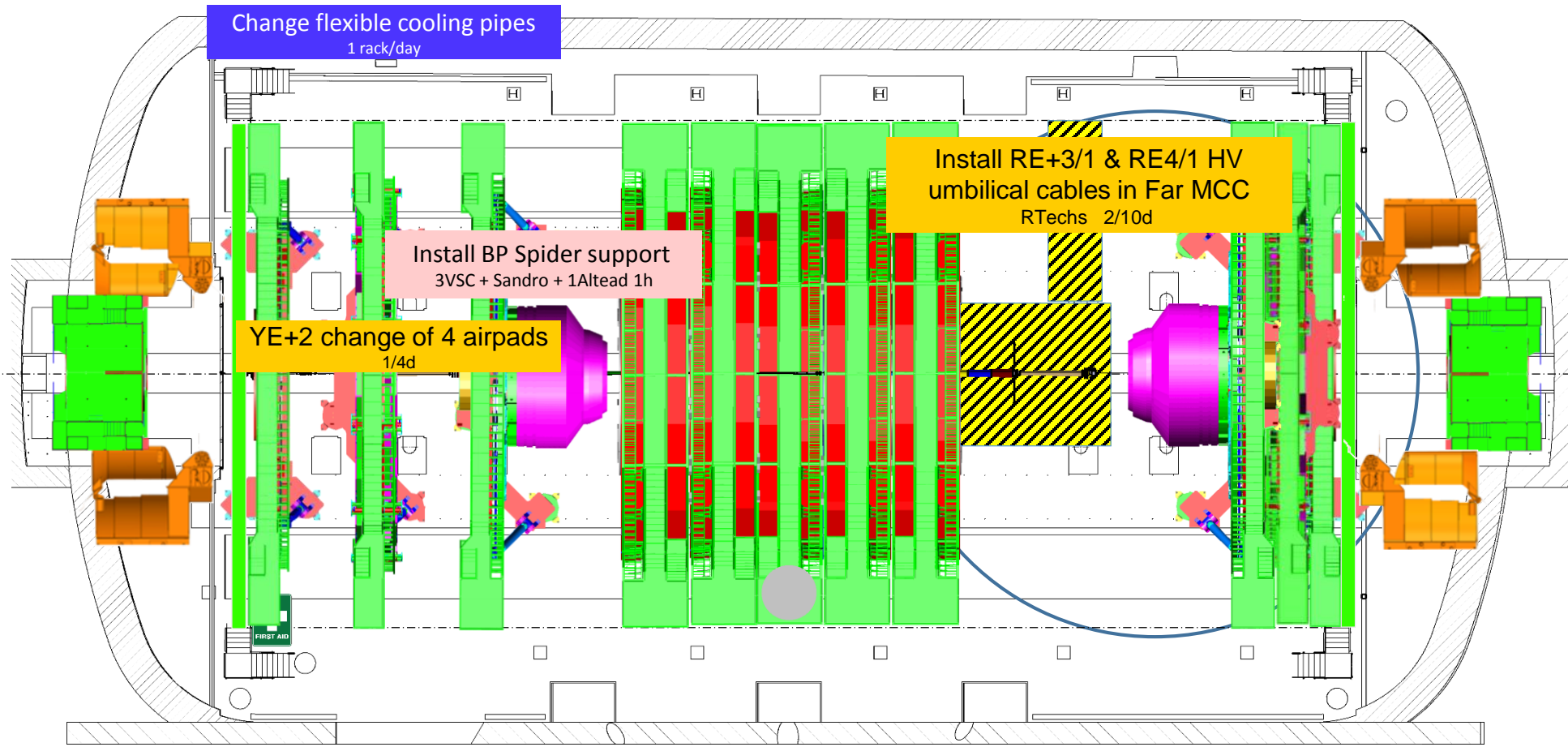
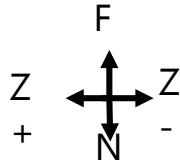

5m



Crane

Cryo.	EL power	Water cool.	Database				
IT	Magnet	C6F14	Gas				
SL. 0	GEM	ECAL	ZEC	DT+ RB	Survey	TE-VSC	SMB
CP. 0	TOTEM	CMX	CSC RE	TK PIX	HCAL	EN Dept	RP

PX56 Plug OPEN
TX54 Plug OPEN

Thursday
10. January 2019

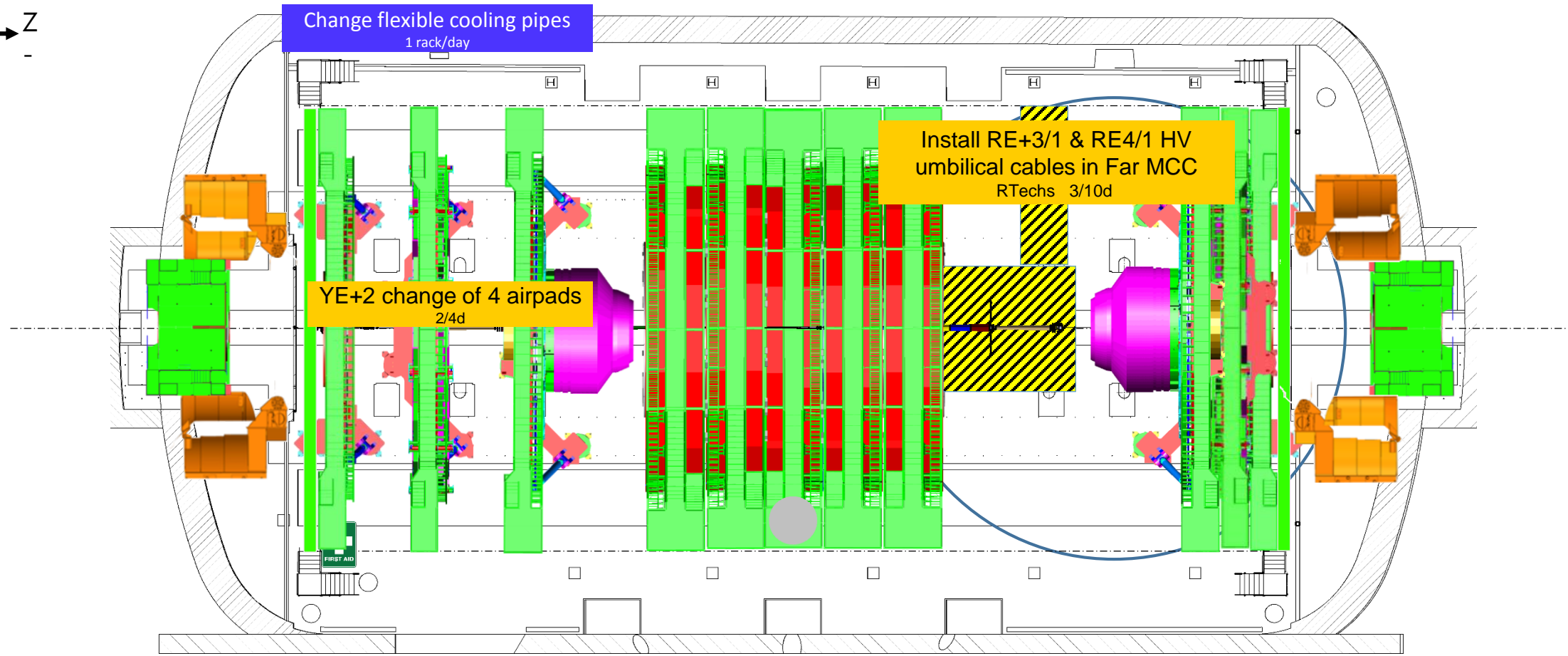

5m



Crane

Cryo.	EL power	Water cool.	Database				
IT	Magnet	C6F14	Gas				
SL. 0	GEM	ECAL	ZEC	DT+ RB	Survey	TE-VSC	SMB
CP. 0	TOTEM	CMX	CSC RE	TK PIX	HCAL	EN Dept	RP

PX56 Plug OPEN
TX54 Plug OPEN

Friday
11. January 2019

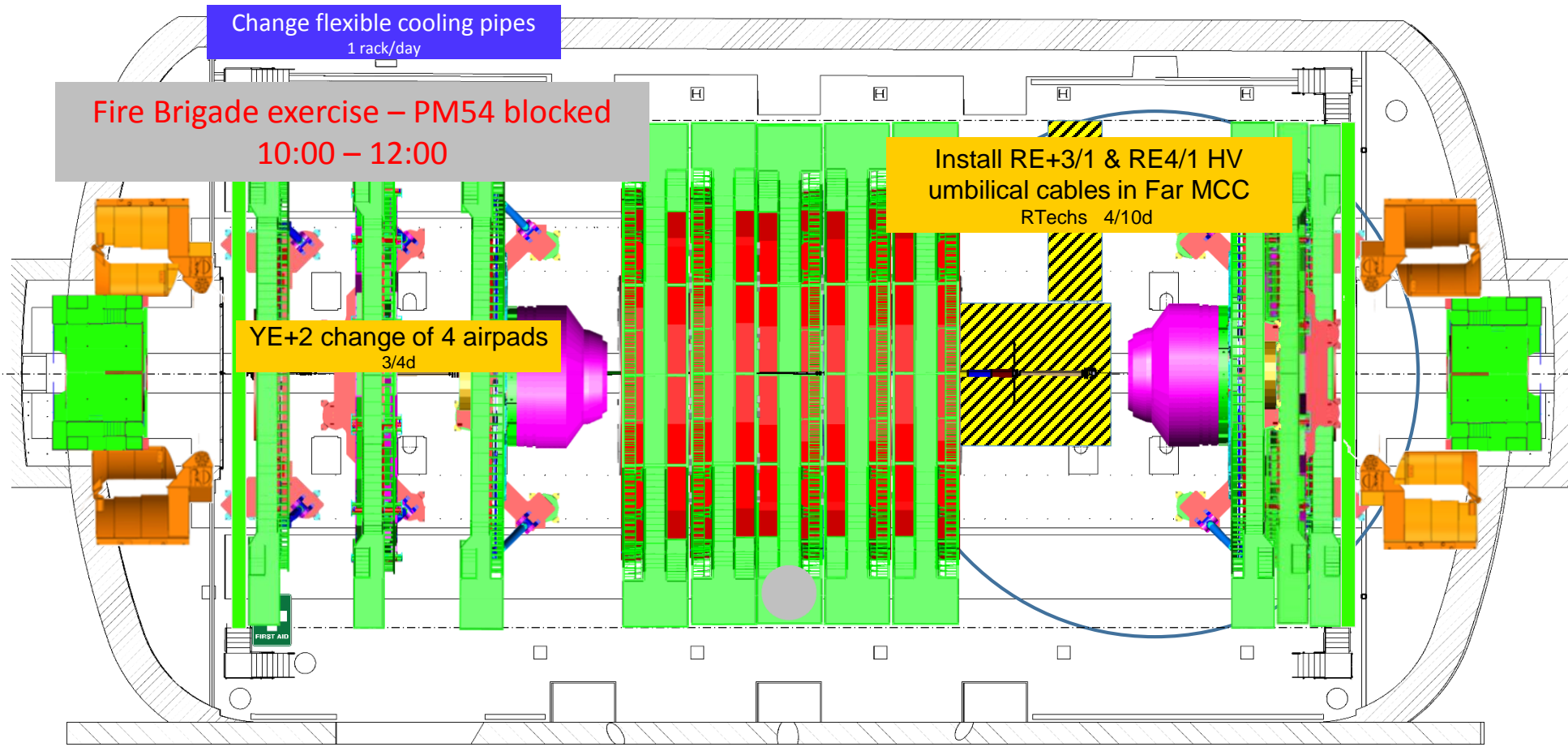
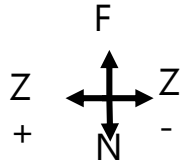

5m



Crane

Cryo.	EL power	Water cool.	Database				
IT	Magnet	C6F14	Gas				
SL. 0	GEM	ECAL	ZEC	DT+ RB	Survey	TE-VSC	SMB
CP. 0	TOTEM	CMX	CSC RE	TK PIX	HCAL	EN Dept	RP

PX56 Plug OPEN
TX54 Plug OPEN

Saturday
12. January 2019

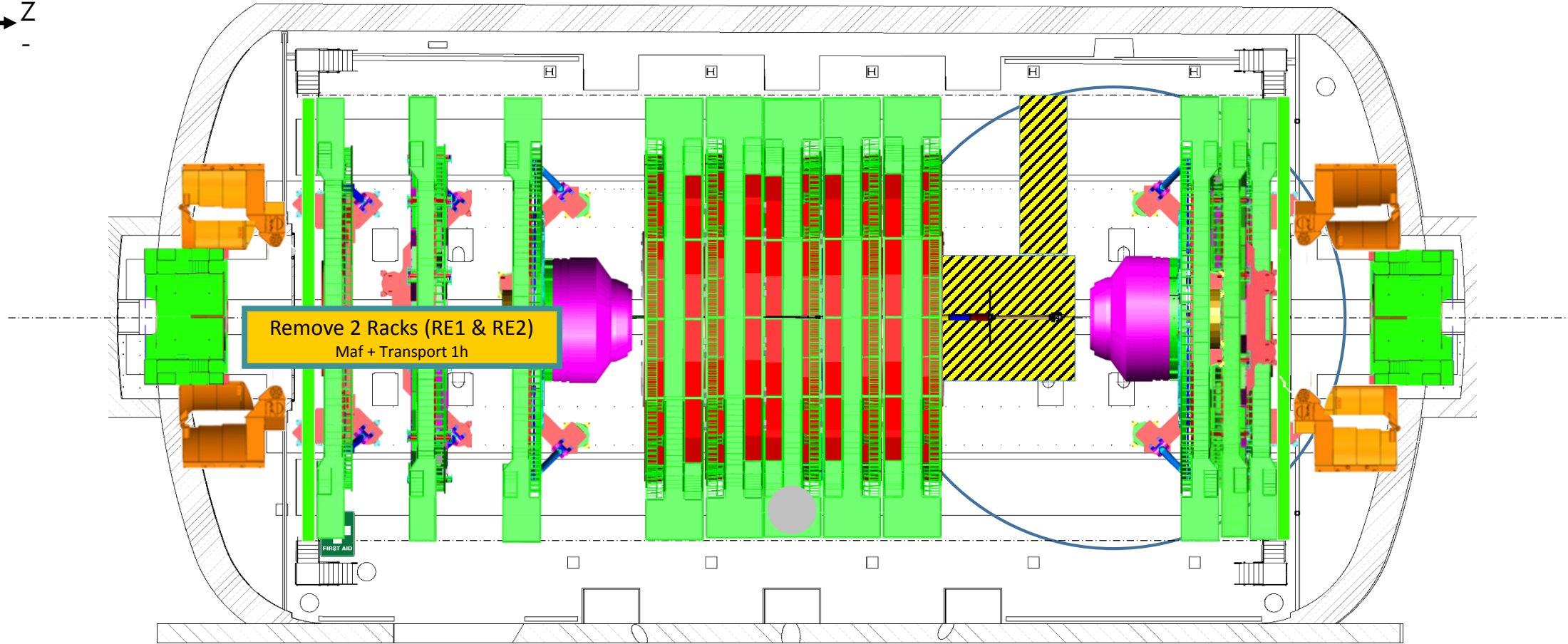
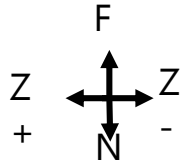

5m



Crane

Cryo.	EL power	Water cool.	Database				
IT	Magnet	C6F14	Gas				
SL. 0	GEM	ECAL	ZEC	DT+ RB	Survey	TE-VSC	SMB
CP. 0	TOTEM	CMX	CSC RE	TK PIX	HCAL	EN Dept	RP

PX56 Plug
OPEN

TX54 Plug
OPEN

Sunday

13. January 2019

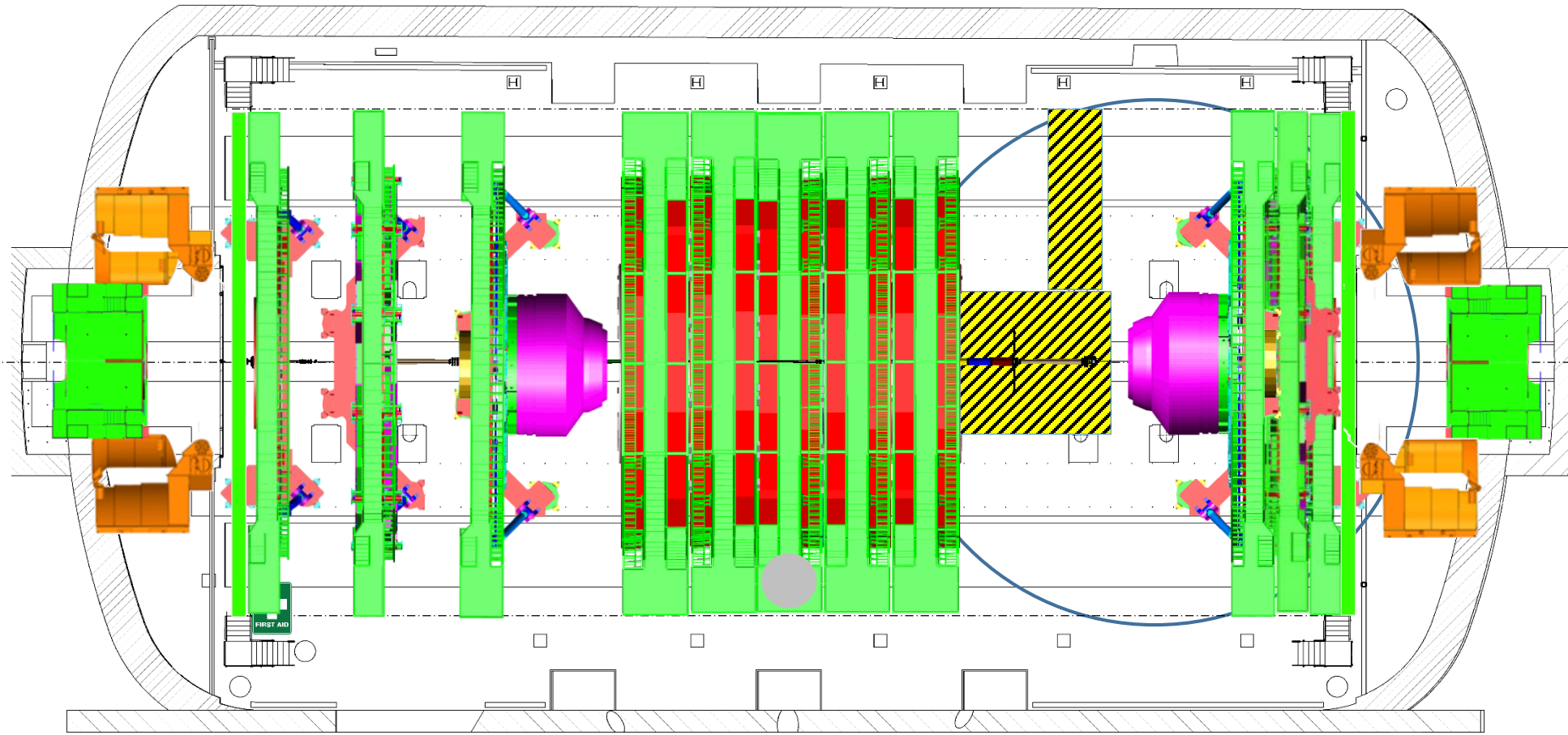
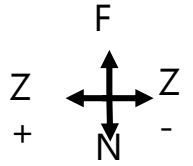

5m



Crane

Cryo.	EL power	Water cool.	Database				
IT	Magnet	C6F14	Gas				
SL. 0	GEM	ECAL	ZEC	DT+ RB	Survey	TE-VSC	SMB
CP. 0	TOTEM	CMX	CSC RE	TK PIX	HCAL	EN Dept	RP

PX56 Plug OPEN

Monday

TX54 Plug OPEN

14. January 2019

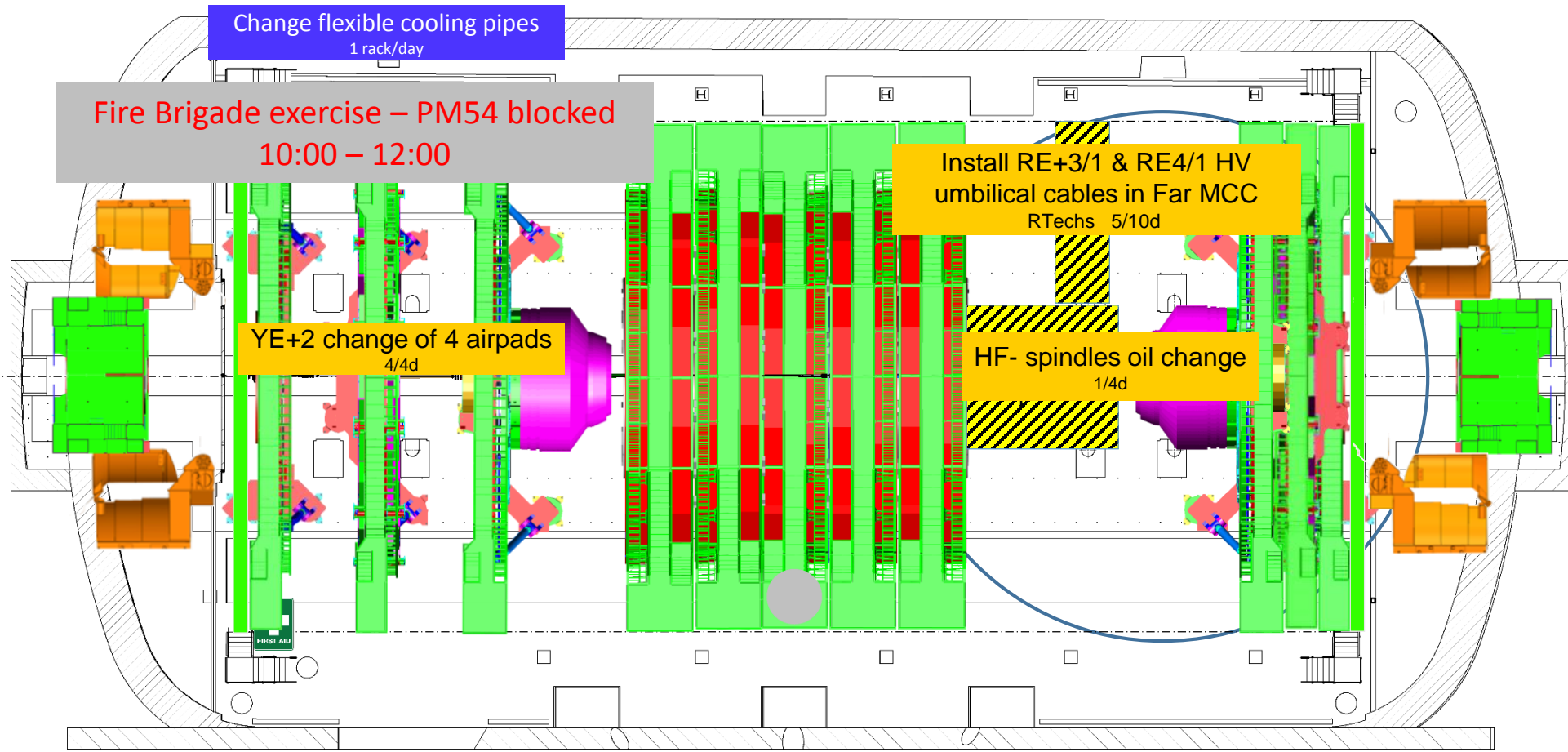
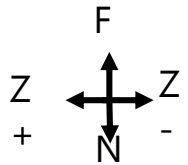

5m



Crane

Cryo.	EL power	Water cool.	Database				
IT	Magnet	C6F14	Gas				
SL. 0	GEM	ECAL	ZEC	DT+ RB	Survey	TE-VSC	SMB
CP. 0	TOTEM	CMX	CSC RE	TK PIX	HCAL	EN Dept	RP

PX56 Plug
OPEN

TX54 Plug
OPEN

Tuesday

15. January 2019

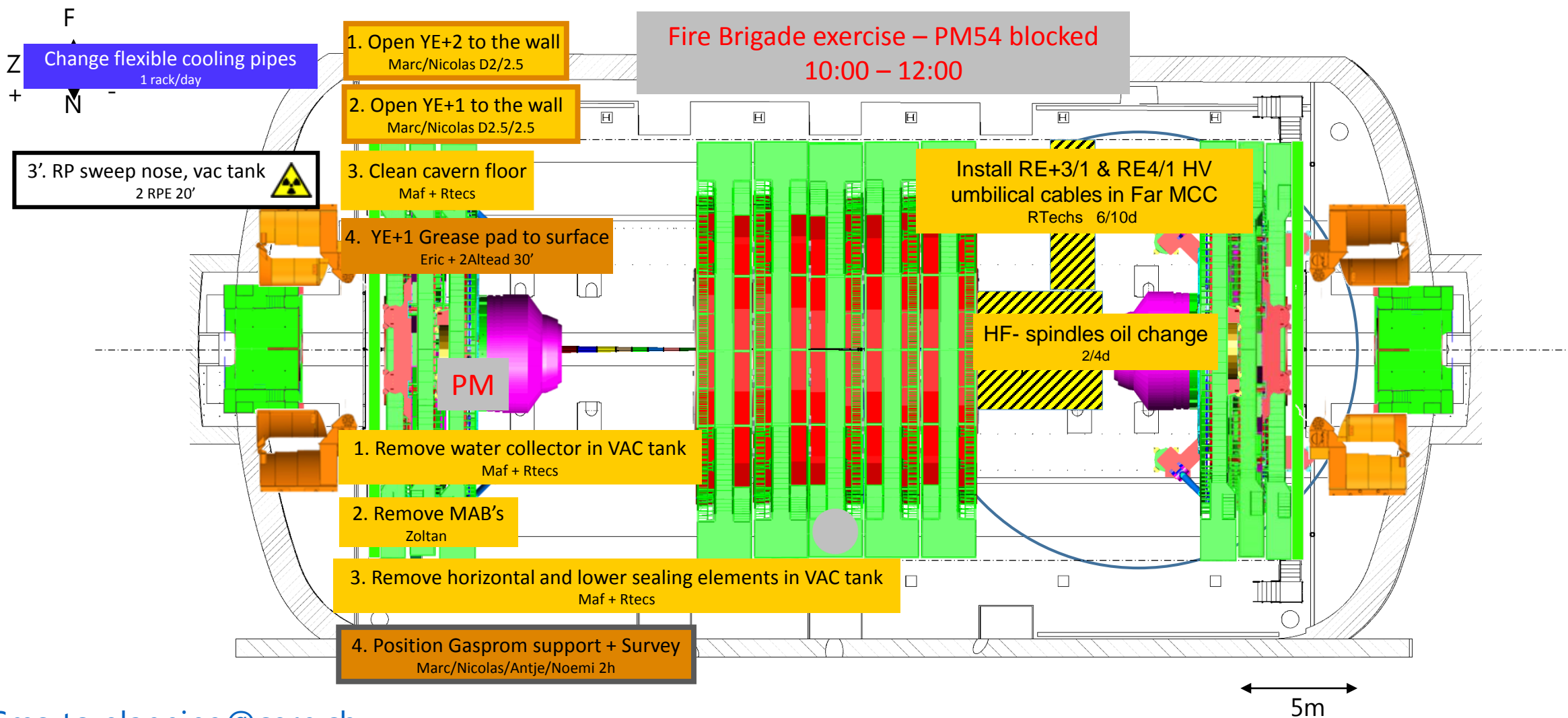



Crane

Cryo.	EL power	Water cool.	Database				
IT	Magnet	C6F14	Gas				
SL. 0	GEM	ECAL	ZEC	DT+ RB	Survey	TE-VSC	SMB
CP. 0	TOTEM	CMX	CSC RE	TK PIX	HCAL	EN Dept	RP

PX56 Plug OPEN
TX54 Plug OPEN

Wednesday
16. January 2019

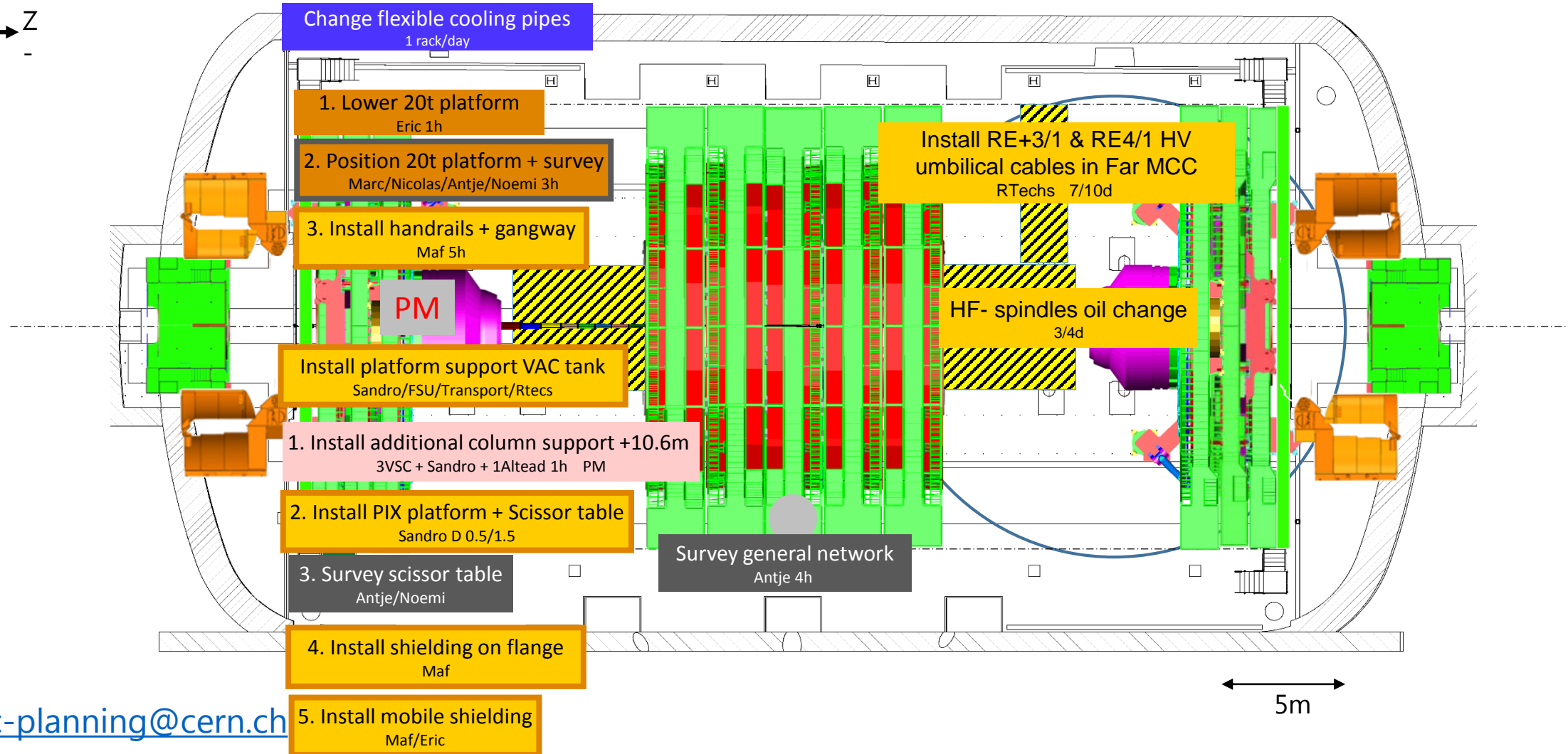
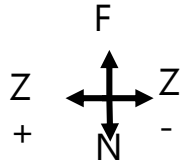



Crane

Cryo.	■	EL power	■	Water cool.	■	Database	■								
IT	■	Magnet	■	C6F14	■	Gas	■								
SL.	0	GEM	■	ECAL	■	ZEC	■	DT+ RB	■	Survey	■	TE-VSC	■	SMB	■
CP.	0	TOTEM	■	CMX	■	CSC RE	■	TK PIX	■	HCAL	■	EN Dept	■	RP	■

PX56 Plug
OPEN

TX54 Plug
OPEN

Thursday

17. January 2019

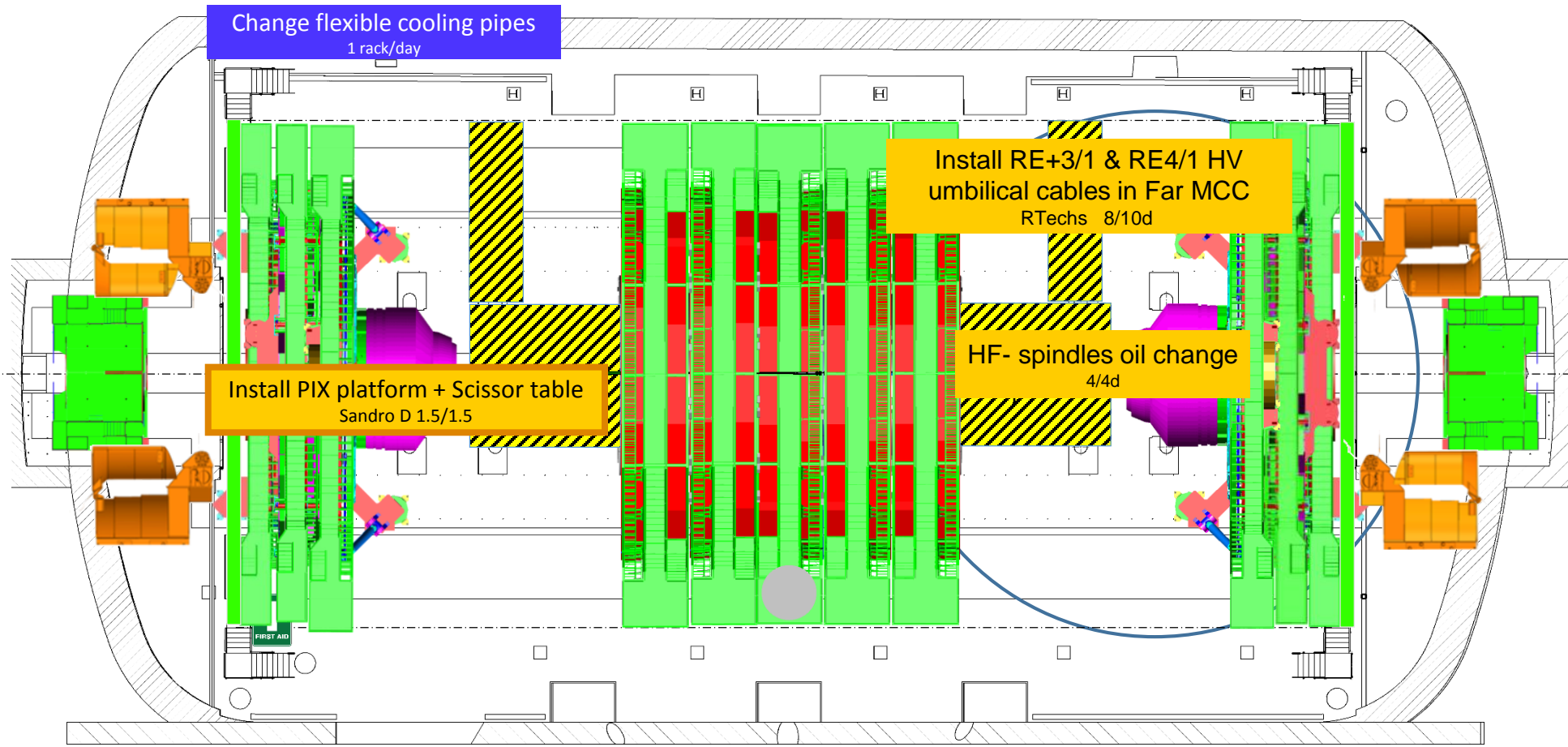
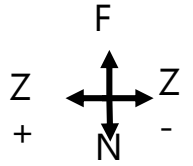

5m



Crane

Cryo.	EL power	Water cool.	Database				
IT	Magnet	C6F14	Gas				
SL. 0	GEM	ECAL	ZEC	DT+ RB	Survey	TE-VSC	SMB
CP. 0	TOTEM	CMX	CSC RE	TK PIX	HCAL	EN Dept	RP

PX56 Plug OPEN
TX54 Plug OPEN

Friday
18. January 2019

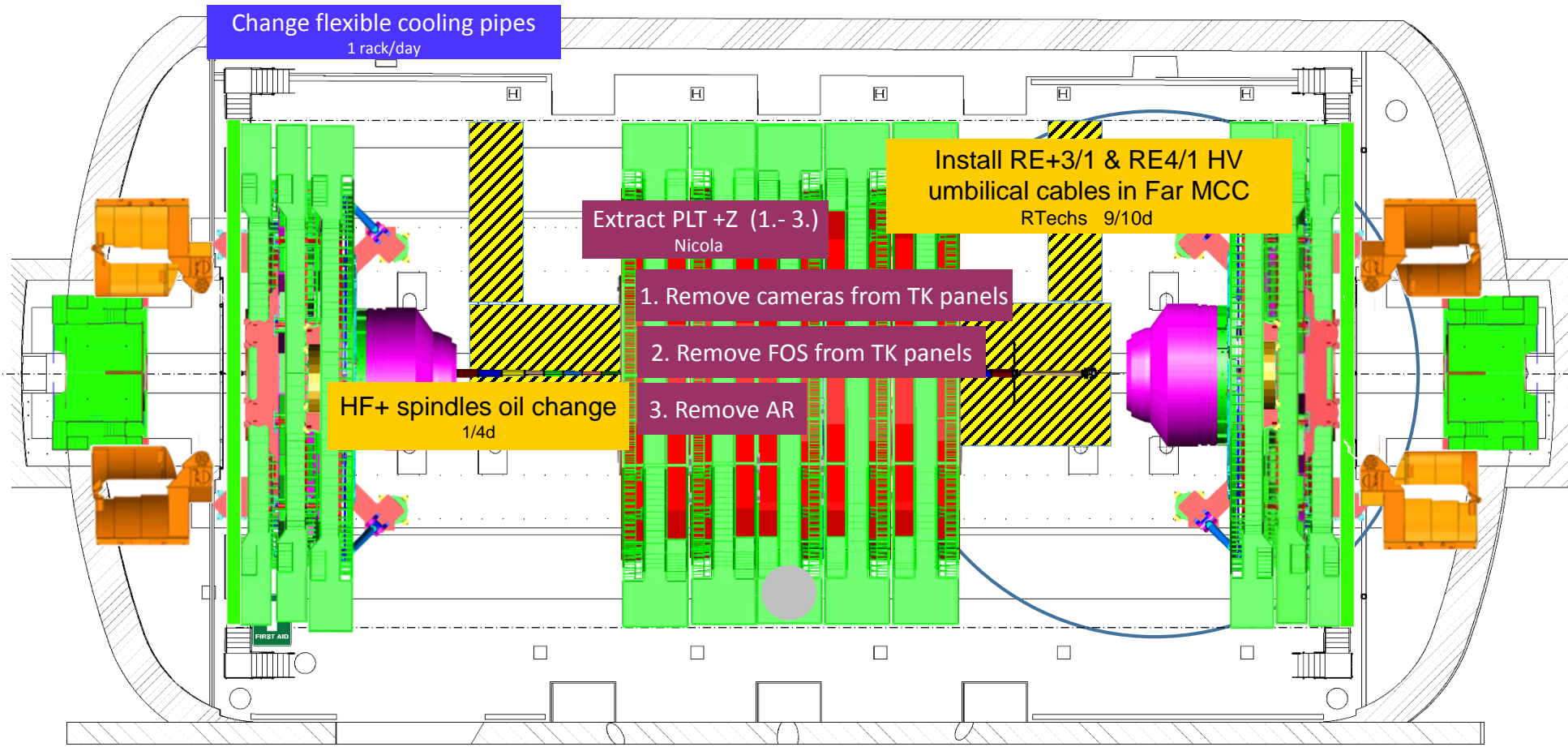
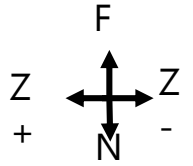

5m



Crane

Cryo.	EL power	Water cool.	Database				
IT	Magnet	C6F14	Gas				
SL. 0	GEM	ECAL	ZEC	DT+ RB	Survey	TE-VSC	SMB
CP. 0	TOTEM	CMX	CSC RE	TK PIX	HCAL	EN Dept	RP

PX56 Plug OPEN
TX54 Plug OPEN

Saturday
19. January 2019

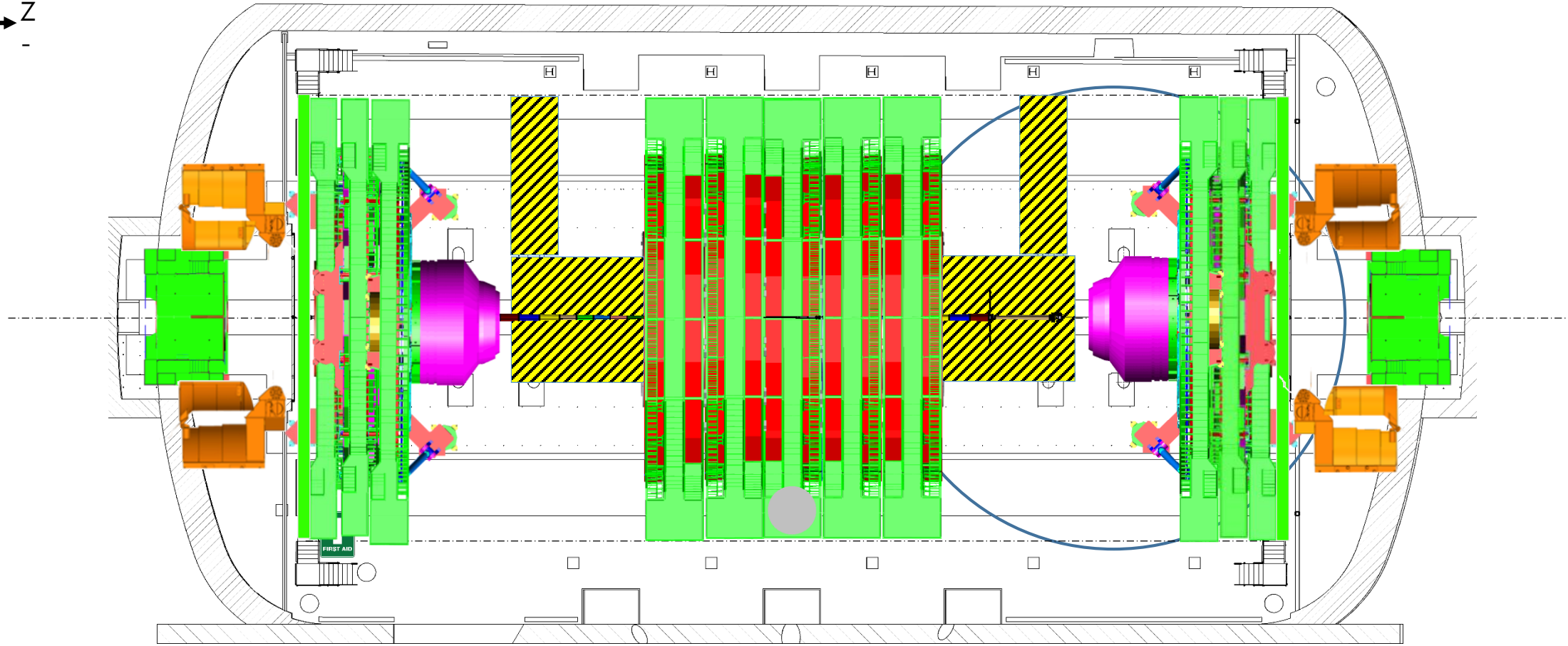
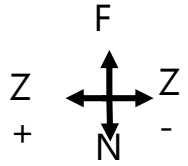

5m



Crane

Cryo.	EL power	Water cool.	Database				
IT	Magnet	C6F14	Gas				
SL. 0	GEM	ECAL	ZEC	DT+ RB	Survey	TE-VSC	SMB
CP. 0	TOTEM	CMX	CSC RE	TK PIX	HCAL	EN Dept	RP

PX56 Plug OPEN

Sunday

TX54 Plug OPEN

20. January 2019

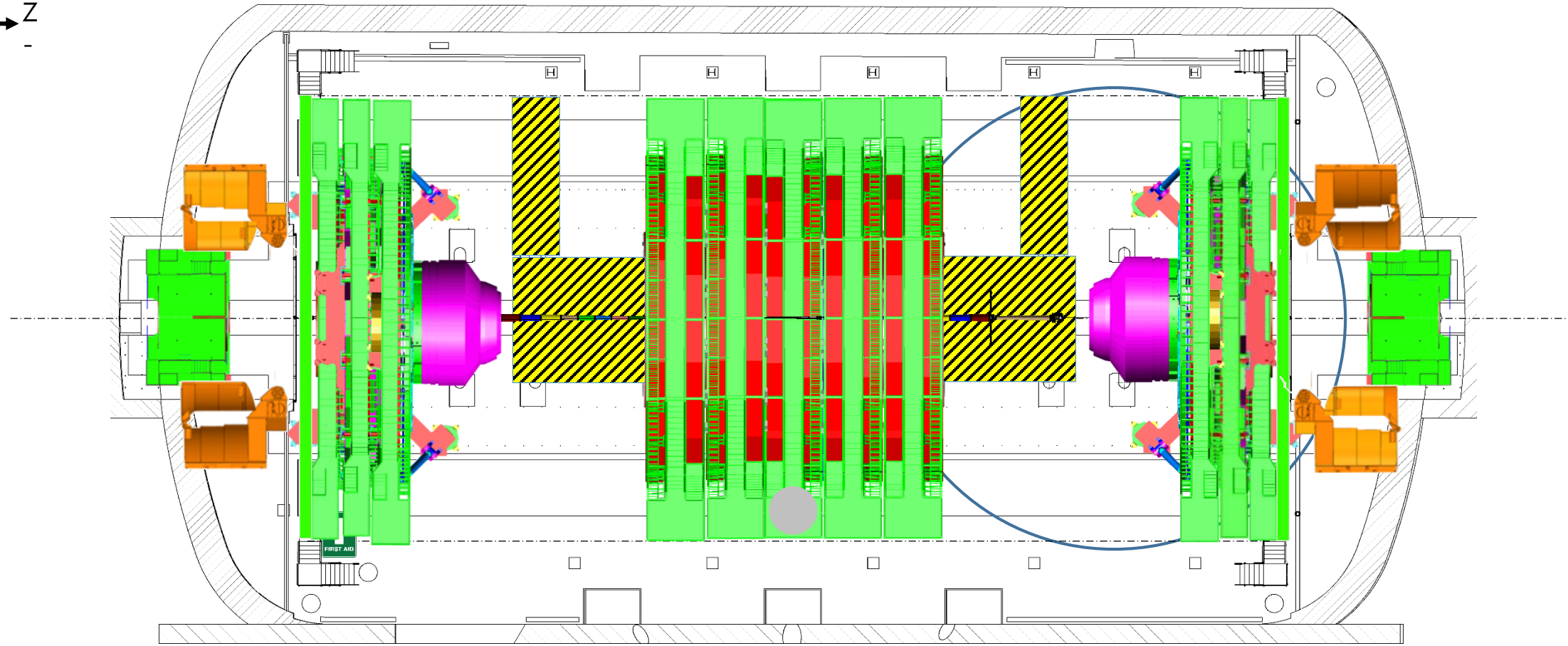
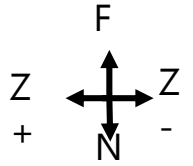

5m



Crane

Cryo.	EL power	Water cool.	Database				
IT	Magnet	C6F14	Gas				
SL. 0	GEM	ECAL	ZEC	DT+ RB	Survey	TE-VSC	SMB
CP. 0	TOTEM	CMX	CSC RE	TK PIX	HCAL	EN Dept	RP

PX56 Plug OPEN
TX54 Plug OPEN

Monday
21. January 2019

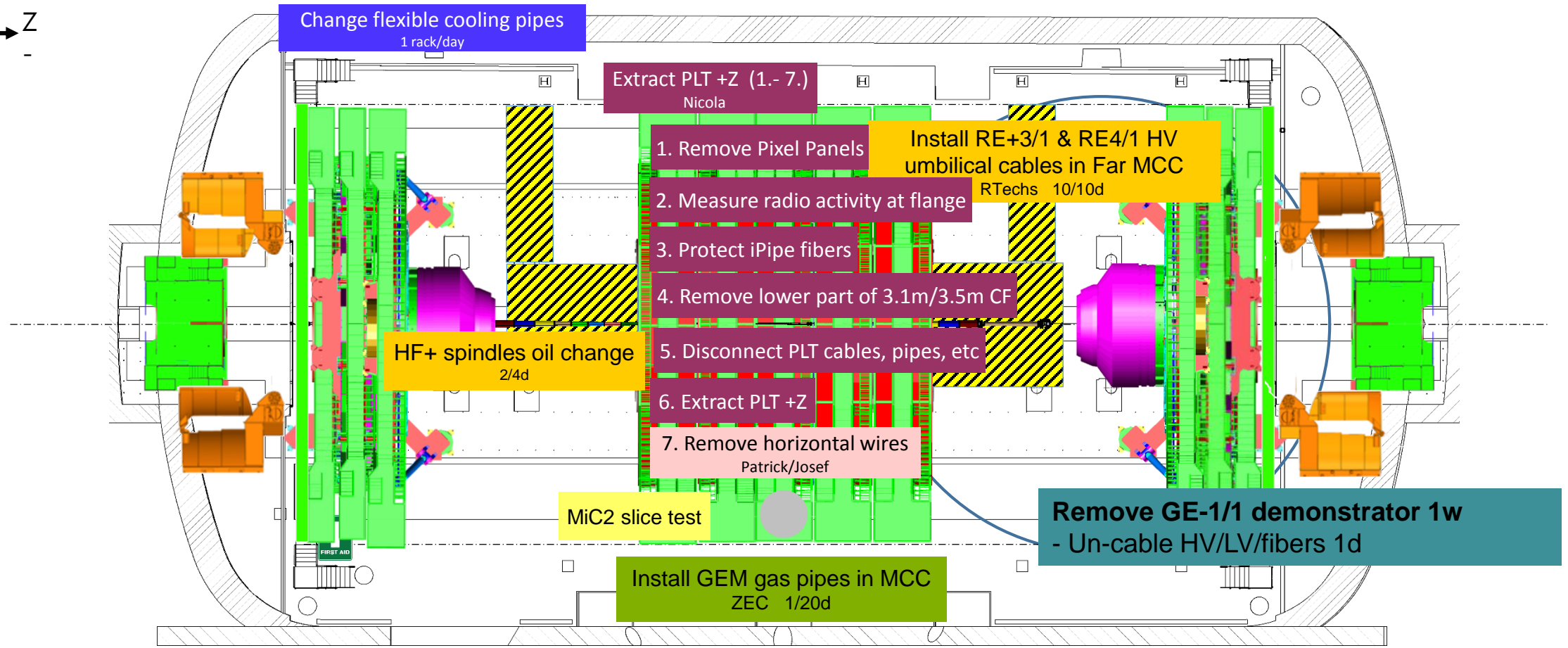
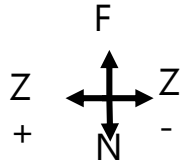

5m



Crane

Cryo.	EL power	Water cool.	Database				
IT	Magnet	C6F14	Gas				
SL. 0	GEM	ECAL	ZEC	DT+ RB	Survey	TE-VSC	SMB
CP. 0	TOTEM	CMX	CSC RE	TK PIX	HCAL	EN Dept	RP

PX56 Plug OPEN
TX54 Plug OPEN

Tuesday
22. January 2019

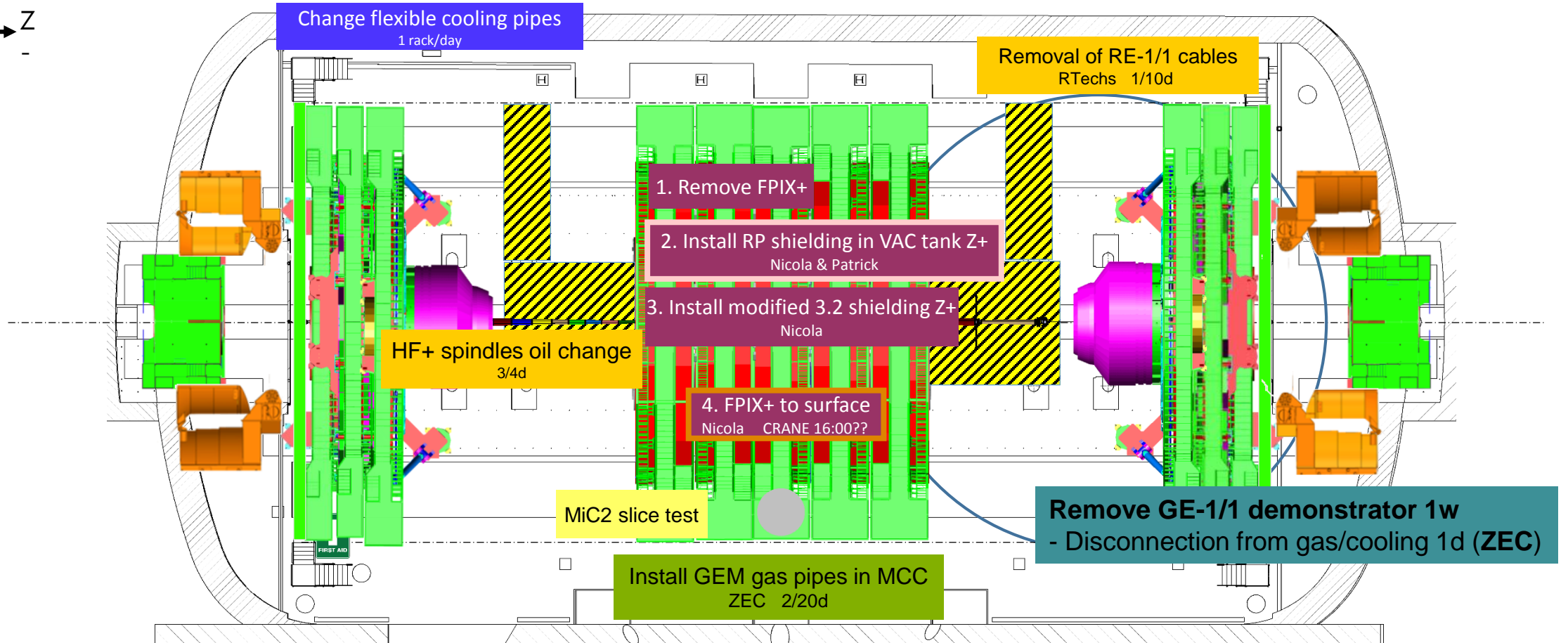
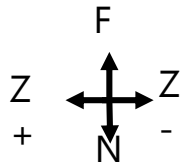

5m



Crane

Cryo.	EL power	Water cool.	Database				
IT	Magnet	C6F14	Gas				
SL. 0	GEM	ECAL	ZEC	DT+ RB	Survey	TE-VSC	SMB
CP. 0	TOTEM	CMX	CSC RE	TK PIX	HCAL	EN Dept	RP

PX56 Plug OPEN
TX54 Plug OPEN

Wednesday
23. January 2019

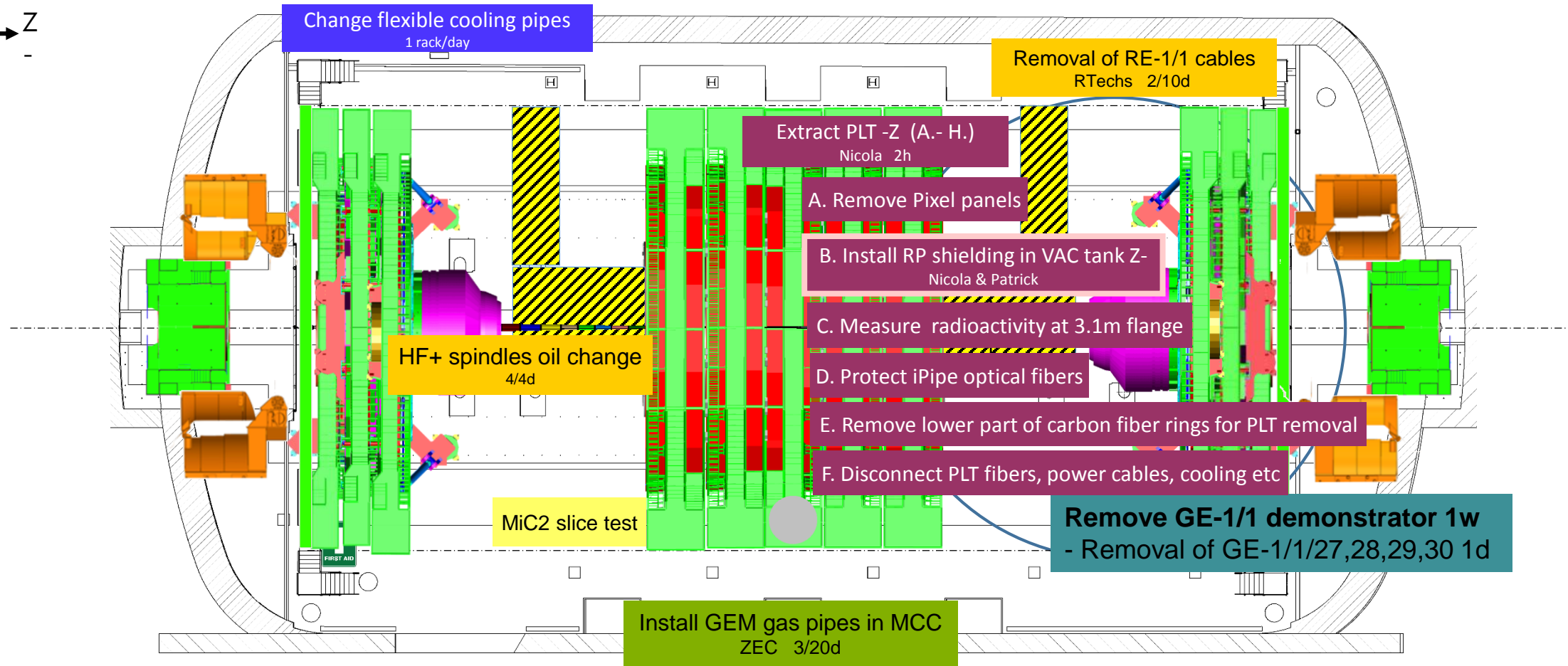
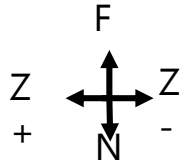

5m



Crane

Cryo.	EL power	Water cool.	Database				
IT	Magnet	C6F14	Gas				
SL. 0	GEM	ECAL	ZEC	DT+ RB	Survey	TE-VSC	SMB
CP. 0	TOTEM	CMX	CSC RE	TK PIX	HCAL	EN Dept	RP

PX56 Plug OPEN
TX54 Plug OPEN

Thursday
24. January 2019

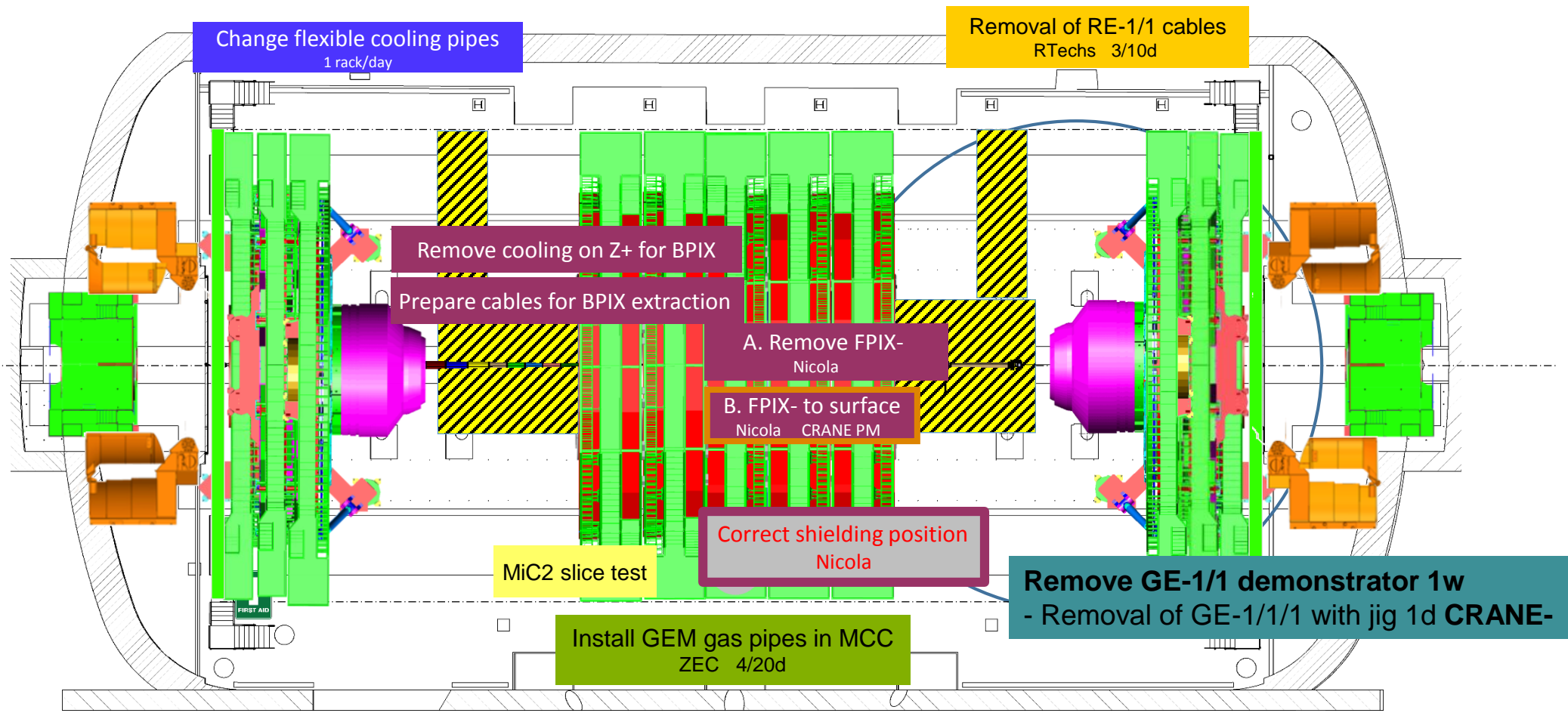
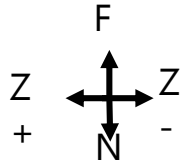

5m



Crane

Cryo.	EL power	Water cool.	Database				
IT	Magnet	C6F14	Gas				
SL. 0	GEM	ECAL	ZEC	DT+ RB	Survey	TE-VSC	SMB
CP. 0	TOTEM	CMX	CSC RE	TK PIX	HCAL	EN Dept	RP

PX56 Plug OPEN
TX54 Plug OPEN

Friday
25. January 2019

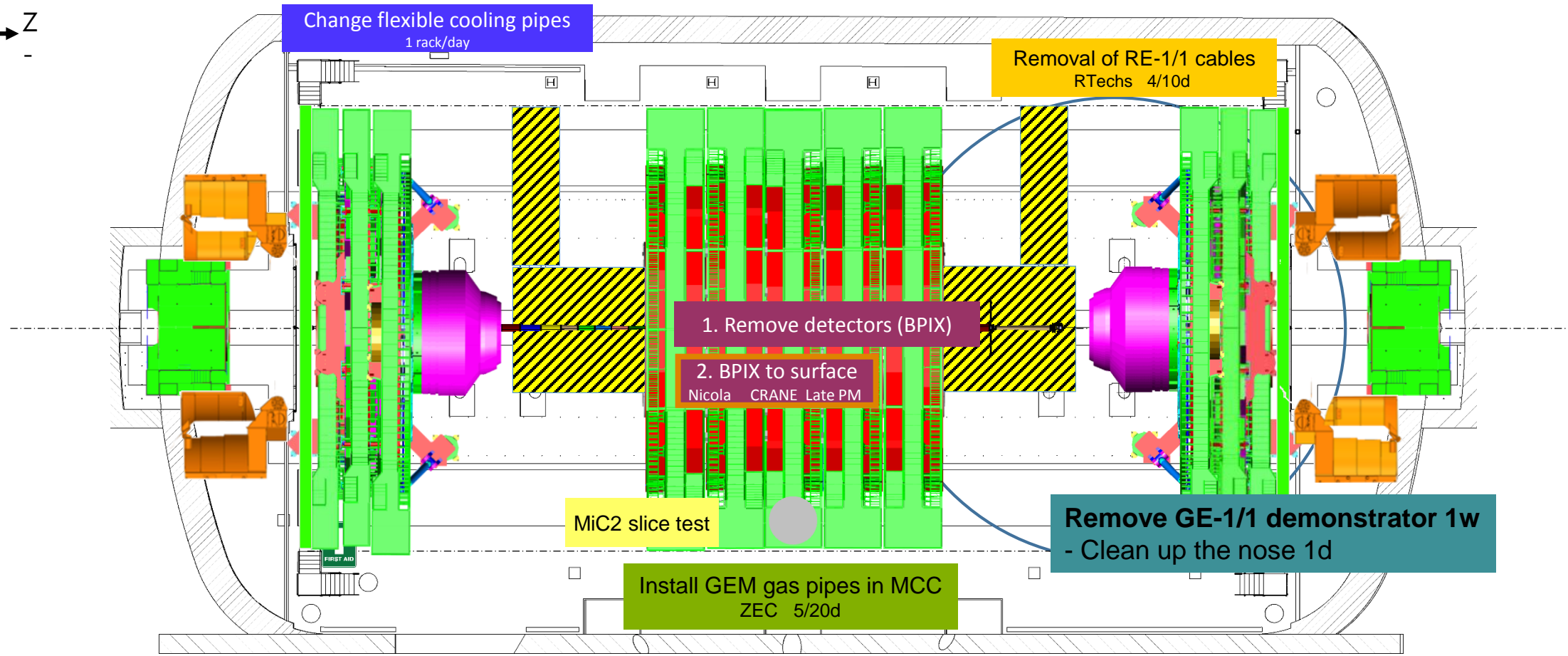
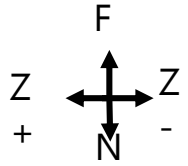

5m



Crane

Cryo.	EL power	Water cool.	Database				
IT	Magnet	C6F14	Gas				
SL. 0	GEM	ECAL	ZEC	DT+ RB	Survey	TE-VSC	SMB
CP. 0	TOTEM	CMX	CSC RE	TK PIX	HCAL	EN Dept	RP

PX56 Plug
OPEN

TX54 Plug
OPEN

Saturday

26. January 2019

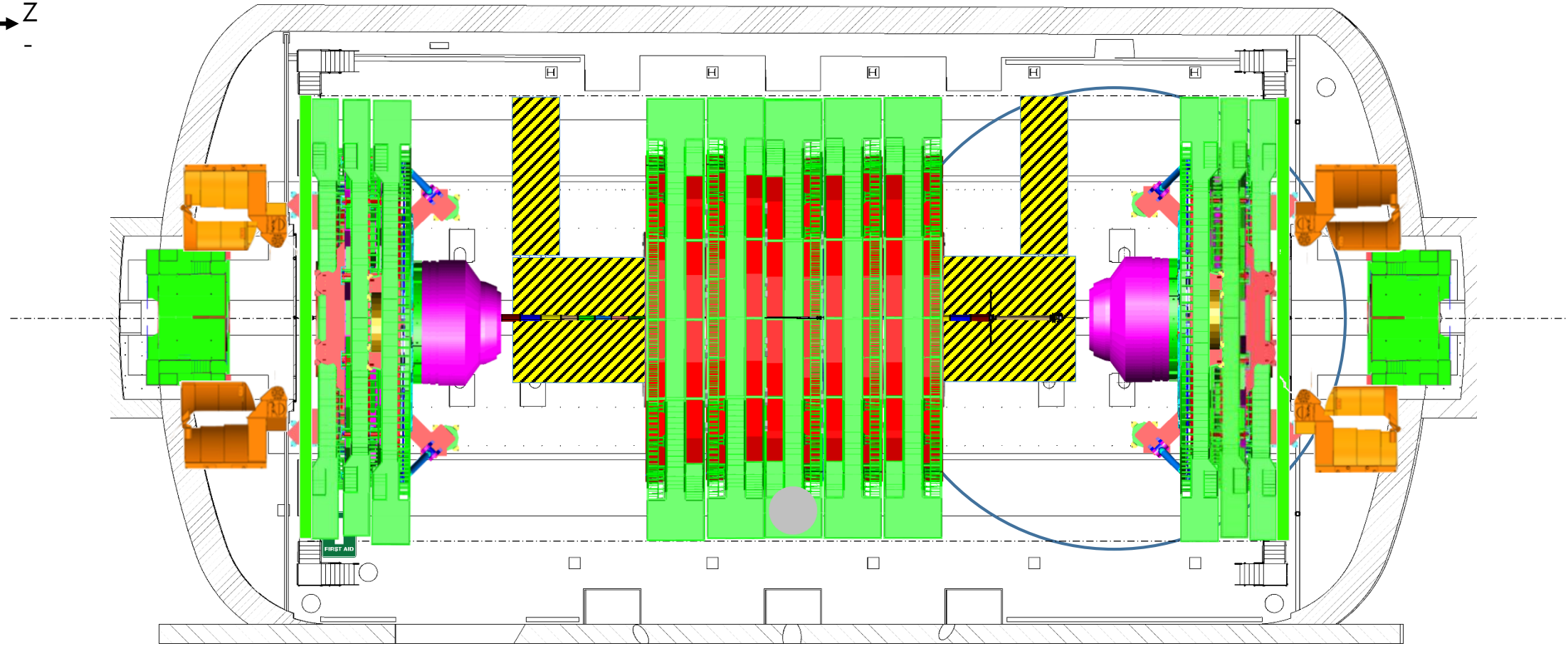
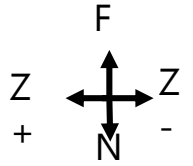

5m



Crane

Cryo.	EL power	Water cool.	Database				
IT	Magnet	C6F14	Gas				
SL. 0	GEM	ECAL	ZEC	DT+ RB	Survey	TE-VSC	SMB
CP. 0	TOTEM	CMX	CSC RE	TK PIX	HCAL	EN Dept	RP

PX56 Plug OPEN
TX54 Plug OPEN

Sunday
27. January 2019

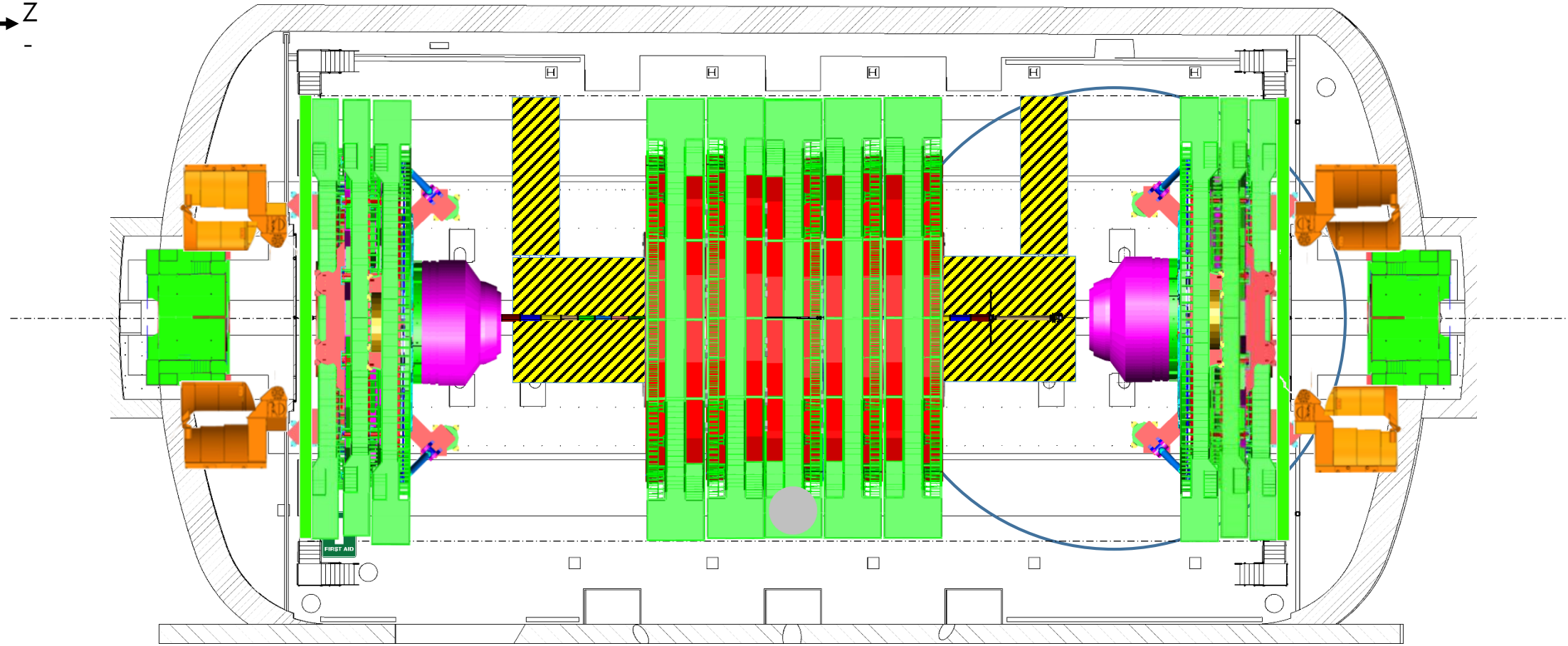
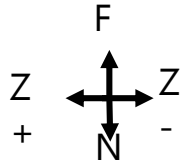

5m



Crane

Cryo.	EL power	Water cool.	Database				
IT	Magnet	C6F14	Gas				
SL. 0	GEM	ECAL	ZEC	DT+ RB	Survey	TE-VSC	SMB
CP. 0	TOTEM	CMX	CSC RE	TK PIX	HCAL	EN Dept	RP

PX56 Plug OPEN
TX54 Plug OPEN

Monday
28. January 2019

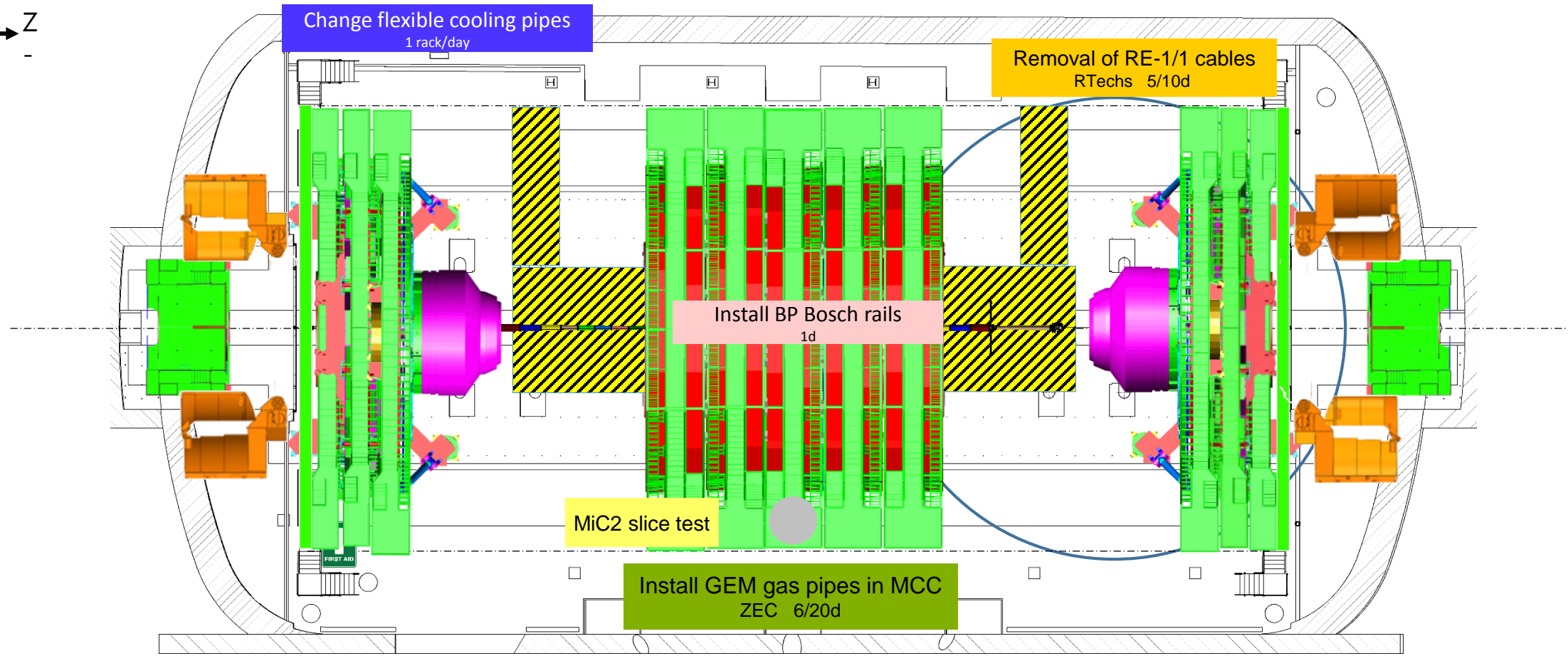
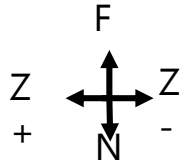



Crane

Cryo.	EL power	Water cool.	Database				
IT	Magnet	C6F14	Gas				
SL. 0	GEM	ECAL	ZEC	DT+ RB	Survey	TE-VSC	SMB
CP. 0	TOTEM	CMX	CSC RE	TK PIX	HCAL	EN Dept	RP

PX56 Plug OPEN
TX54 Plug OPEN

Tuesday
29. January 2019

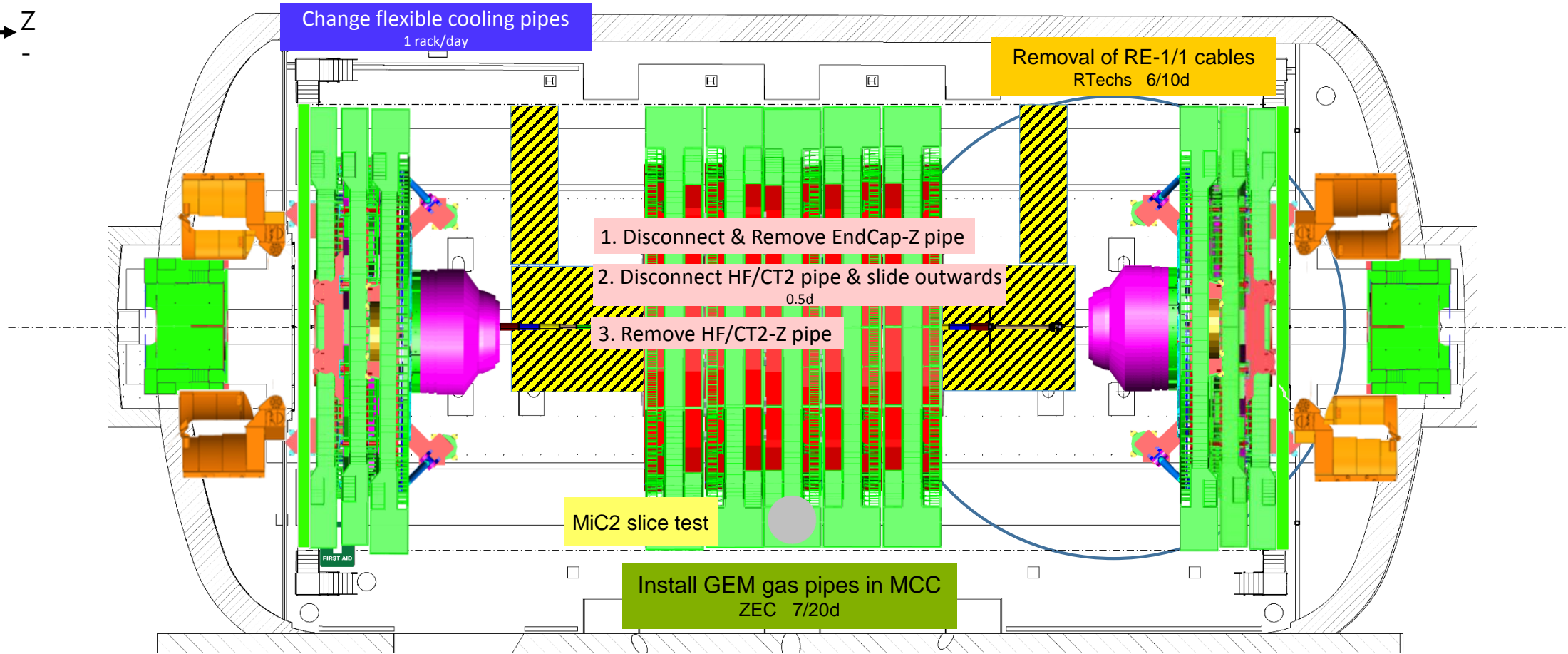
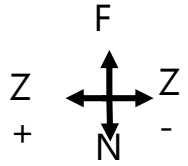

5m



Crane

Cryo.	EL power	Water cool.	Database				
IT	Magnet	C6F14	Gas				
SL. 0	GEM	ECAL	ZEC	DT+ RB	Survey	TE-VSC	SMB
CP. 0	TOTEM	CMX	CSC RE	TK PIX	HCAL	EN Dept	RP

PX56 Plug OPEN
TX54 Plug OPEN

Wednesday
30. January 2019

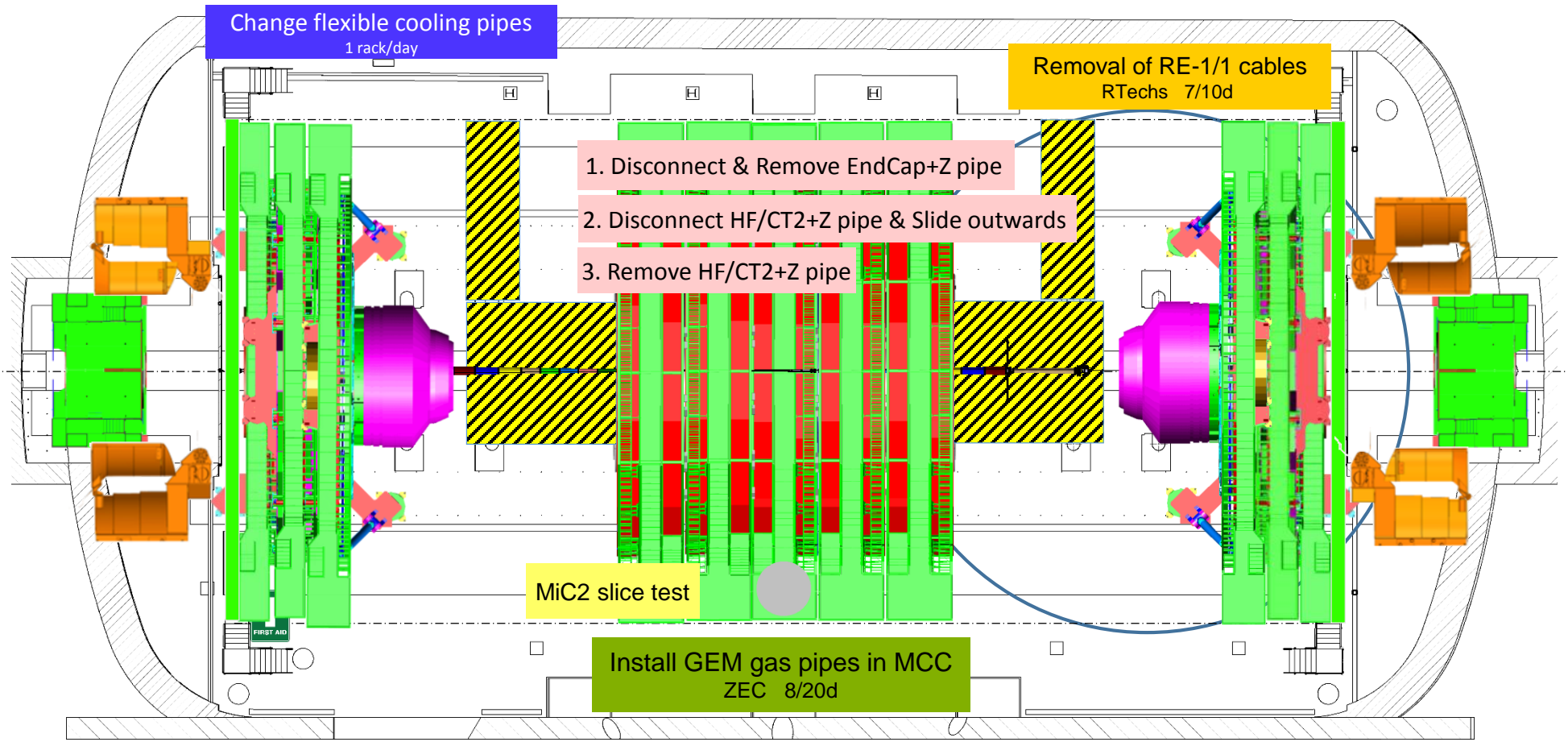

Change flexible cooling pipes
1 rack/day

Removal of RE-1/1 cables
RTechs 7/10d

1. Disconnect & Remove EndCap+Z pipe
2. Disconnect HF/CT2+Z pipe & Slide outwards
3. Remove HF/CT2+Z pipe

MiC2 slice test

Install GEM gas pipes in MCC
ZEC 8/20d

5m



Crane

Cryo.	EL power	Water cool.	Database				
IT	Magnet	C6F14	Gas				
SL. 0	GEM	ECAL	ZEC	DT+ RB	Survey	TE-VSC	SMB
CP. 0	TOTEM	CMX	CSC RE	TK PIX	HCAL	EN Dept	RP

PX56 Plug OPEN
TX54 Plug OPEN

Thursday
31. January 2019

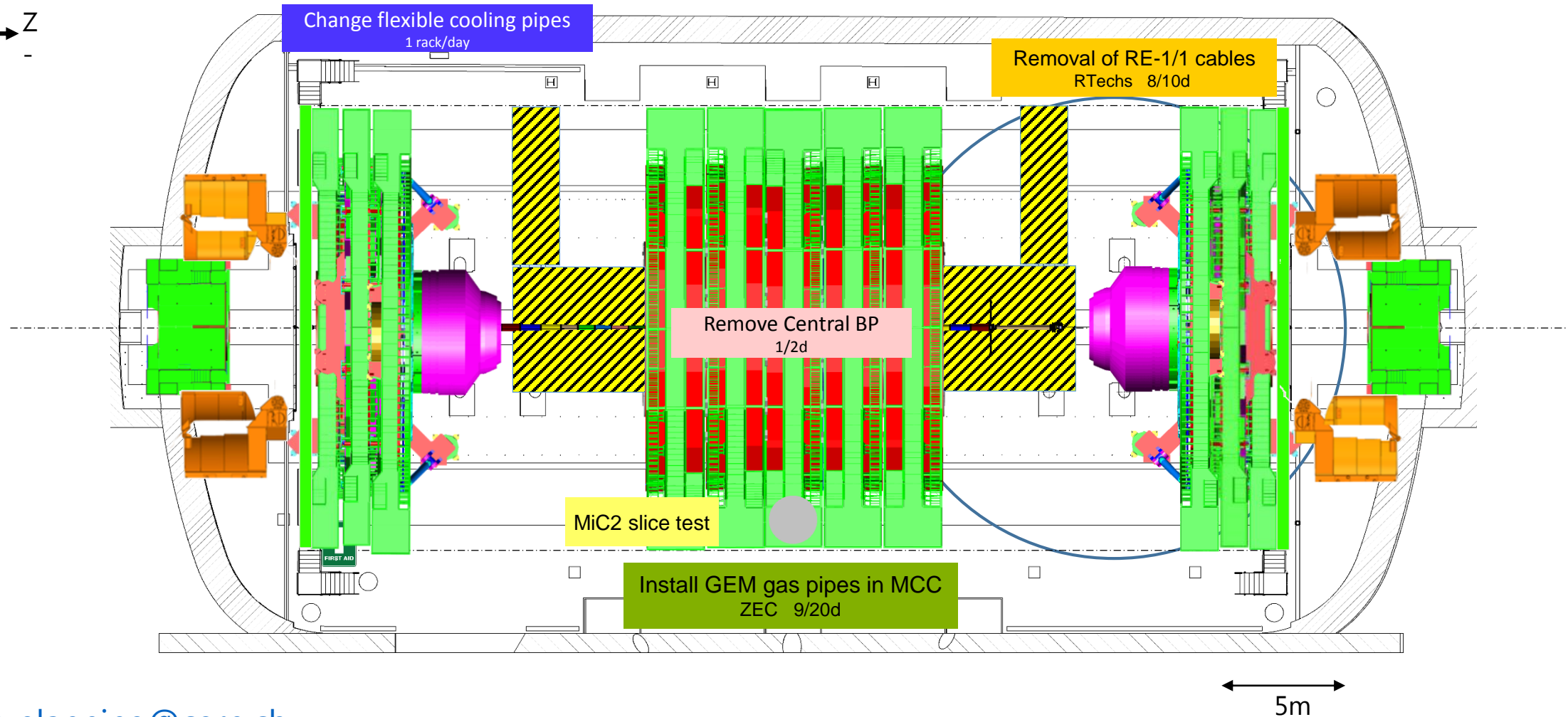
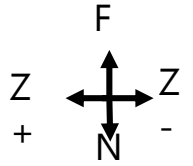



Crane

Cryo.	EL power	Water cool.	Database				
IT	Magnet	C6F14	Gas				
SL. 0	GEM	ECAL	ZEC	DT+ RB	Survey	TE-VSC	SMB
CP. 0	TOTEM	CMX	CSC RE	TK PIX	HCAL	EN Dept	RP

PX56 Plug OPEN
TX54 Plug OPEN

Friday
01. February 2019

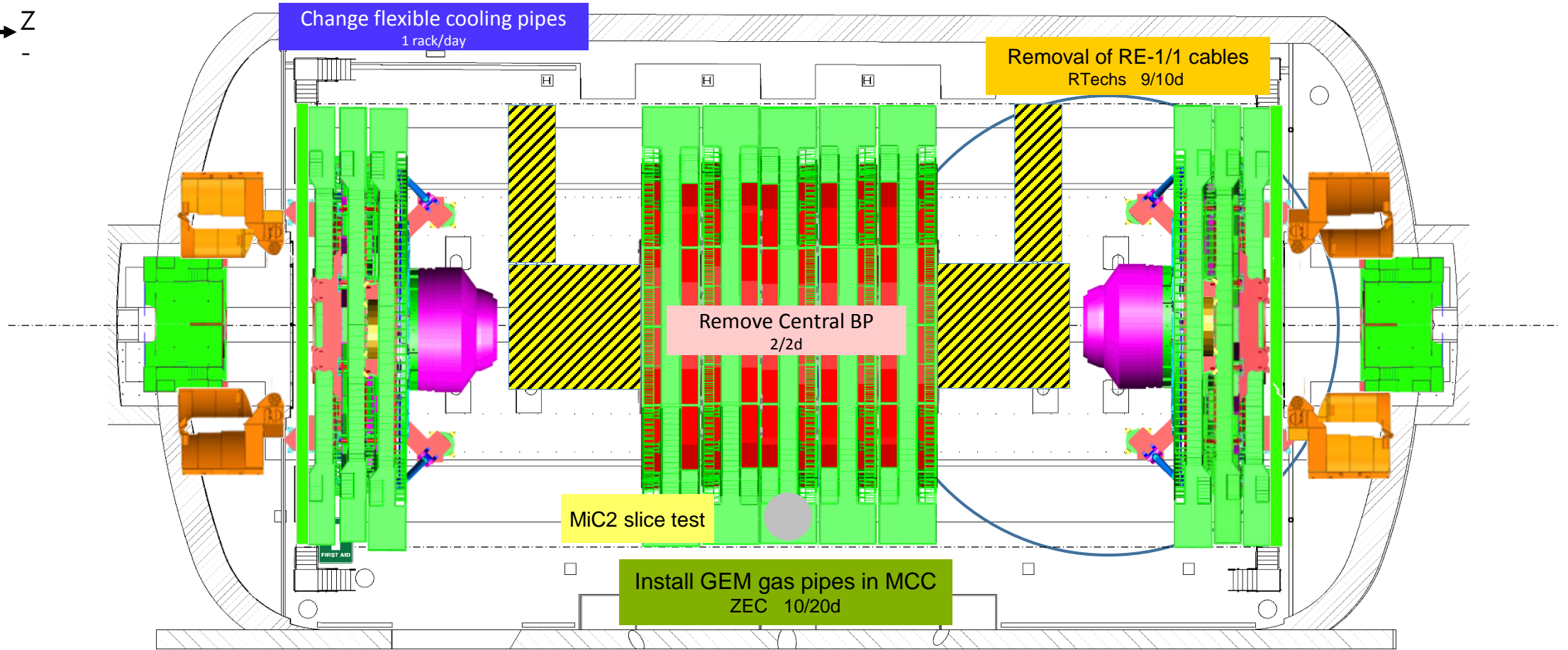
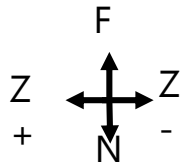

5m



Crane

Cryo.	EL power	Water cool.	Database				
IT	Magnet	C6F14	Gas				
SL. 0	GEM	ECAL	ZEC	DT+ RB	Survey	TE-VSC	SMB
CP. 0	TOTEM	CMX	CSC RE	TK PIX	HCAL	EN Dept	RP

PX56 Plug
OPEN

TX54 Plug
OPEN

Saturday

02. February 2019

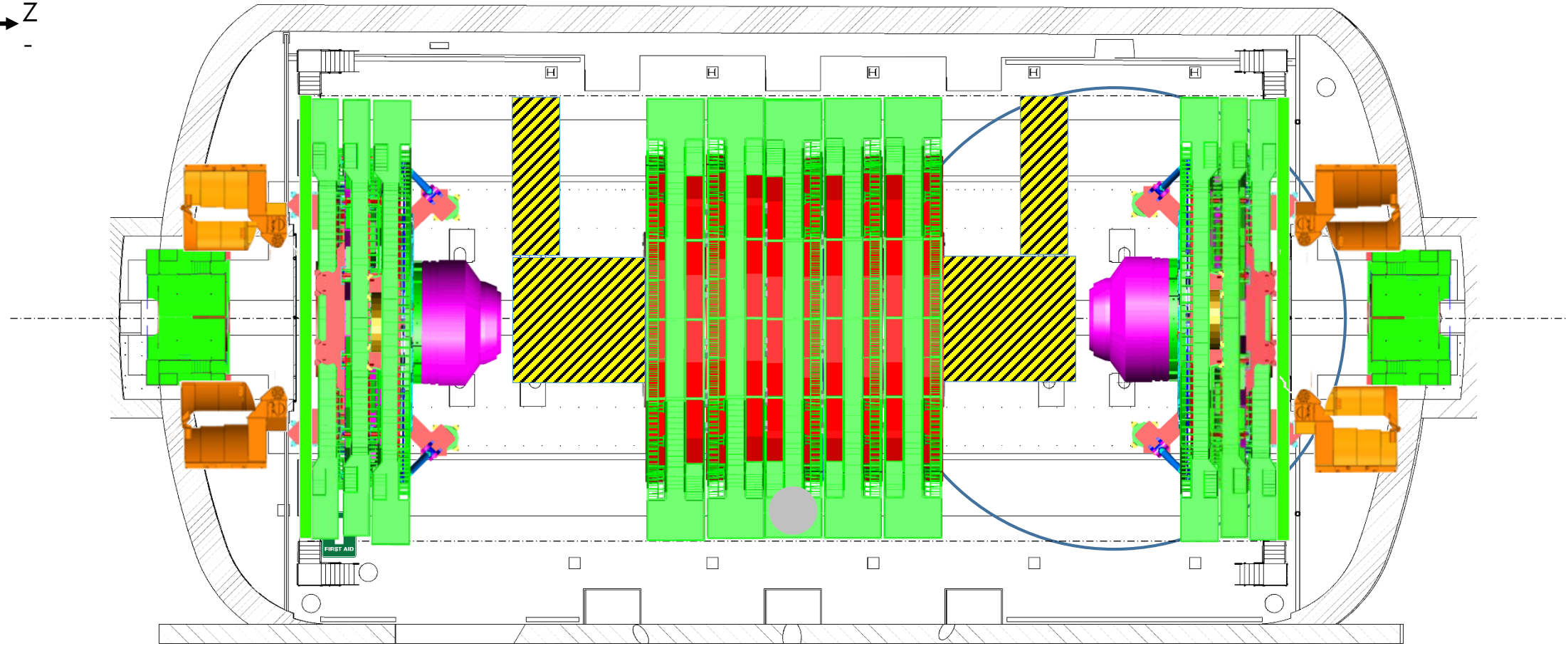
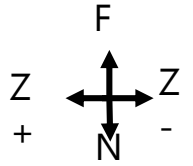

5m



Crane

Cryo.	EL power	Water cool.	Database				
IT	Magnet	C6F14	Gas				
SL. 0	GEM	ECAL	ZEC	DT+ RB	Survey	TE-VSC	SMB
CP. 0	TOTEM	CMX	CSC RE	TK PIX	HCAL	EN Dept	RP

PX56 Plug OPEN

Sunday

TX54 Plug OPEN

03. February 2019

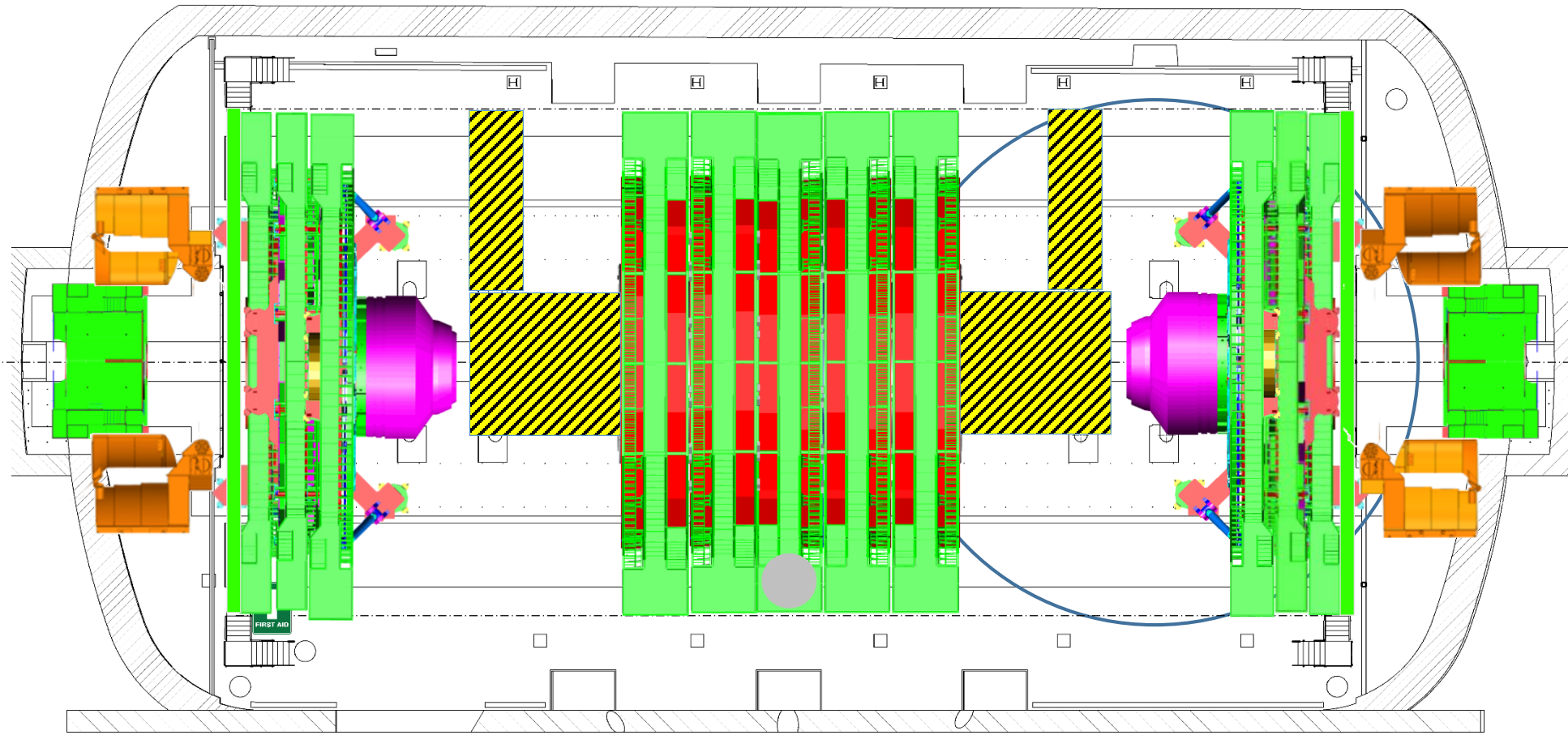
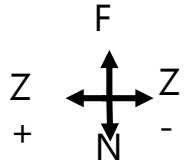

5m



Crane

Cryo.	EL power	Water cool.	Database				
IT	Magnet	C6F14	Gas				
SL. 0	GEM	ECAL	ZEC	DT+ RB	Survey	TE-VSC	SMB
CP. 0	TOTEM	CMX	CSC RE	TK PIX	HCAL	EN Dept	RP

PX56 Plug OPEN
TX54 Plug OPEN

Monday
04. February 2019

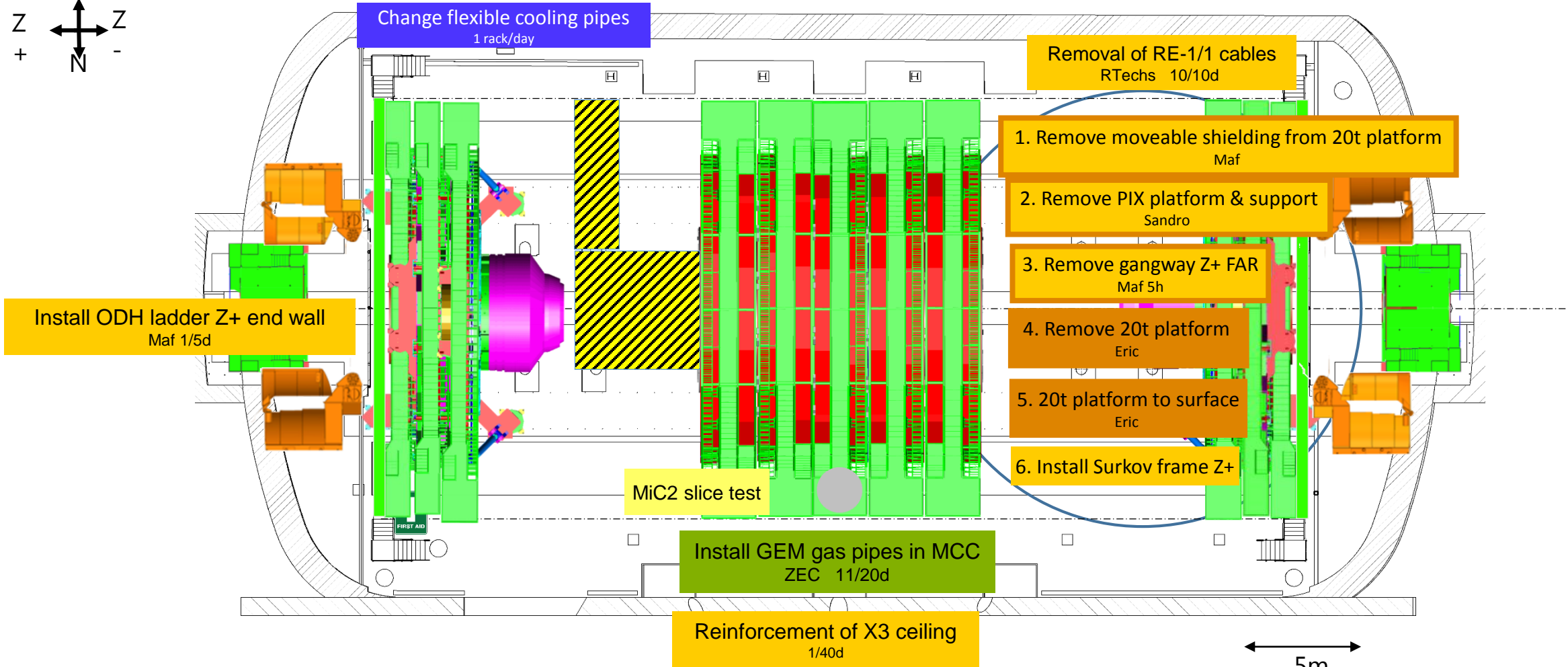
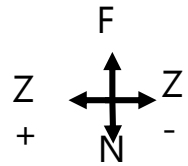



Crane

Cryo.	EL power	Water cool.	Database				
IT	Magnet	C6F14	Gas				
SL. 0	GEM	ECAL	ZEC	DT+ RB	Survey	TE-VSC	SMB
CP. 0	TOTEM	CMX	CSC RE	TK PIX	HCAL	EN Dept	RP

PX56 Plug OPEN
TX54 Plug OPEN

Tuesday
05. February 2019

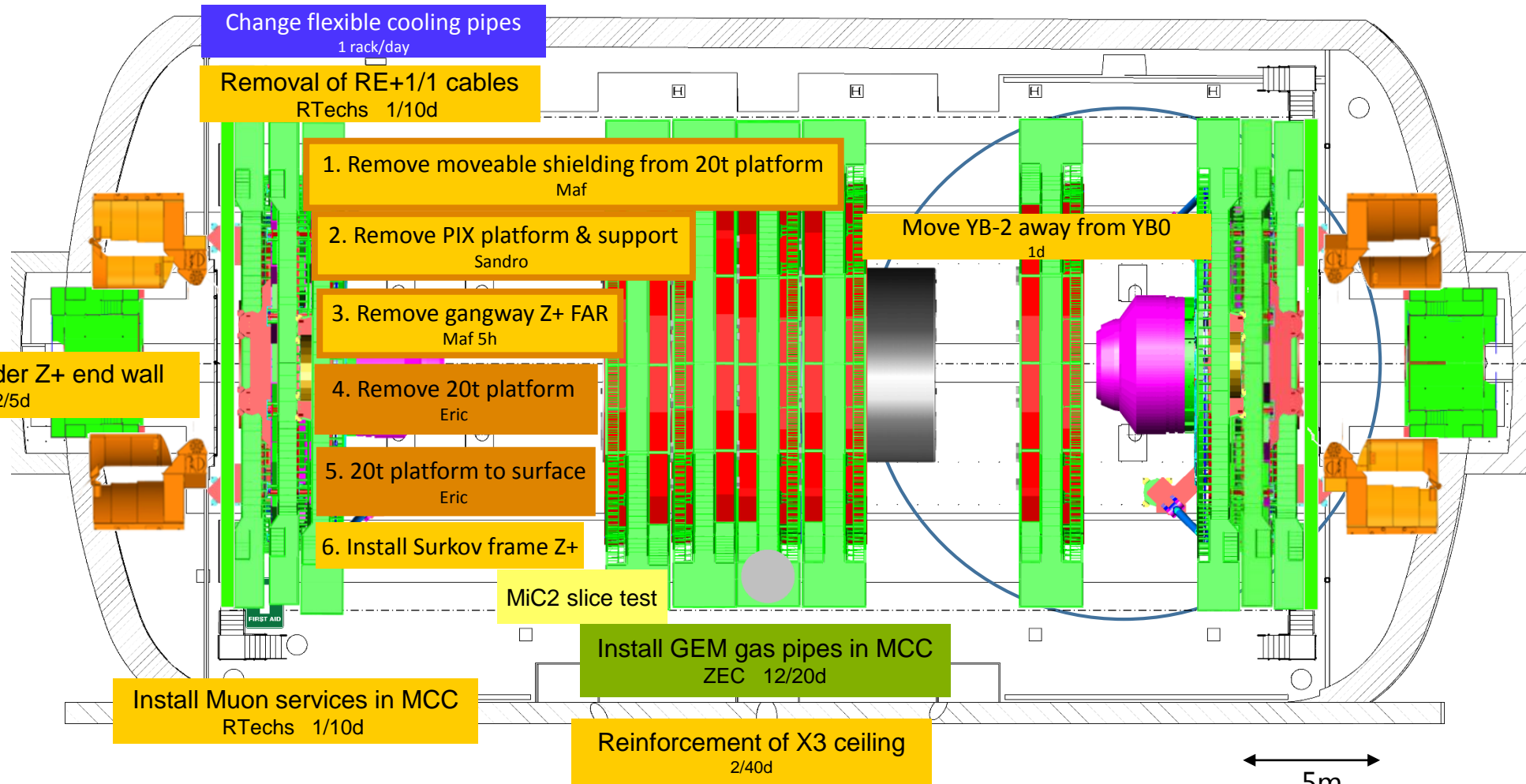
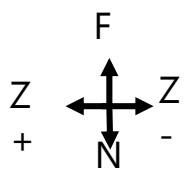

5m



Crane

Cryo.	EL power	Water cool.	Database				
IT	Magnet	C6F14	Gas				
SL. 0	GEM	ECAL	ZEC	DT+ RB	Survey	TE-VSC	SMB
CP. 0	TOTEM	CMX	CSC RE	TK PIX	HCAL	EN Dept	RP

PX56 Plug OPEN
TX54 Plug OPEN

Wednesday
06. February 2019

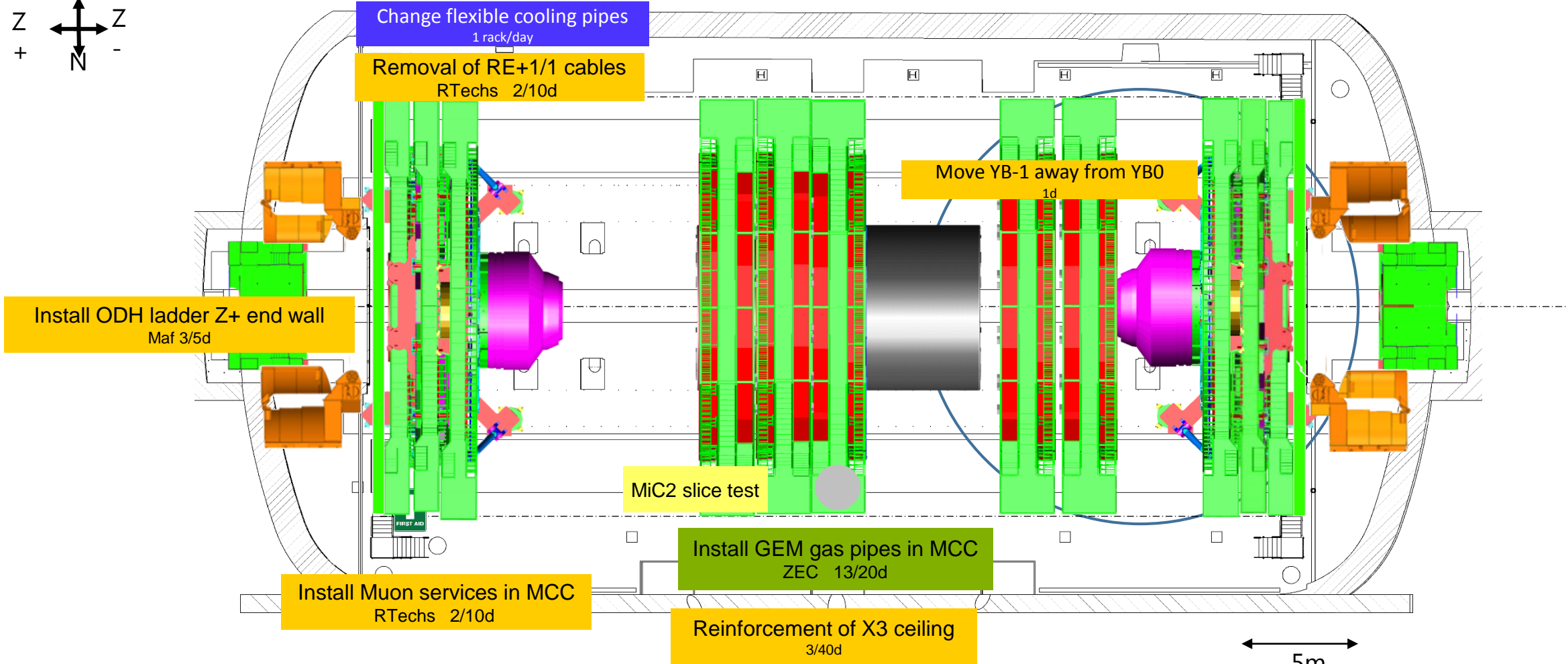
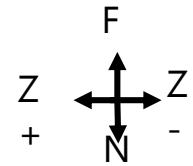



Crane

Cryo.	EL power	Water cool.	Database				
IT	Magnet	C6F14	Gas				
SL. 0	GEM	ECAL	ZEC	DT+ RB	Survey	TE-VSC	SMB
CP. 0	TOTEM	CMX	CSC RE	TK PIX	HCAL	EN Dept	RP

PX56 Plug OPEN
TX54 Plug OPEN

Thursday
07. February 2019

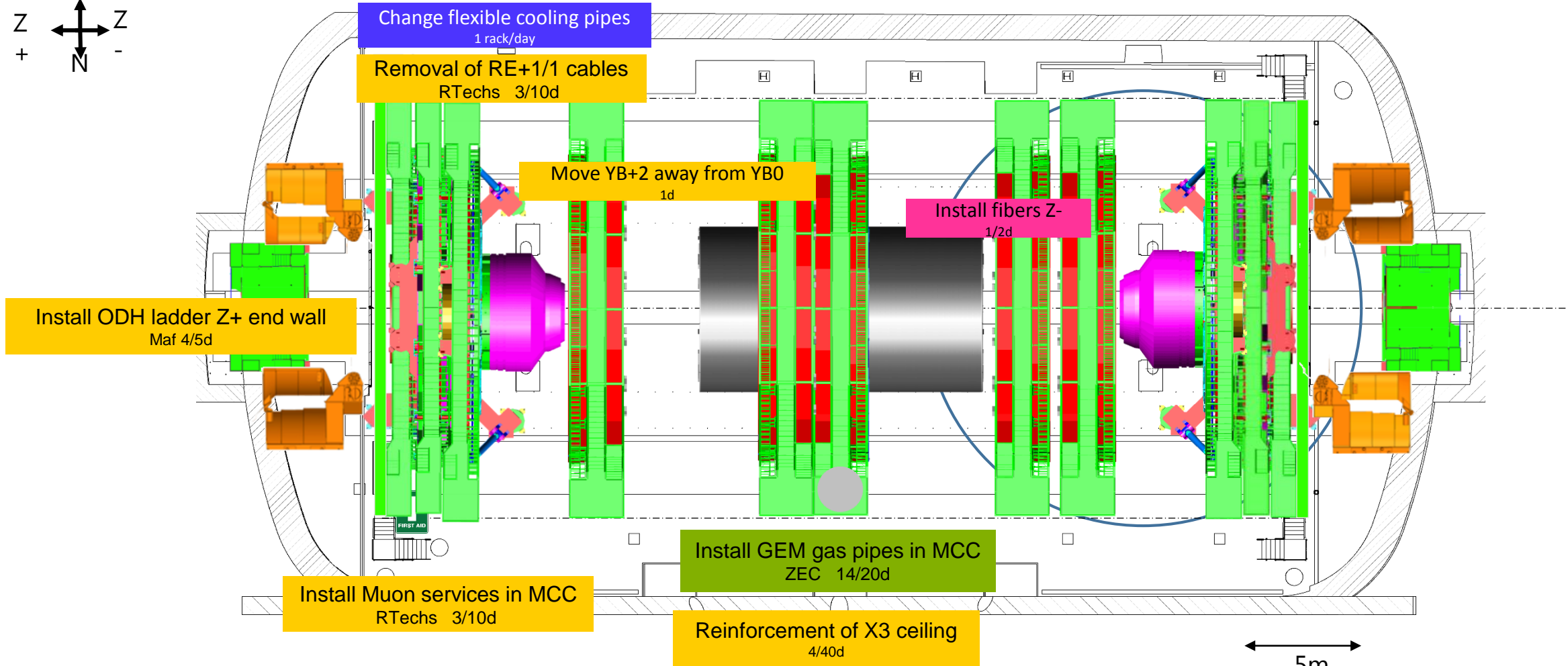
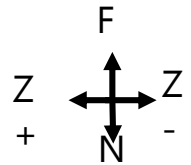



Crane

Cryo.	EL power	Water cool.	Database				
IT	Magnet	C6F14	Gas				
SL. 0	GEM	ECAL	ZEC	DT+ RB	Survey	TE-VSC	SMB
CP. 0	TOTEM	CMX	CSC RE	TK PIX	HCAL	EN Dept	RP

PX56 Plug OPEN
TX54 Plug OPEN

Friday
08. February 2019

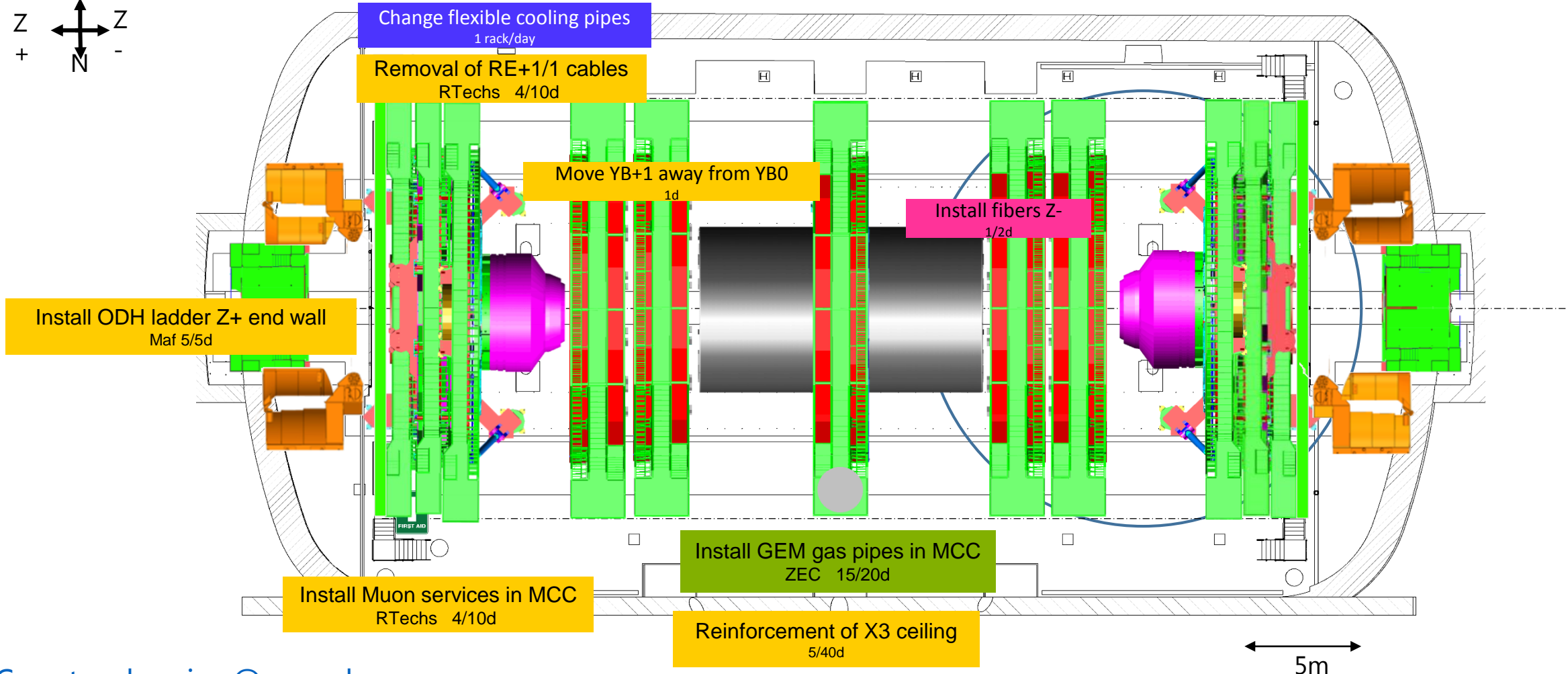
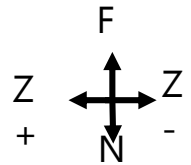



Crane

Cryo.	EL power	Water cool.	Database				
IT	Magnet	C6F14	Gas				
SL. 0	GEM	ECAL	ZEC	DT+ RB	Survey	TE-VSC	SMB
CP. 0	TOTEM	CMX	CSC RE	TK PIX	HCAL	EN Dept	RP

PX56 Plug OPEN
TX54 Plug OPEN

Saturday
09. February 2019

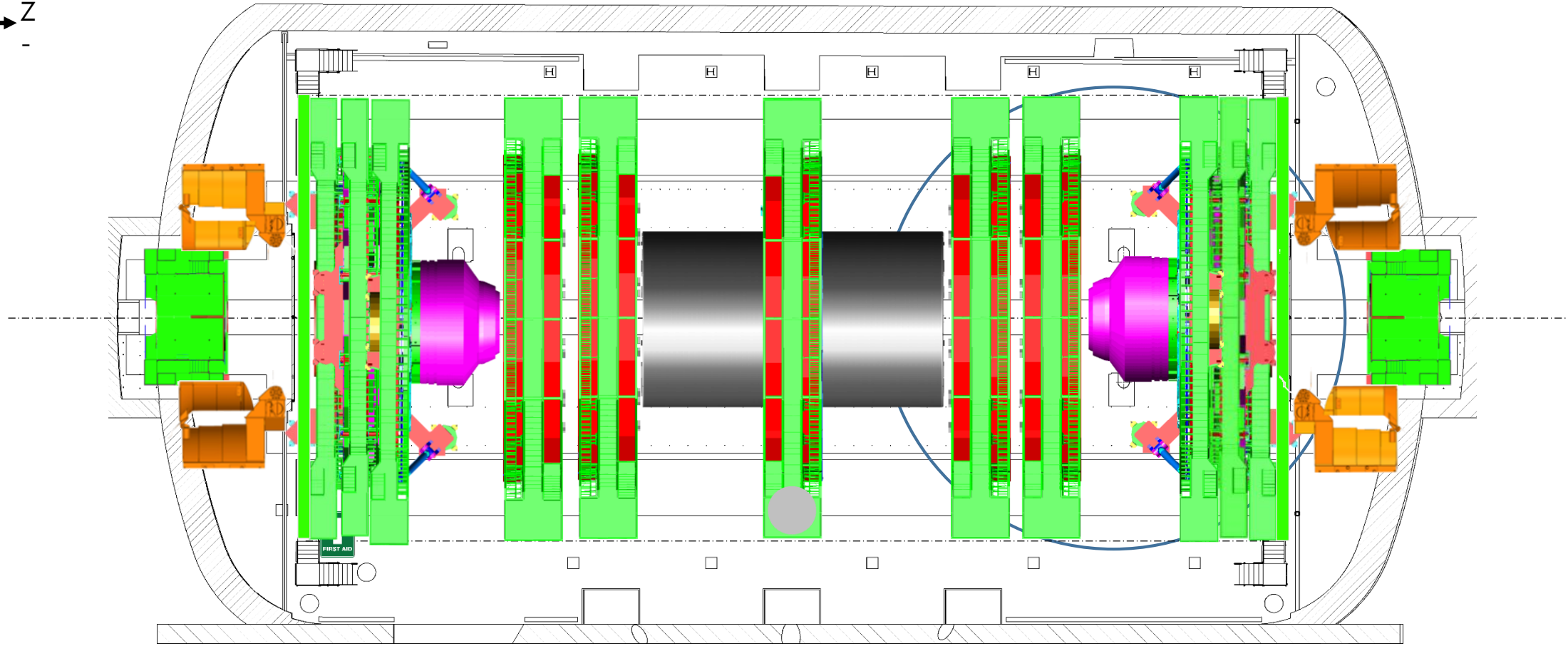
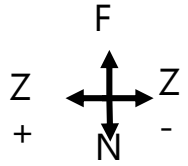

5m



Crane

Cryo.	EL power	Water cool.	Database				
IT	Magnet	C6F14	Gas				
SL. 0	GEM	ECAL	ZEC	DT+ RB	Survey	TE-VSC	SMB
CP. 0	TOTEM	CMX	CSC RE	TK PIX	HCAL	EN Dept	RP

PX56 Plug OPEN
TX54 Plug OPEN

Sunday
10. February 2019

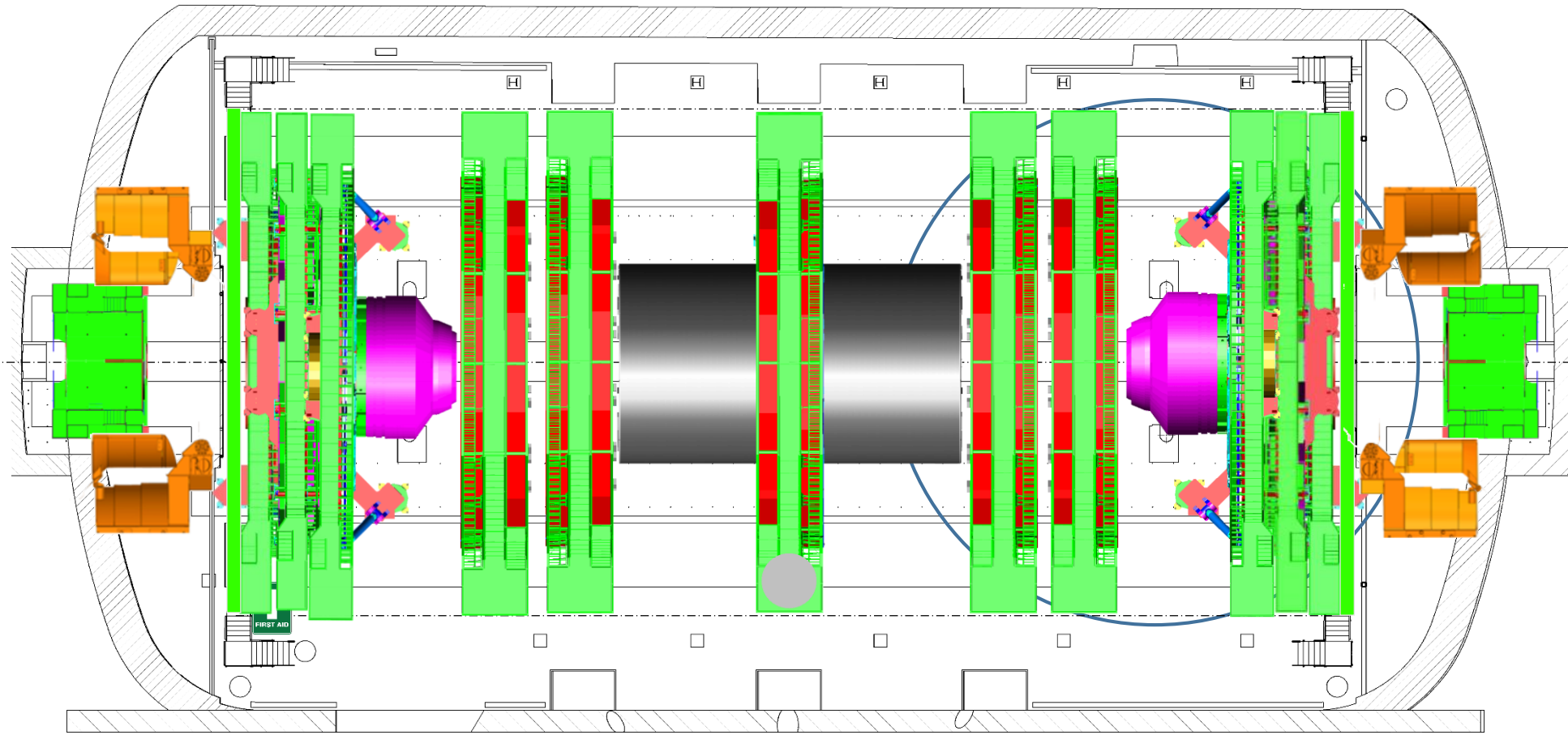
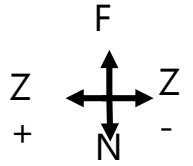

5m



Crane

Cryo.	EL power	Water cool.	Database				
IT	Magnet	C6F14	Gas				
SL. 0	GEM	ECAL	ZEC	DT+ RB	Survey	TE-VSC	SMB
CP. 0	TOTEM	CMX	CSC RE	TK PIX	HCAL	EN Dept	RP

PX56 Plug
OPEN

TX54 Plug
OPEN

Monday

11. February 2019

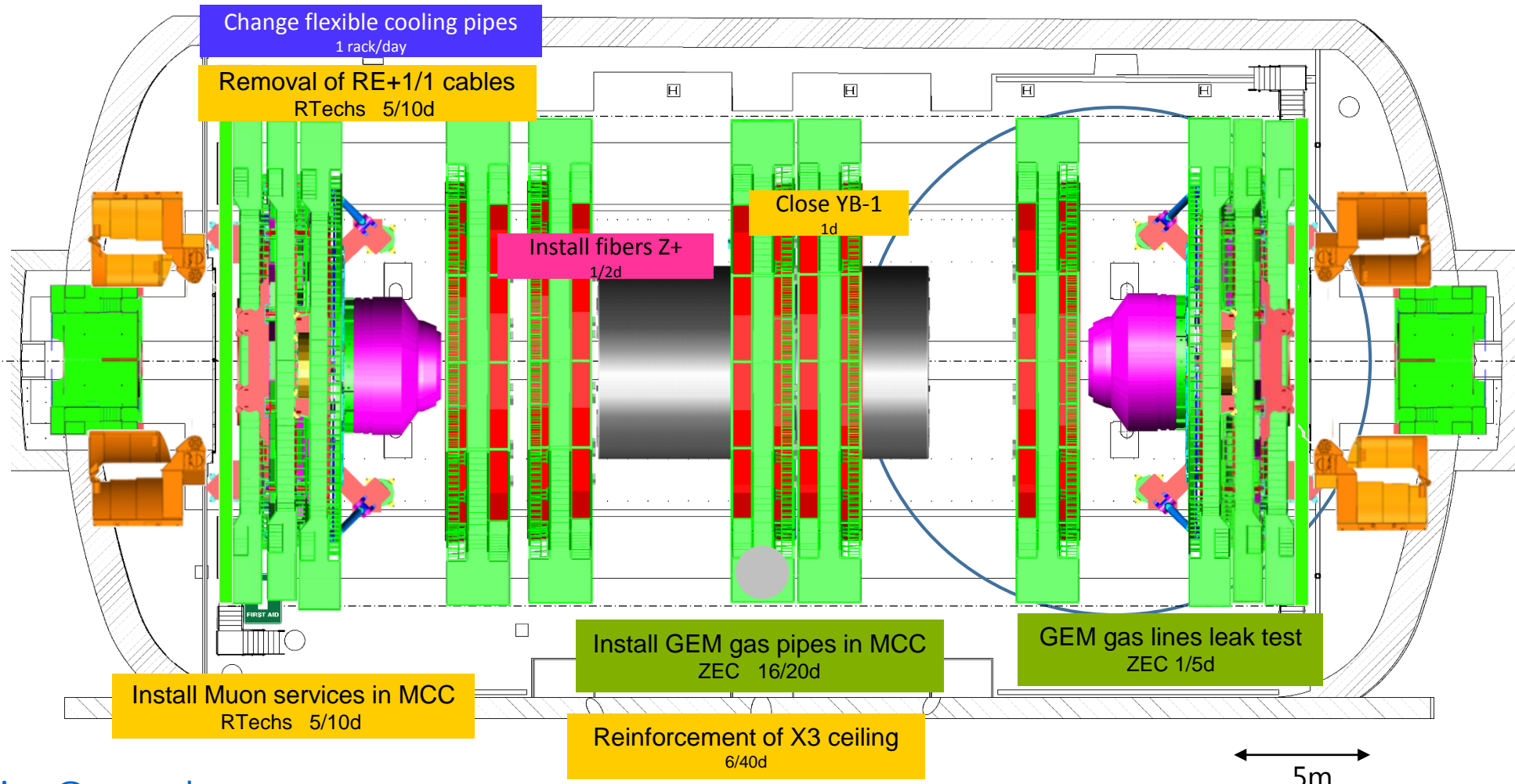
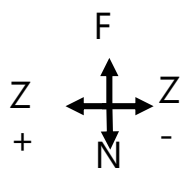



Crane

Cryo.	EL power	Water cool.	Database				
IT	Magnet	C6F14	Gas				
SL. 0	GEM	ECAL	ZEC	DT+ RB	Survey	TE-VSC	SMB
CP. 0	TOTEM	CMX	CSC RE	TK PIX	HCAL	EN Dept	RP

PX56 Plug OPEN
TX54 Plug OPEN

Tuesday
12. February 2019

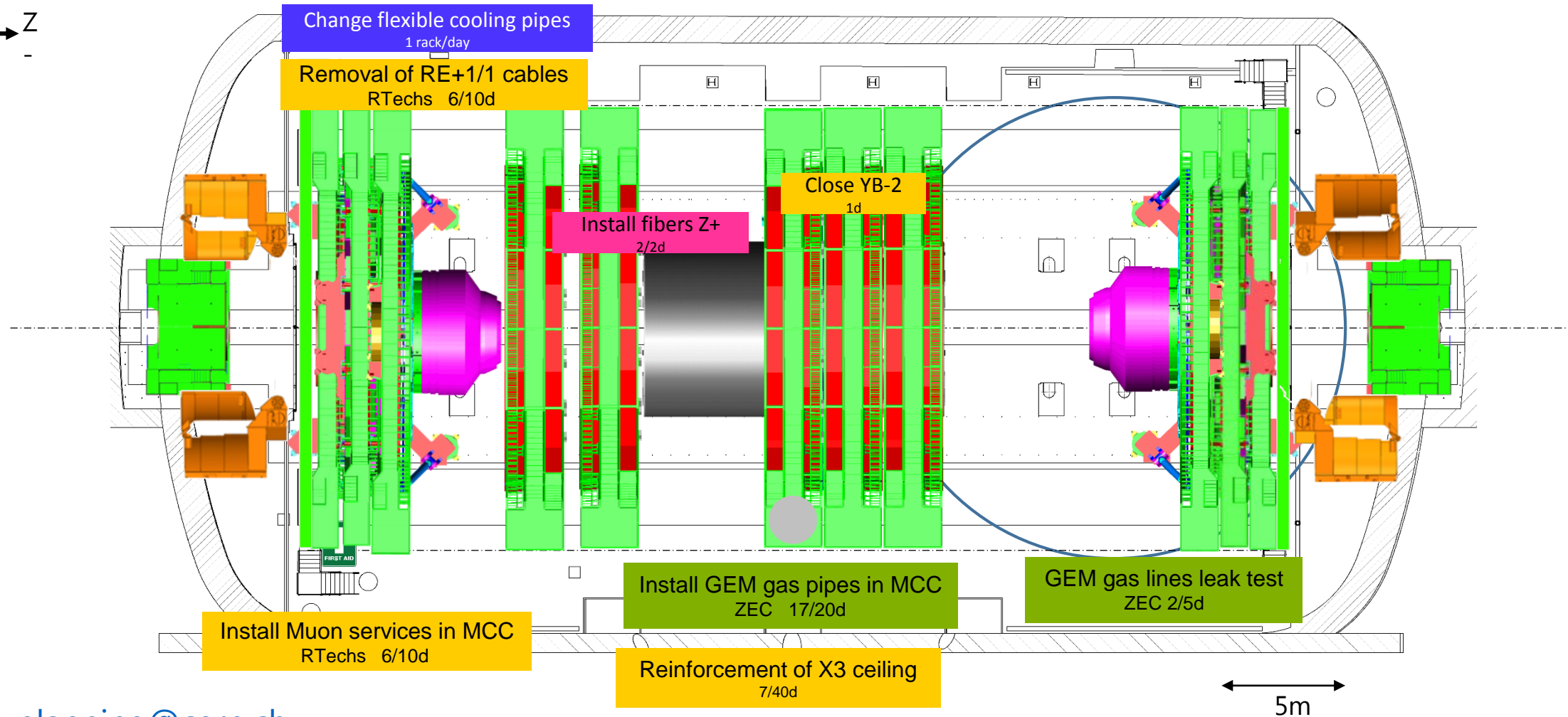
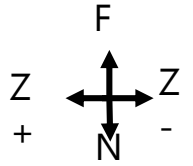



Crane

Cryo.	EL power	Water cool.	Database				
IT	Magnet	C6F14	Gas				
SL. 0	GEM	ECAL	ZEC	DT+ RB	Survey	TE-VSC	SMB
CP. 0	TOTEM	CMX	CSC RE	TK PIX	HCAL	EN Dept	RP

PX56 Plug
OPEN

TX54 Plug
OPEN

Wednesday

13. February 2019

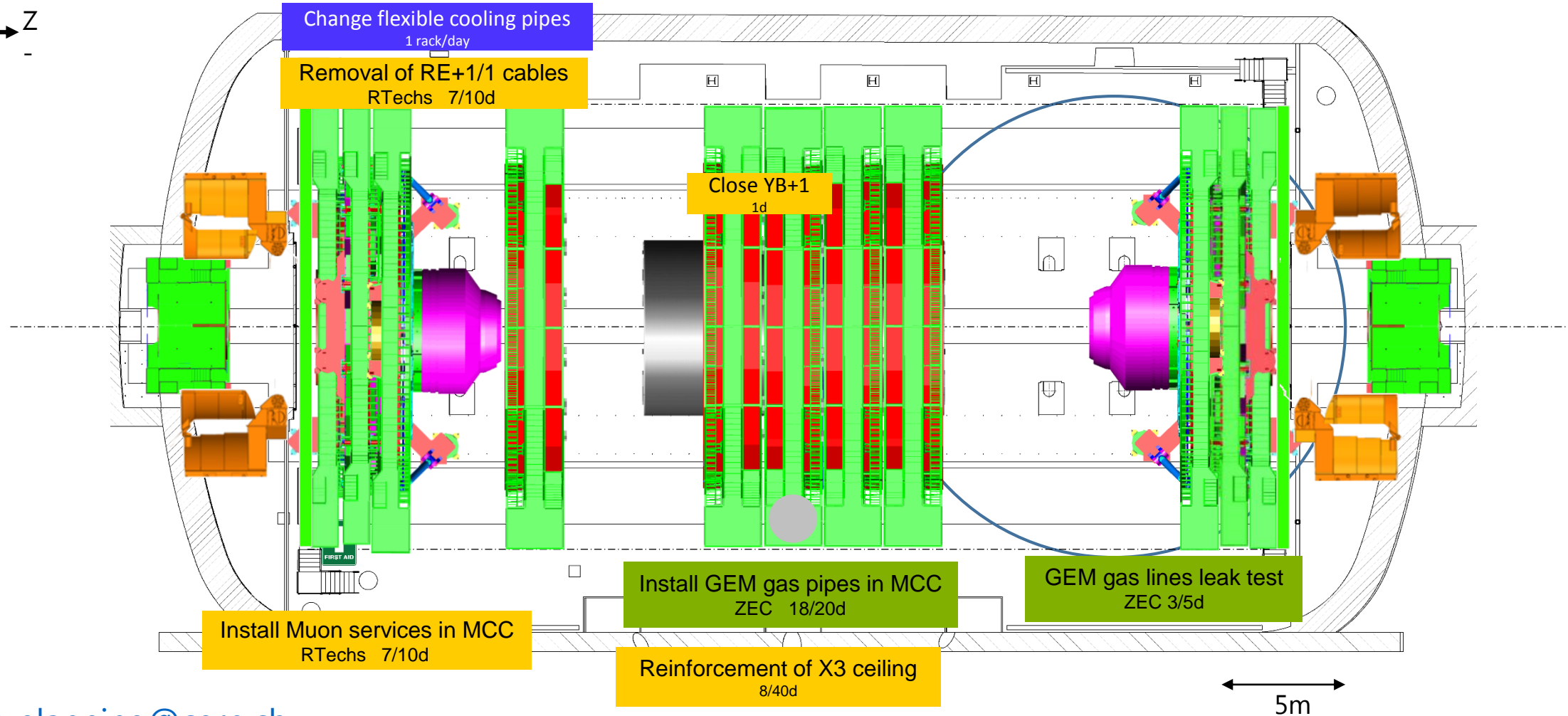
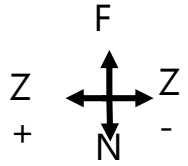



Crane

Cryo.	EL power	Water cool.	Database				
IT	Magnet	C6F14	Gas				
SL. 0	GEM	ECAL	ZEC	DT+ RB	Survey	TE-VSC	SMB
CP. 0	TOTEM	CMX	CSC RE	TK PIX	HCAL	EN Dept	RP

PX56 Plug OPEN
TX54 Plug OPEN

Thursday
14. February 2019

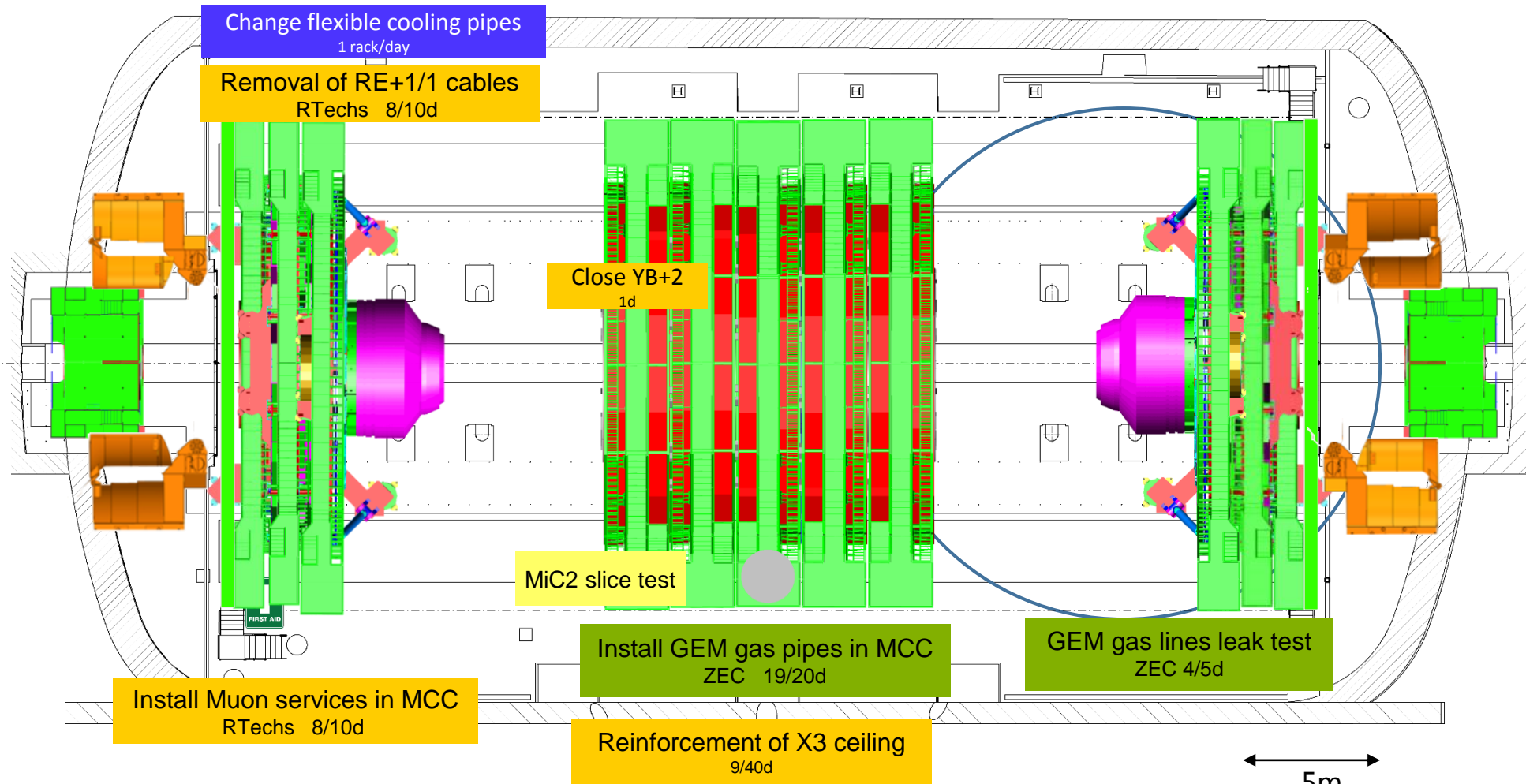



Crane

Cryo.	EL power	Water cool.	Database				
IT	Magnet	C6F14	Gas				
SL. 0	GEM	ECAL	ZEC	DT+ RB	Survey	TE-VSC	SMB
CP. 0	TOTEM	CMX	CSC RE	TK PIX	HCAL	EN Dept	RP

PX56 Plug OPEN
TX54 Plug OPEN

Friday
15. February 2019

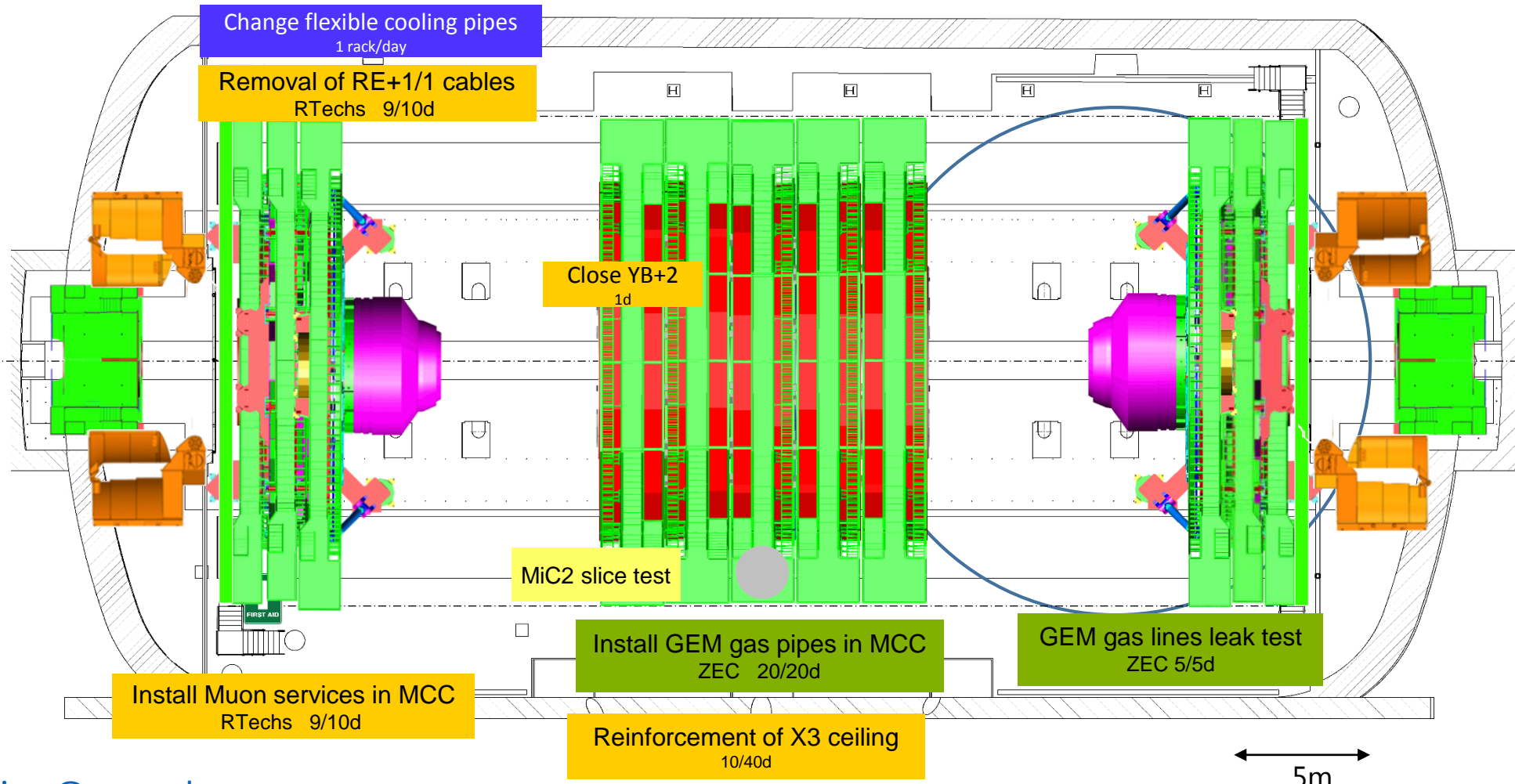
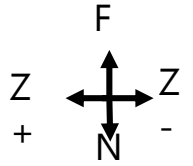



Crane

Cryo.	EL power	Water cool.	Database				
IT	Magnet	C6F14	Gas				
SL. 0	GEM	ECAL	ZEC	DT+ RB	Survey	TE-VSC	SMB
CP. 0	TOTEM	CMX	CSC RE	TK PIX	HCAL	EN Dept	RP

PX56 Plug
OPEN

TX54 Plug
OPEN

Saturday

16. February 2019

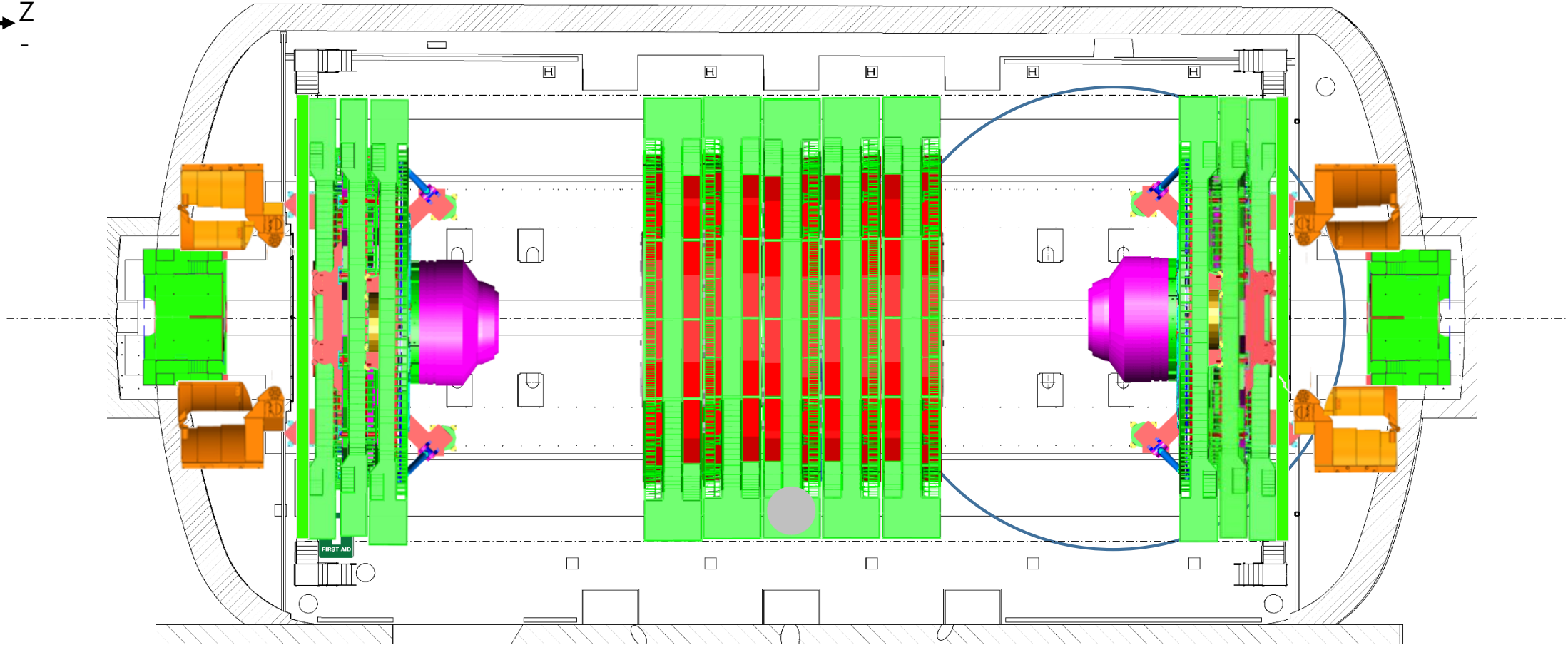
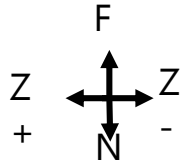

5m



Crane

Cryo.	EL power	Water cool.	Database				
IT	Magnet	C6F14	Gas				
SL. 0	GEM	ECAL	ZEC	DT+ RB	Survey	TE-VSC	SMB
CP. 0	TOTEM	CMX	CSC RE	TK PIX	HCAL	EN Dept	RP

PX56 Plug OPEN
TX54 Plug OPEN

Sunday
17. February 2019

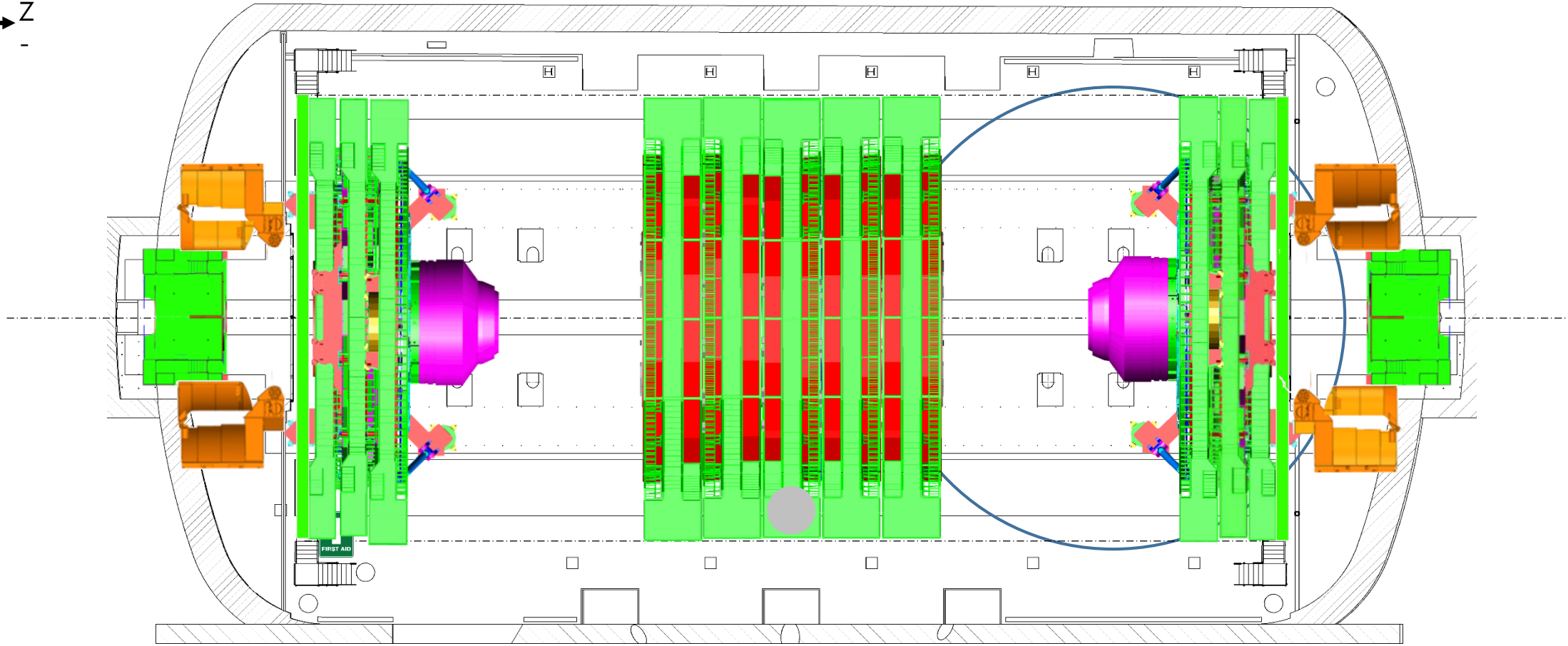
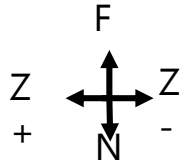

5m



Crane

Cryo.	EL power	Water cool.	Database				
IT	Magnet	C6F14	Gas				
SL. 0	GEM	ECAL	ZEC	DT+ RB	Survey	TE-VSC	SMB
CP. 0	TOTEM	CMX	CSC RE	TK PIX	HCAL	EN Dept	RP

PX56 Plug OPEN

Monday

TX54 Plug OPEN

18. February 2019

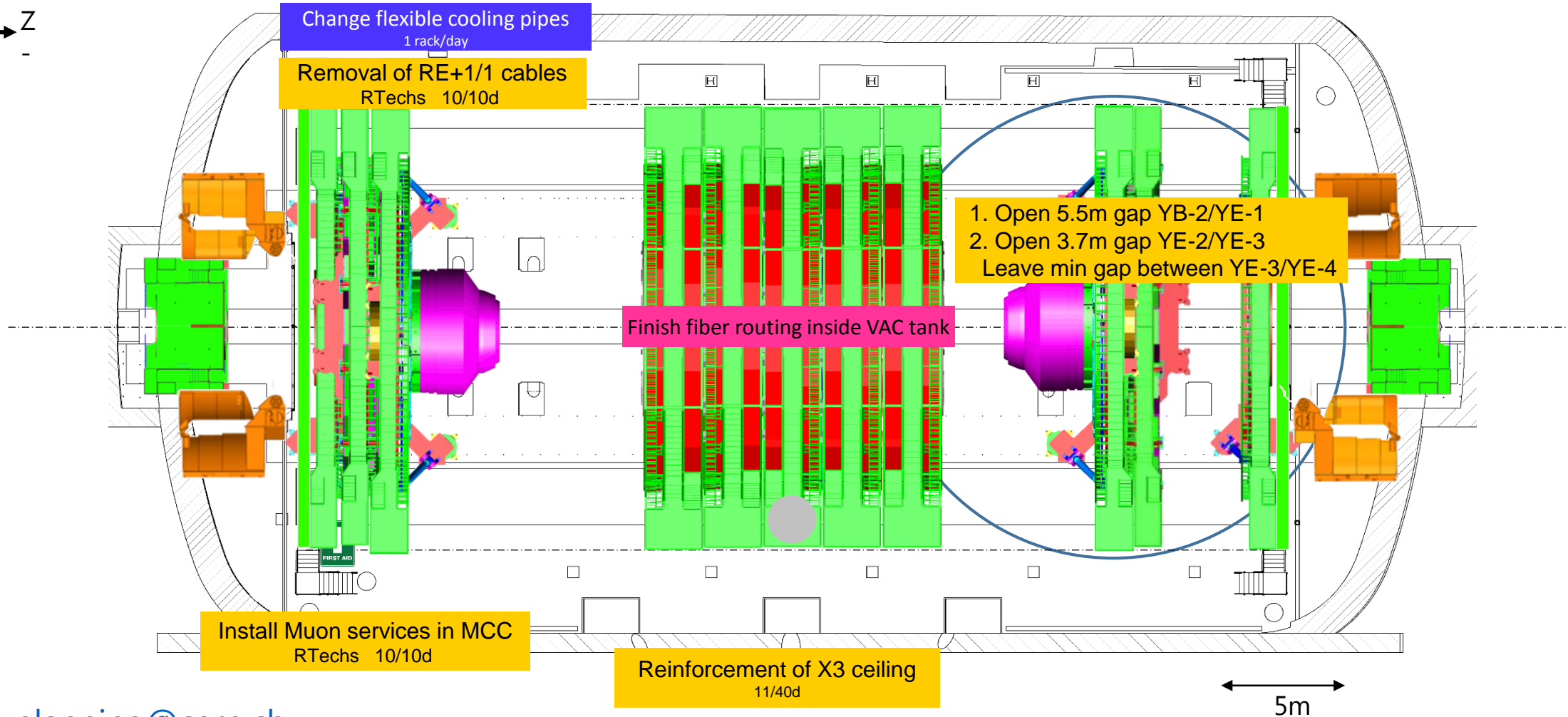
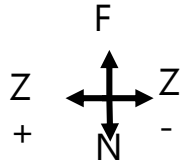



Cryo.	EL power	Water cool.	Database				
IT	Magnet	C6F14	Gas				
SL. 0	GEM	ECAL	ZEC	DT+ RB	Survey	TE-VSC	SMB
CP. 0	TOTEM	CMX	CSC RE	TK PIX	HCAL	EN Dept	RP

PX56 Plug
OPEN

TX54 Plug
OPEN

Tuesday

19. February 2019

Crane

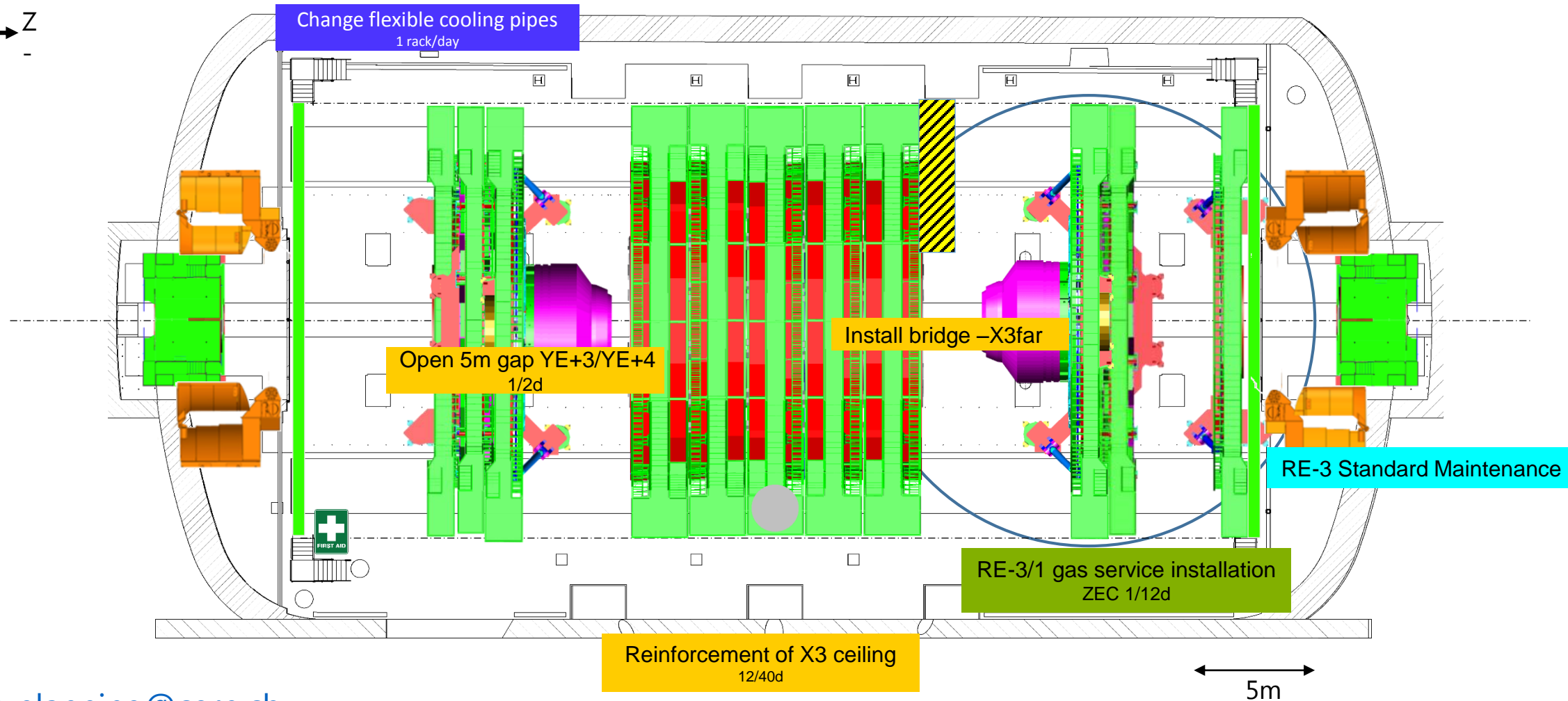



Crane

Cryo.	EL power	Water cool.	Database				
IT	Magnet	C6F14	Gas				
SL. 0	GEM	ECAL	ZEC	DT+ RB	Survey	TE-VSC	SMB
CP. 0	TOTEM	CMX	CSC RE	TK PIX	HCAL	EN Dept	RP

PX56 Plug OPEN
TX54 Plug OPEN

Wednesday
20. February 2019

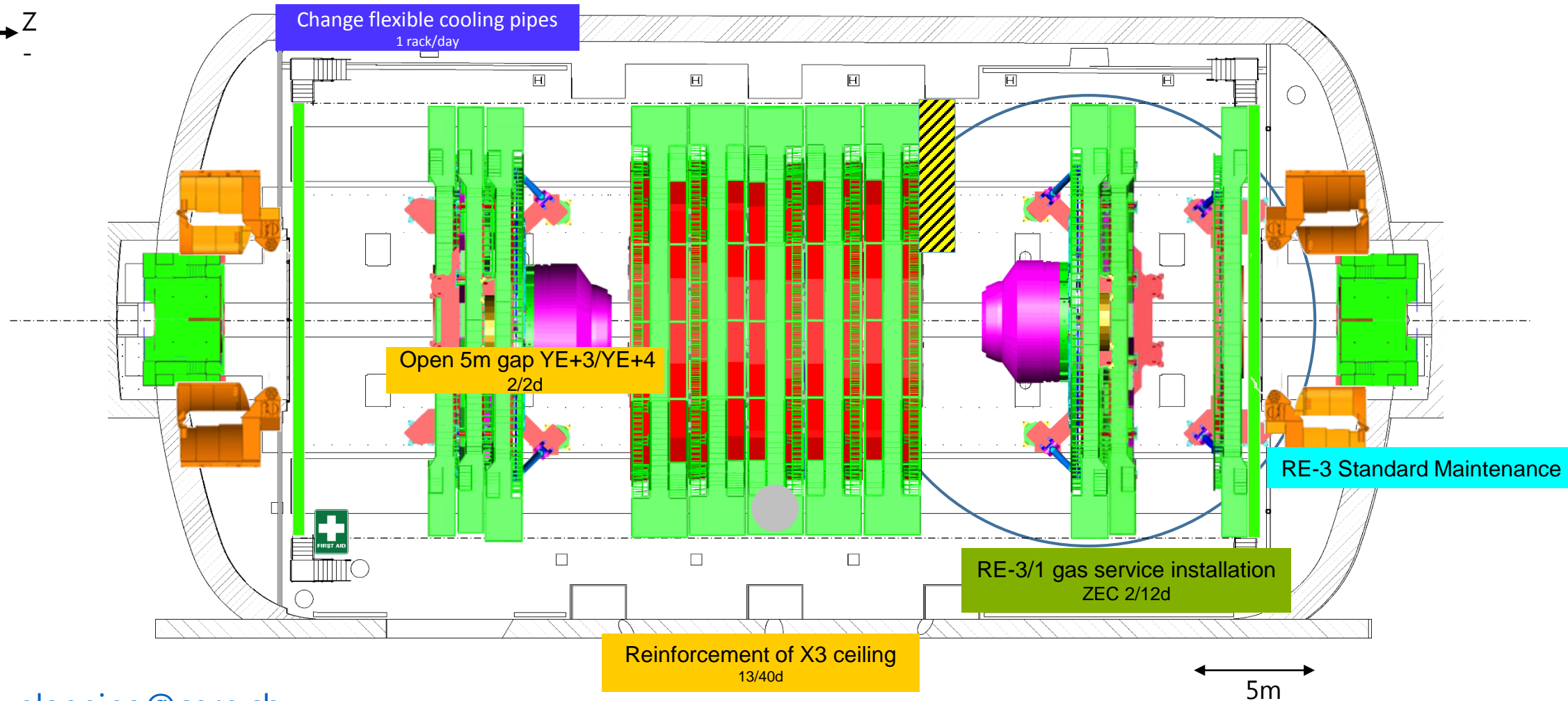
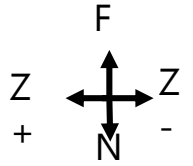



Crane

Cryo.	EL power	Water cool.	Database				
IT	Magnet	C6F14	Gas				
SL. 0	GEM	ECAL	ZEC	DT+ RB	Survey	TE-VSC	SMB
CP. 0	TOTEM	CMX	CSC RE	TK PIX	HCAL	EN Dept	RP

PX56 Plug OPEN
TX54 Plug OPEN

Thursday
21. February 2019

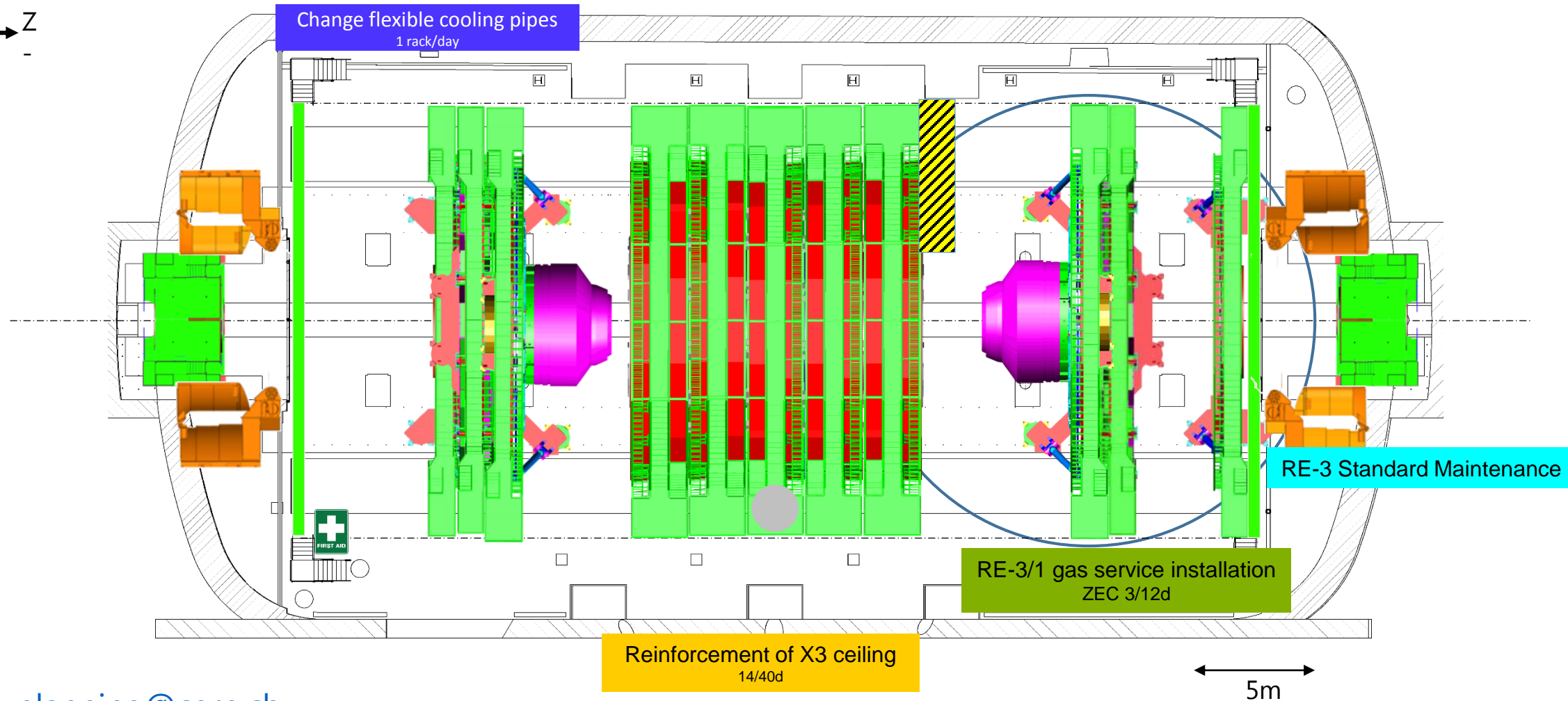
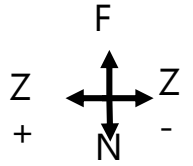



Cryo.	EL power	Water cool.	Database				
IT	Magnet	C6F14	Gas				
SL. 0	GEM	ECAL	ZEC	DT+ RB	Survey	TE-VSC	SMB
CP. 0	TOTEM	CMX	CSC RE	TK PIX	HCAL	EN Dept	RP

PX56 Plug
OPEN

TX54 Plug
OPEN

Friday

22. February 2019

Crane

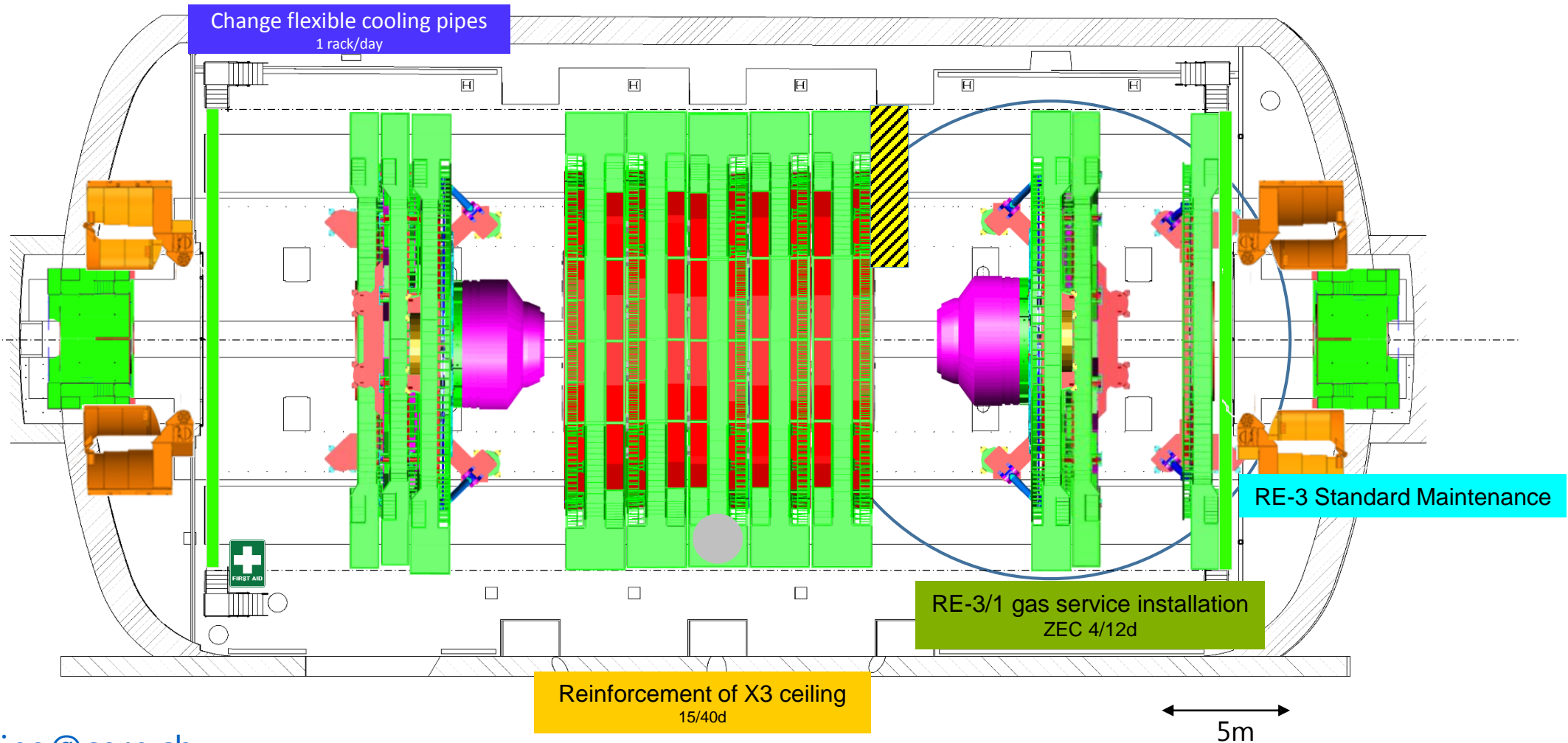
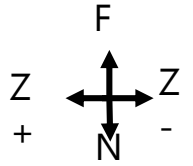



Crane

Cryo.	EL power	Water cool.	Database				
IT	Magnet	C6F14	Gas				
SL. 0	GEM	ECAL	ZEC	DT+ RB	Survey	TE-VSC	SMB
CP. 0	TOTEM	CMX	CSC RE	TK PIX	HCAL	EN Dept	RP

PX56 Plug
OPEN

TX54 Plug
OPEN

Saturday

23. February 2019

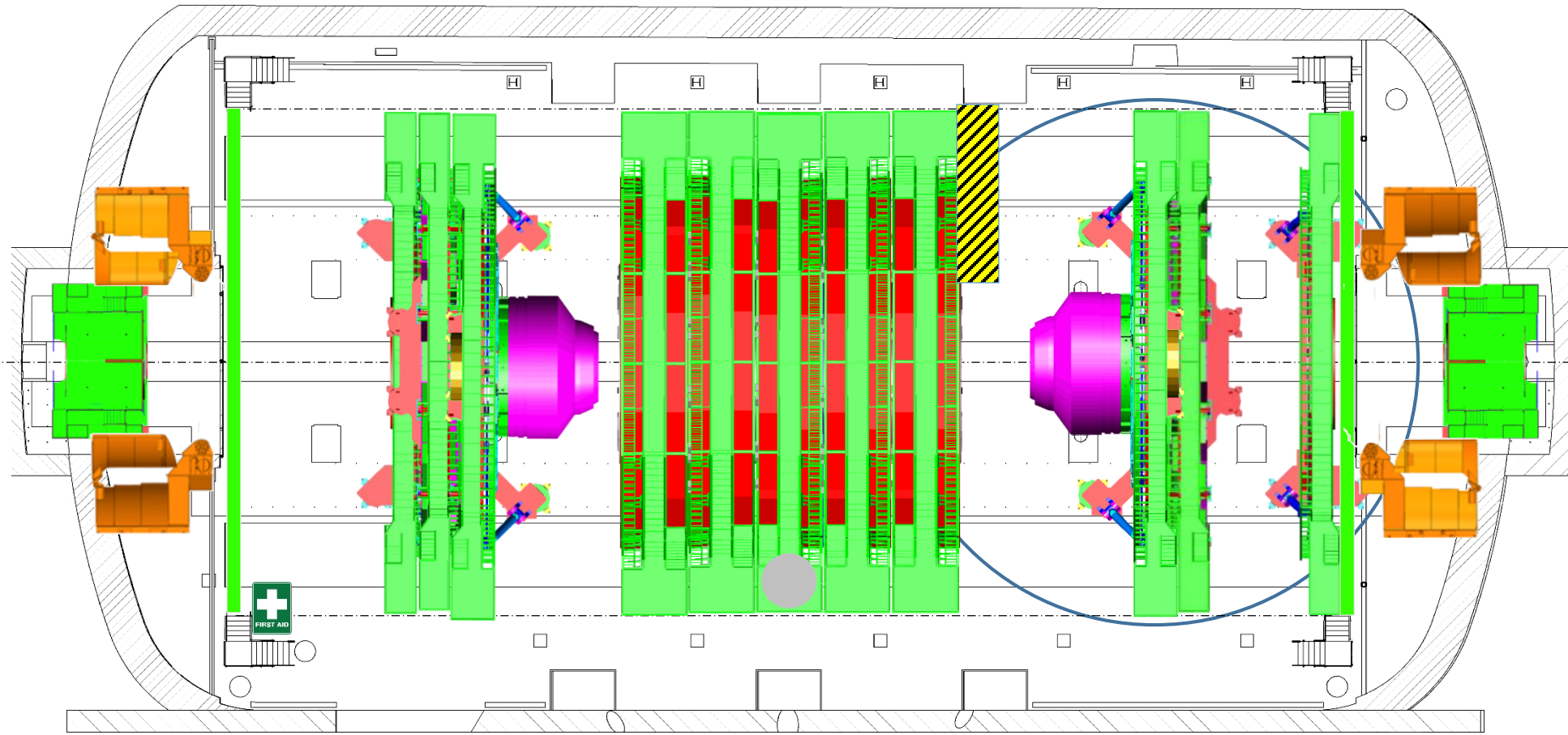
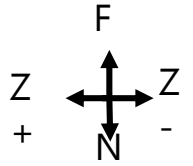

5m



Crane

Cryo.	EL power	Water cool.	Database				
IT	Magnet	C6F14	Gas				
SL. 0	GEM	ECAL	ZEC	DT+ RB	Survey	TE-VSC	SMB
CP. 0	TOTEM	CMX	CSC RE	TK PIX	HCAL	EN Dept	RP

PX56 Plug OPEN
TX54 Plug OPEN

Sunday
24. February 2019

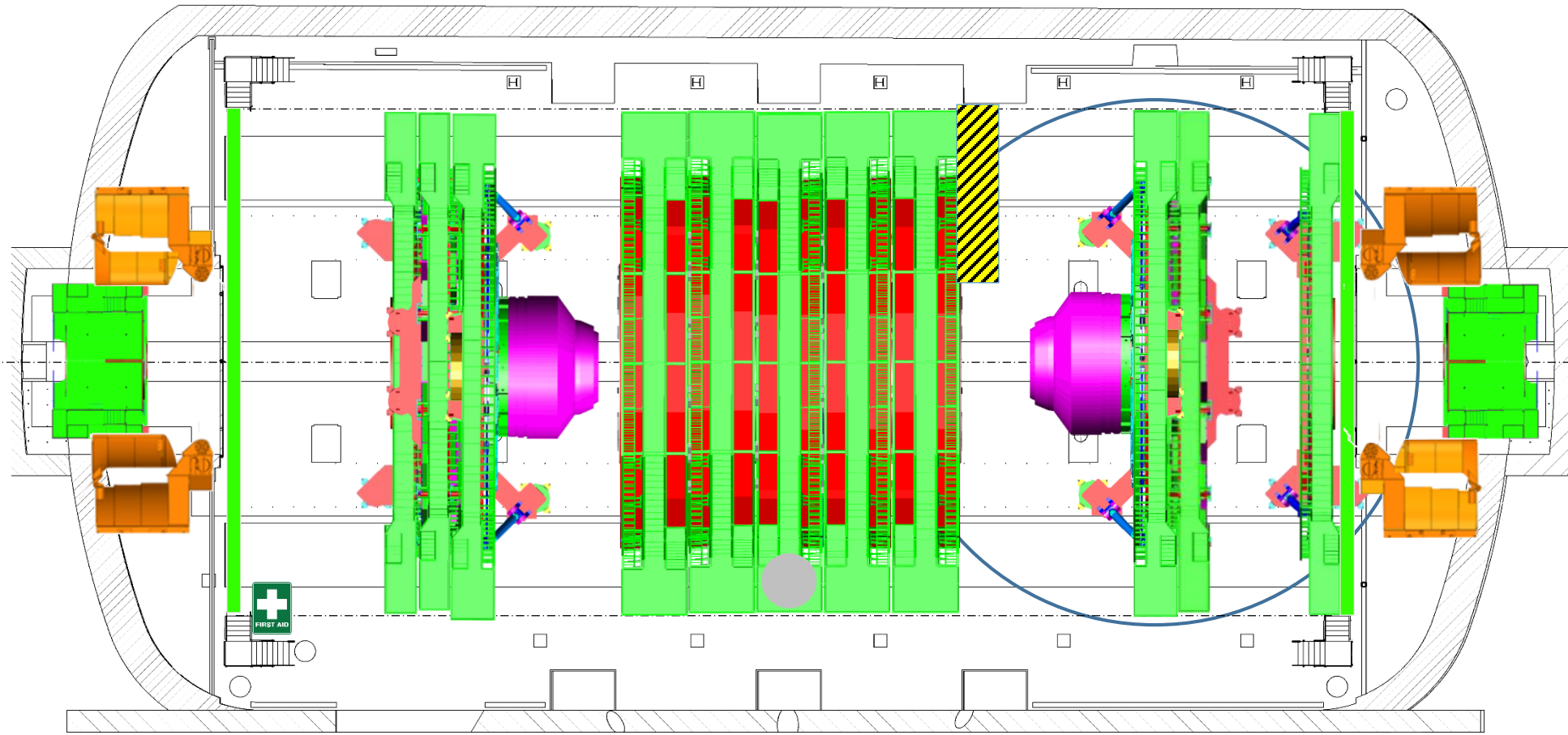
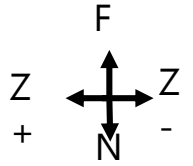

5m



Crane

Cryo.	EL power	Water cool.	Database				
IT	Magnet	C6F14	Gas				
SL. 0	GEM	ECAL	ZEC	DT+ RB	Survey	TE-VSC	SMB
CP. 0	TOTEM	CMX	CSC RE	TK PIX	HCAL	EN Dept	RP

PX56 Plug OPEN

Monday

TX54 Plug OPEN

25. February 2019

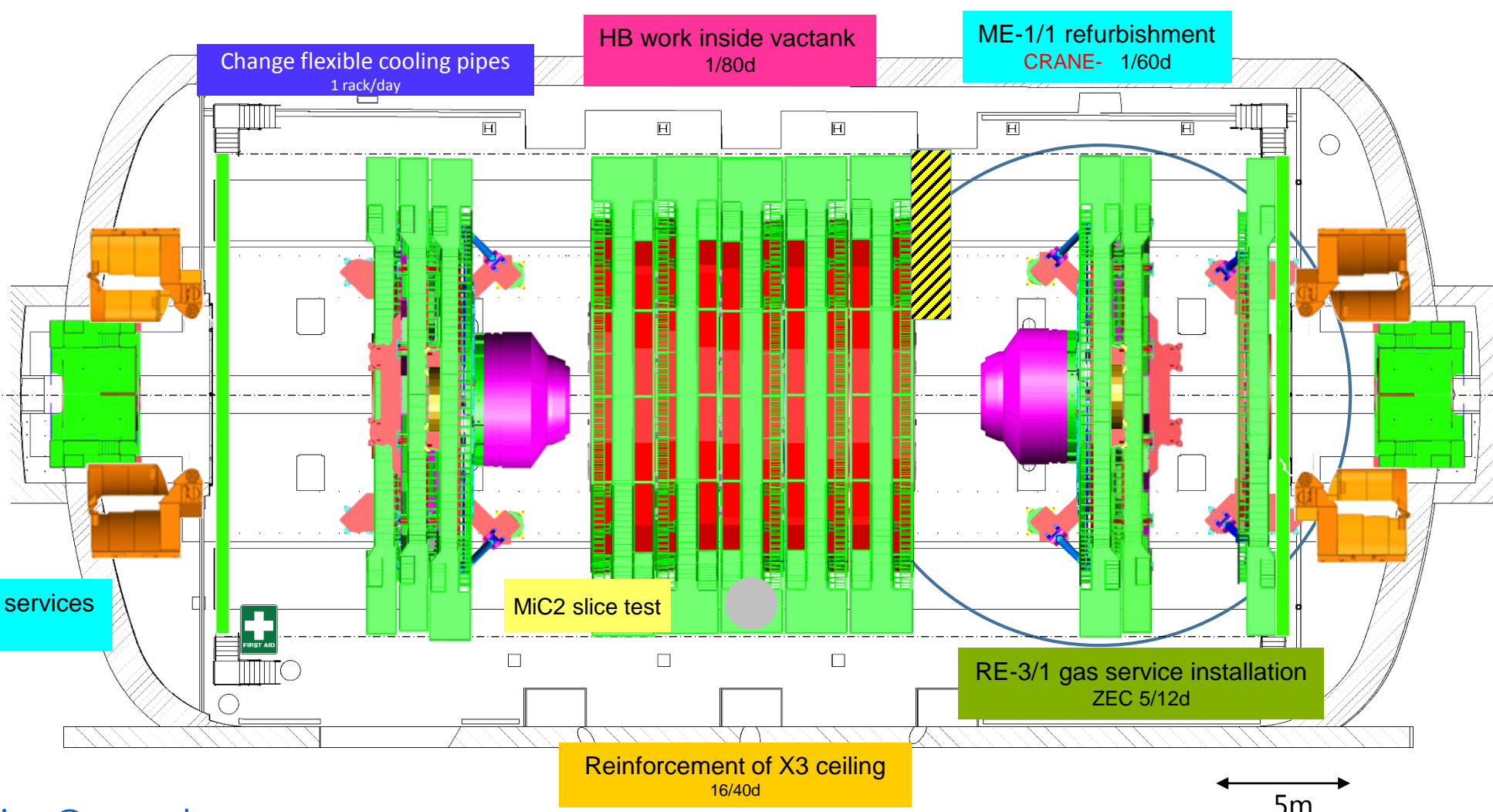
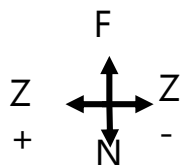

5m



Crane

Cryo.	EL power	Water cool.	Database				
IT	Magnet	C6F14	Gas				
SL. 0	GEM	ECAL	ZEC	DT+ RB	Survey	TE-VSC	SMB
CP. 0	TOTEM	CMX	CSC RE	TK PIX	HCAL	EN Dept	RP

PX56 Plug OPEN

Tuesday

TX54 Plug OPEN

26. February 2019

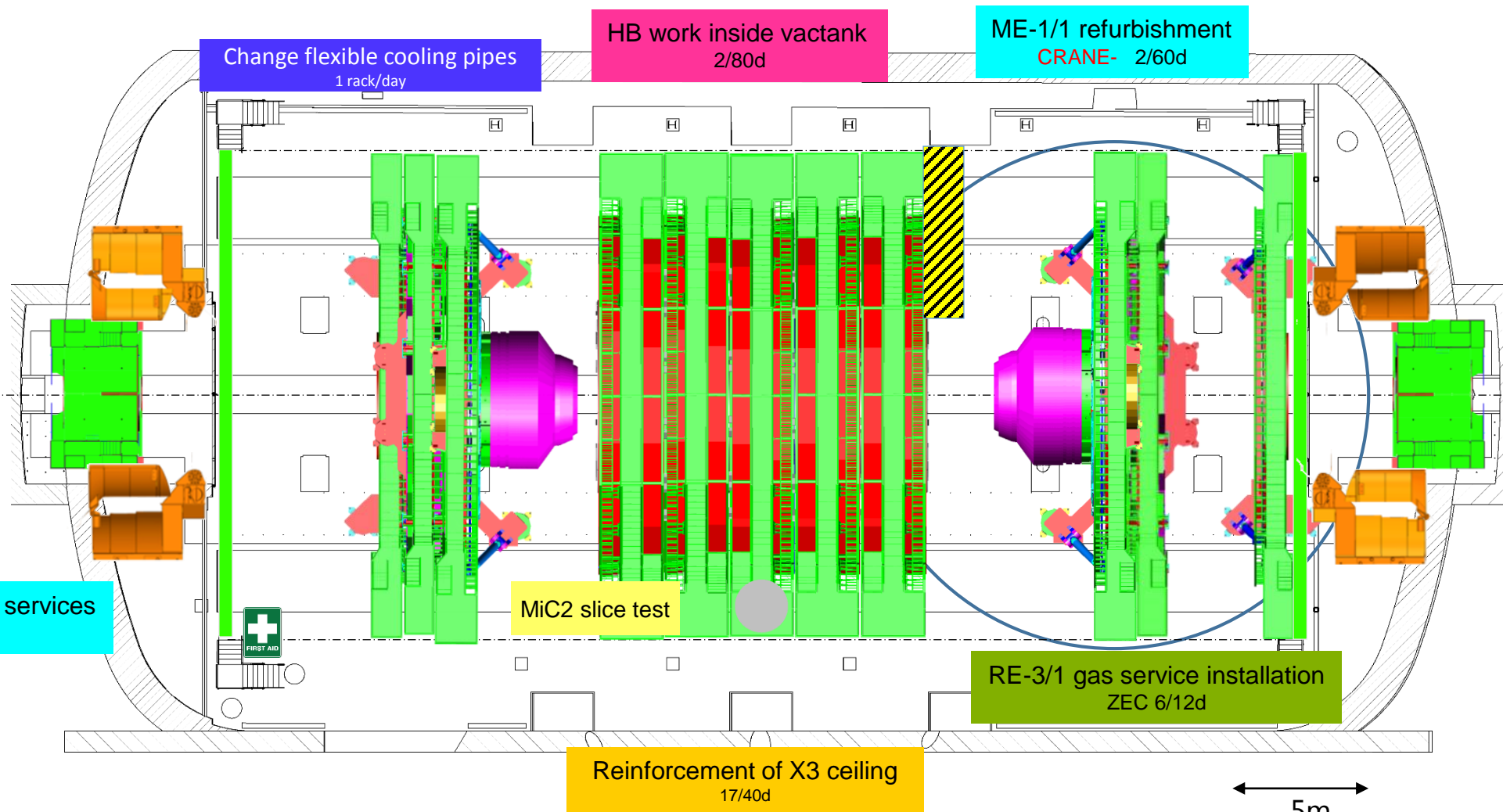
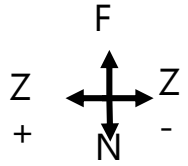

Change flexible cooling pipes
1 rack/day

HB work inside vactank
2/80d

ME-1/1 refurbishment
CRANE- 2/60d

Disconnect RE+4/2 services
2/6d

MiC2 slice test

RE-3/1 gas service installation
ZEC 6/12d

Reinforcement of X3 ceiling
17/40d

5m



Crane

Cryo.	EL power	Water cool.	Database				
IT	Magnet	C6F14	Gas				
SL. 0	GEM	ECAL	ZEC	DT+ RB	Survey	TE-VSC	SMB
CP. 0	TOTEM	CMX	CSC RE	TK PIX	HCAL	EN Dept	RP

PX56 Plug OPEN

Wednesday

TX54 Plug OPEN

27. February 2019

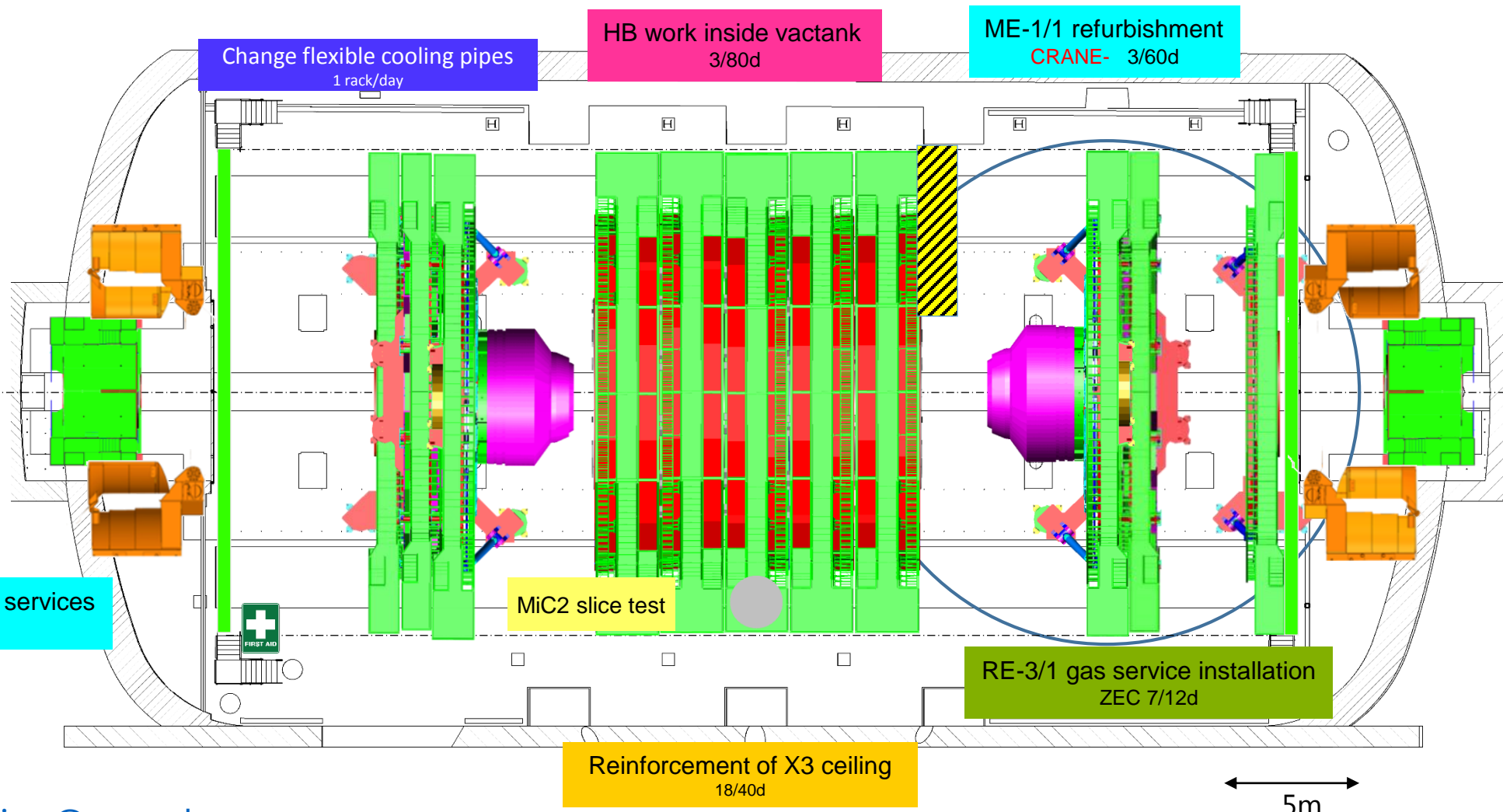
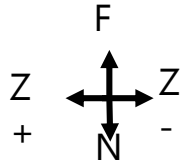

5m



Crane

Cryo.	EL power	Water cool.	Database				
IT	Magnet	C6F14	Gas				
SL. 0	GEM	ECAL	ZEC	DT+ RB	Survey	TE-VSC	SMB
CP. 0	TOTEM	CMX	CSC RE	TK PIX	HCAL	EN Dept	RP

PX56 Plug OPEN

Thursday

TX54 Plug OPEN

28. February 2019

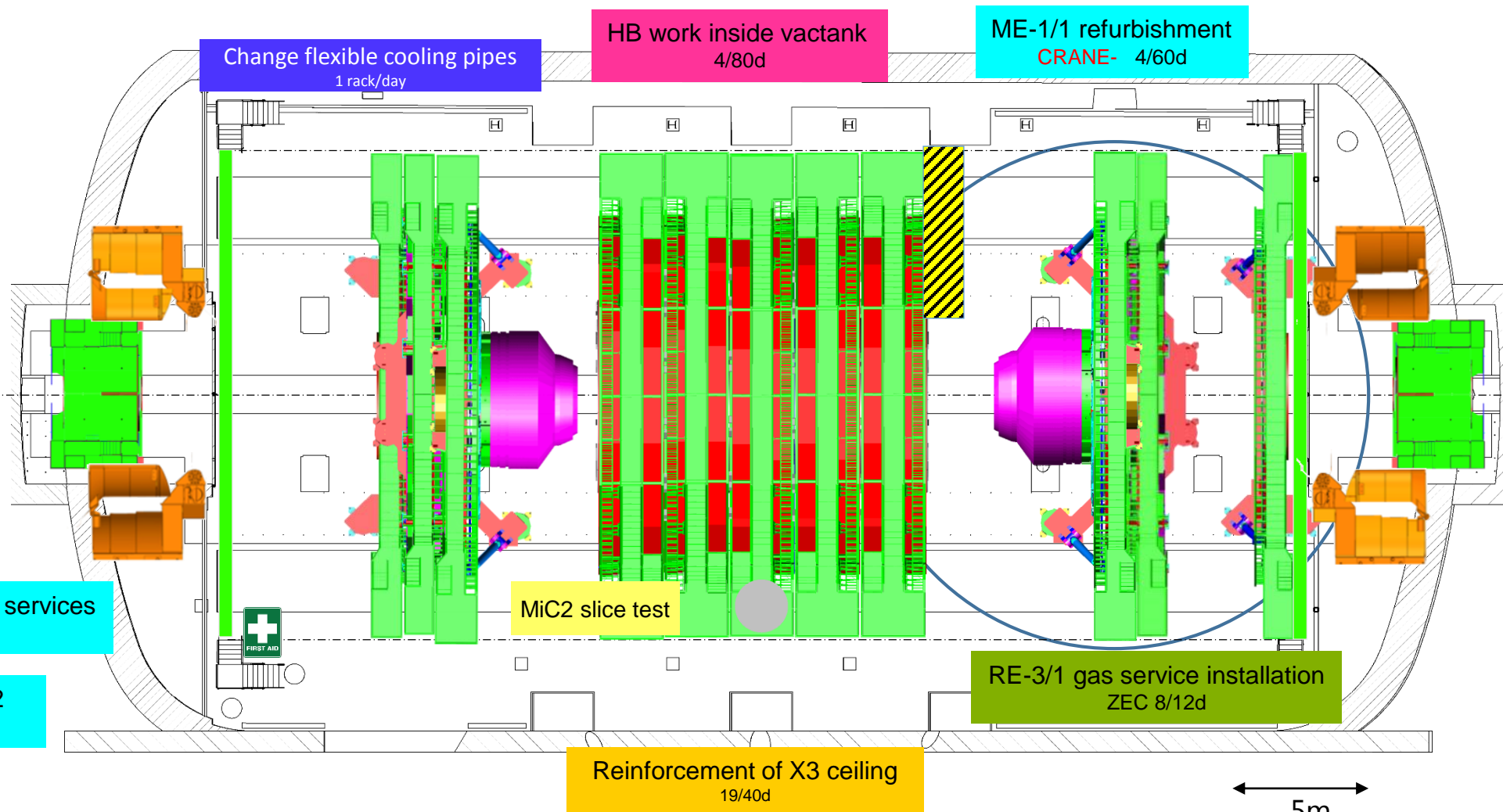
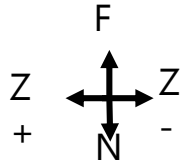

5m



Crane

Cryo.	EL power	Water cool.	Database				
IT	Magnet	C6F14	Gas				
SL. 0	GEM	ECAL	ZEC	DT+ RB	Survey	TE-VSC	SMB
CP. 0	TOTEM	CMX	CSC RE	TK PIX	HCAL	EN Dept	RP

PX56 Plug OPEN
TX54 Plug OPEN

Friday
01. March 2019

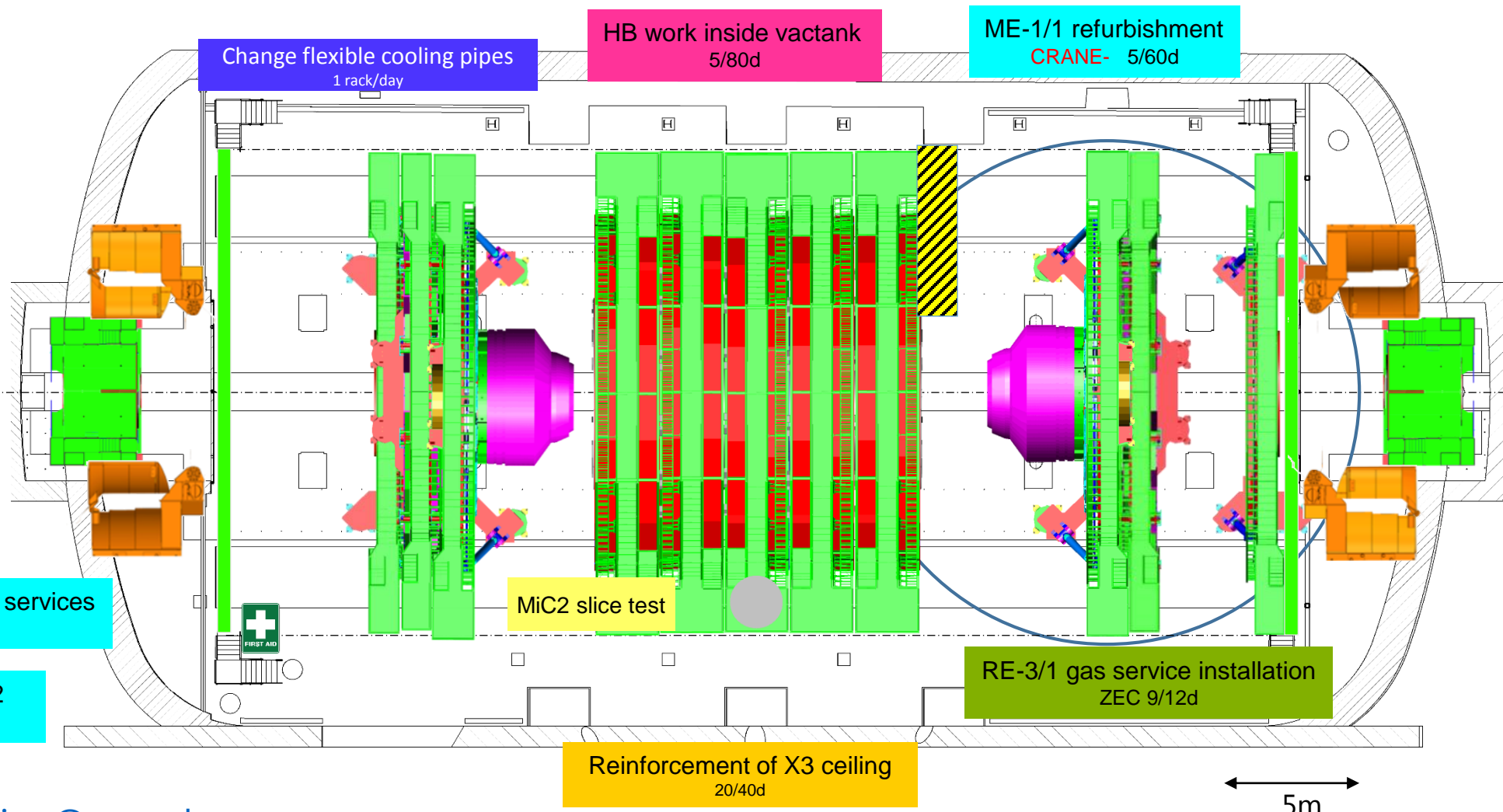



Crane

Cryo.	EL power	Water cool.	Database				
IT	Magnet	C6F14	Gas				
SL. 0	GEM	ECAL	ZEC	DT+ RB	Survey	TE-VSC	SMB
CP. 0	TOTEM	CMX	CSC RE	TK PIX	HCAL	EN Dept	RP

PX56 Plug OPEN
TX54 Plug OPEN

Saturday
02. March 2019

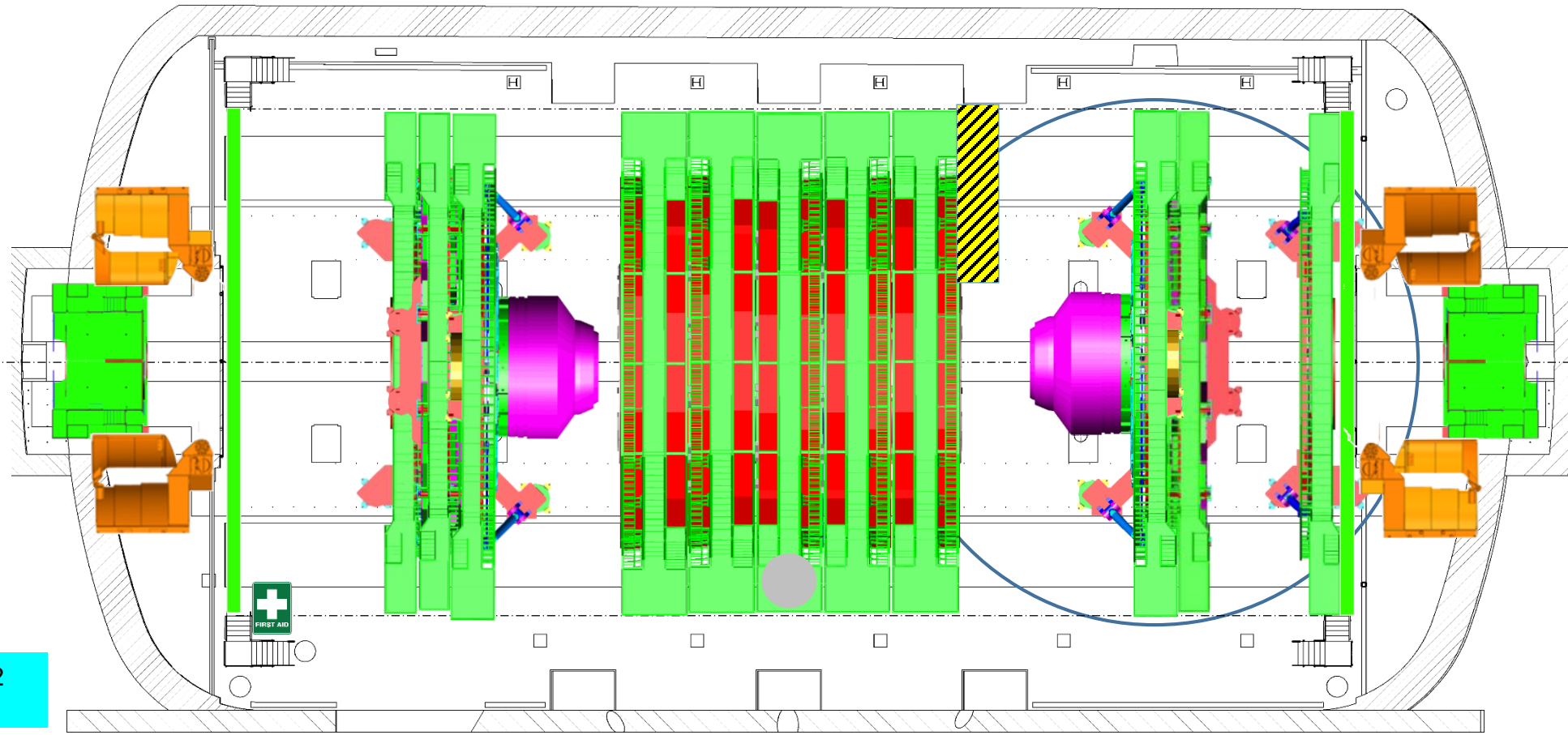
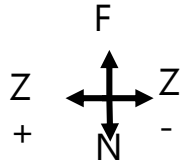

Dismount RE+4/2
CRANE+ 3/6d

5m



Crane

Cryo.	EL power	Water cool.	Database				
IT	Magnet	C6F14	Gas				
SL. 0	GEM	ECAL	ZEC	DT+ RB	Survey	TE-VSC	SMB
CP. 0	TOTEM	CMX	CSC RE	TK PIX	HCAL	EN Dept	RP

PX56 Plug OPEN

Sunday

TX54 Plug OPEN

03. March 2019

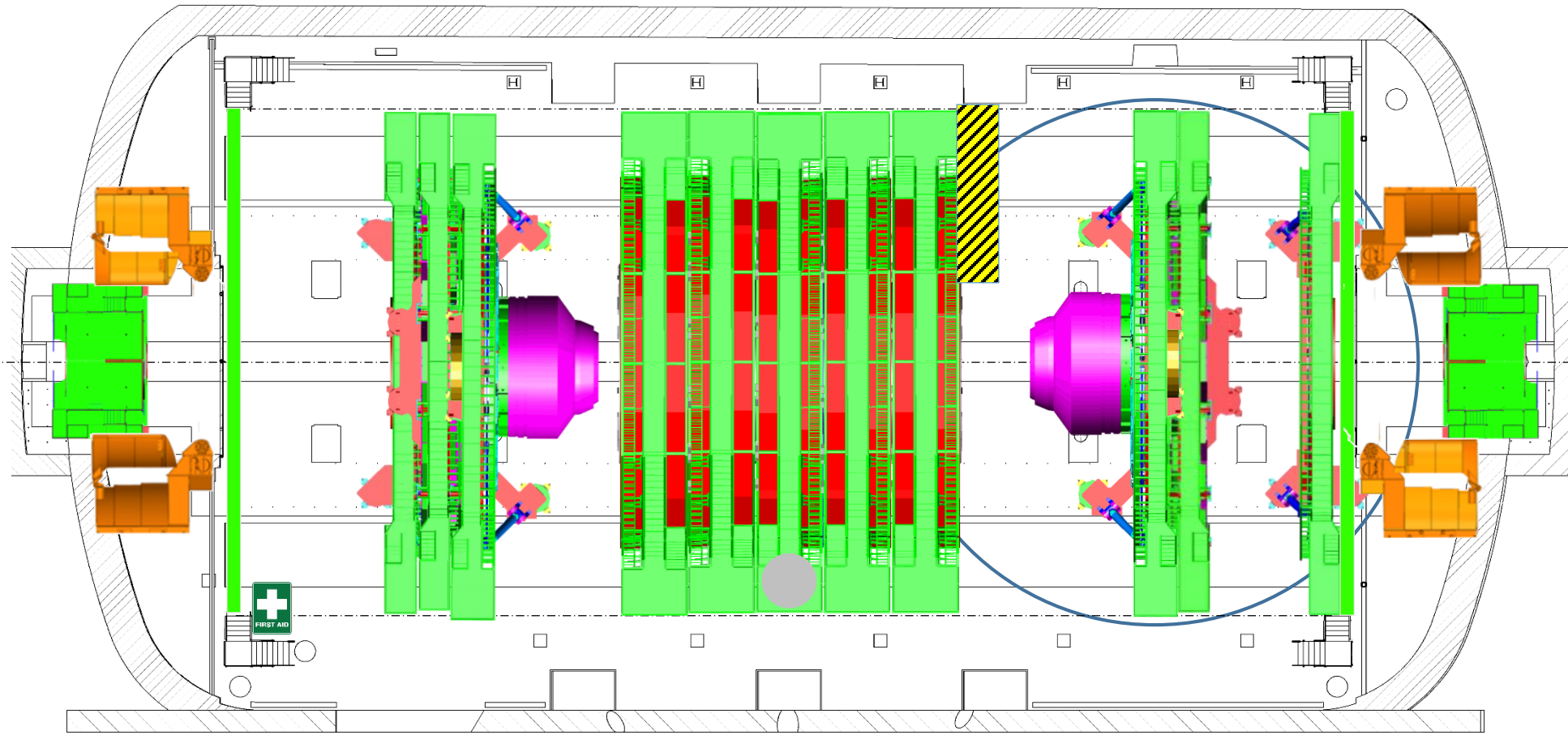
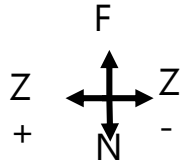

5m



Crane

Cryo.	EL power	Water cool.	Database				
IT	Magnet	C6F14	Gas				
SL. 0	GEM	ECAL	ZEC	DT+ RB	Survey	TE-VSC	SMB
CP. 0	TOTEM	CMX	CSC RE	TK PIX	HCAL	EN Dept	RP

PX56 Plug OPEN
TX54 Plug OPEN

Monday
04. March 2019

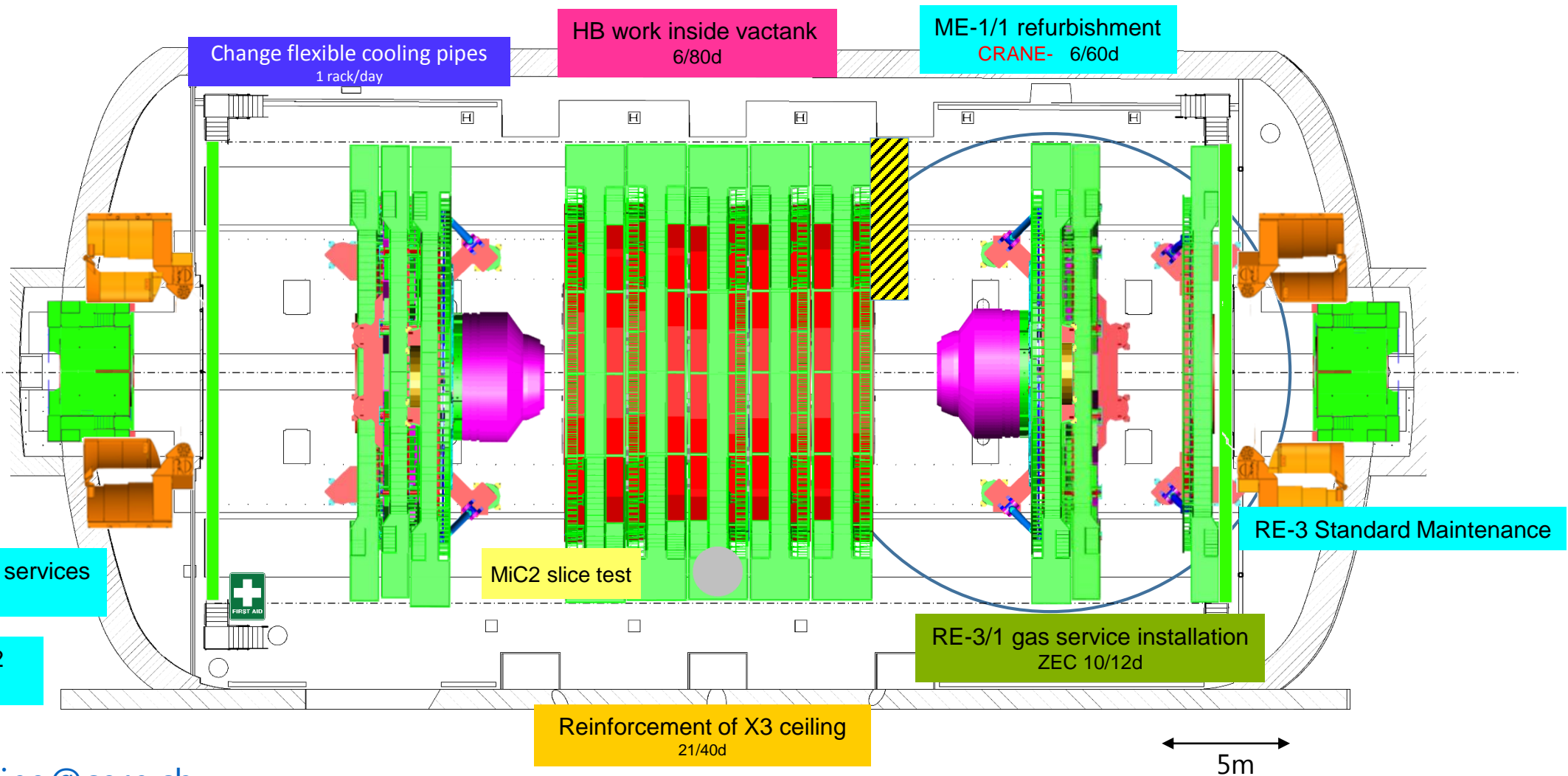
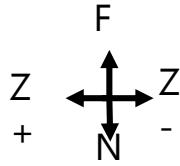



Crane

Cryo.	EL power	Water cool.	Database				
IT	Magnet	C6F14	Gas				
SL. 0	GEM	ECAL	ZEC	DT+ RB	Survey	TE-VSC	SMB
CP. 0	TOTEM	CMX	CSC RE	TK PIX	HCAL	EN Dept	RP

PX56 Plug
OPEN

TX54 Plug
OPEN

Tuesday

05. March 2019

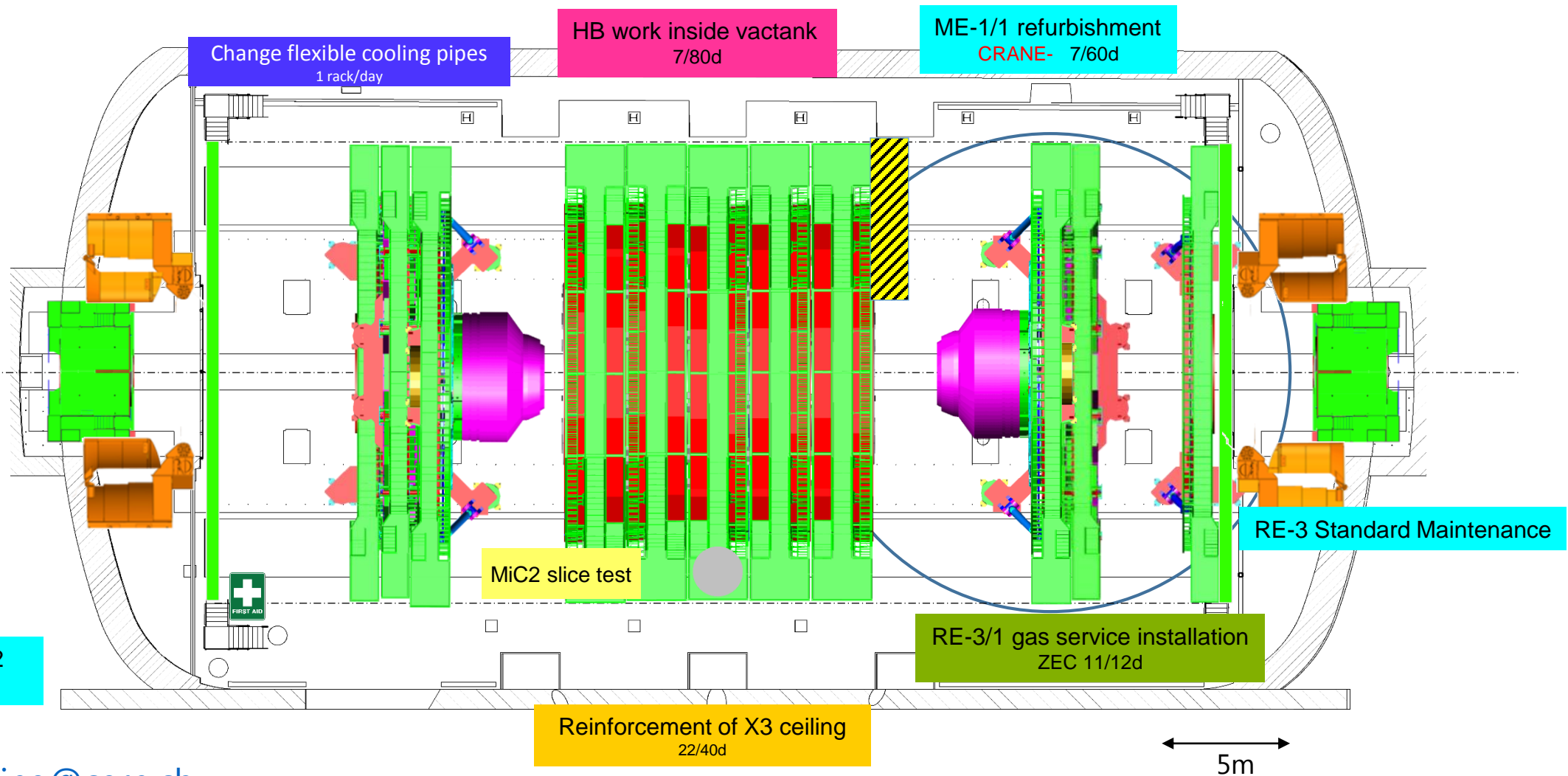
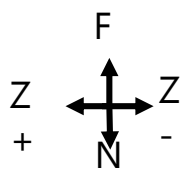

Dismount RE+4/2
CRANE+ 5/6d

Reinforcement of X3 ceiling
22/40d

5m



Crane

Cryo.	EL power	Water cool.	Database				
IT	Magnet	C6F14	Gas				
SL. 0	GEM	ECAL	ZEC	DT+ RB	Survey	TE-VSC	SMB
CP. 0	TOTEM	CMX	CSC RE	TK PIX	HCAL	EN Dept	RP

PX56 Plug OPEN
TX54 Plug OPEN

Wednesday
06. March 2019

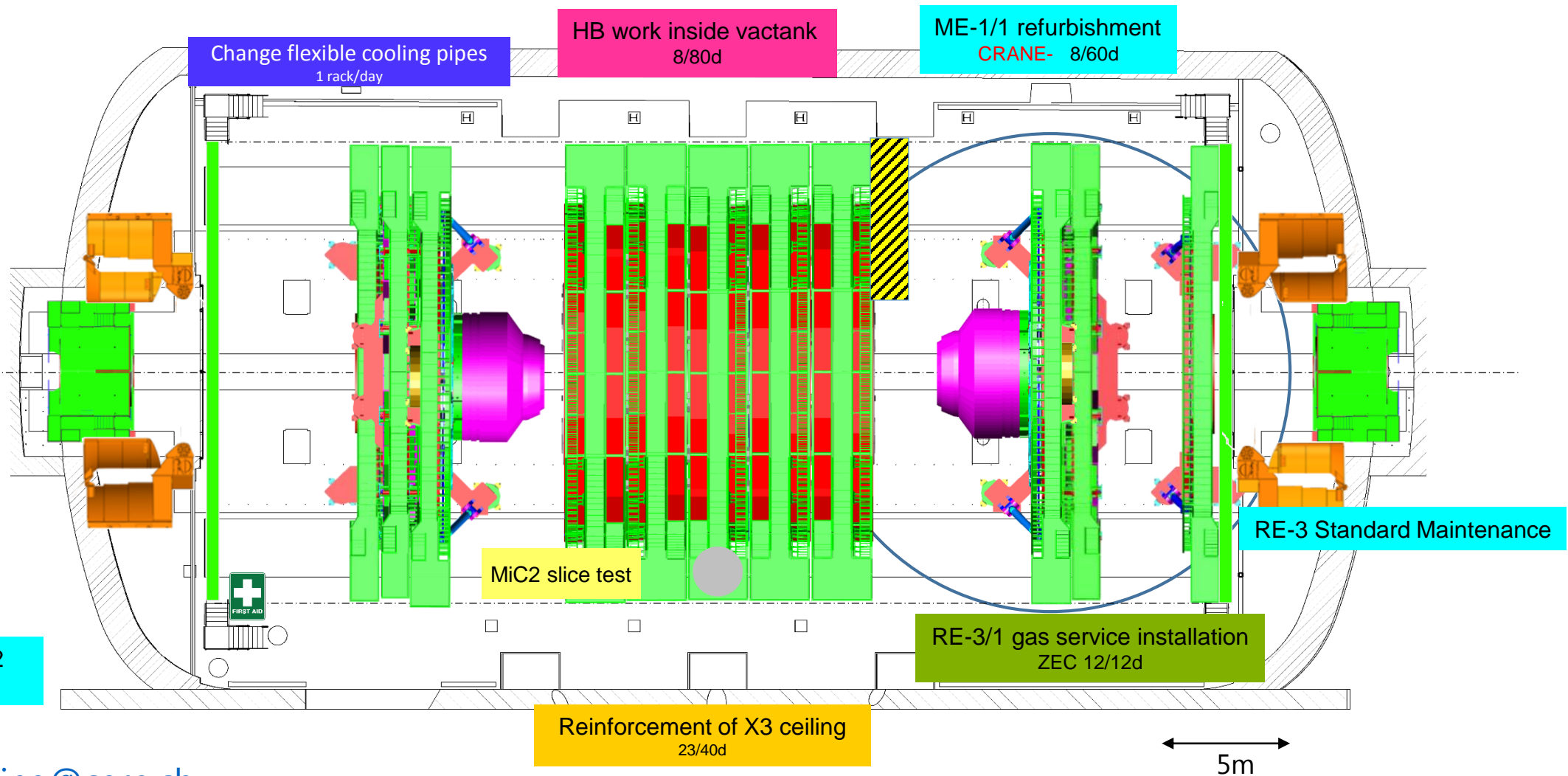
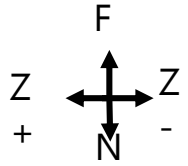

Dismount RE+4/2
CRANE+ 6/6d



Crane

Cryo.	EL power	Water cool.	Database				
IT	Magnet	C6F14	Gas				
SL. 0	GEM	ECAL	ZEC	DT+ RB	Survey	TE-VSC	SMB
CP. 0	TOTEM	CMX	CSC RE	TK PIX	HCAL	EN Dept	RP

PX56 Plug OPEN

Thursday

TX54 Plug OPEN

07. March 2019

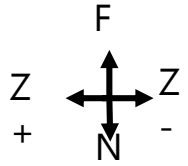

ME+4/1 Flow restrictor replacement (ZEC) 1/2d

Change flexible cooling pipes 1 rack/day

HB work inside vactank 9/80d

ME-1/1 refurbishment CRANE- 9/60d

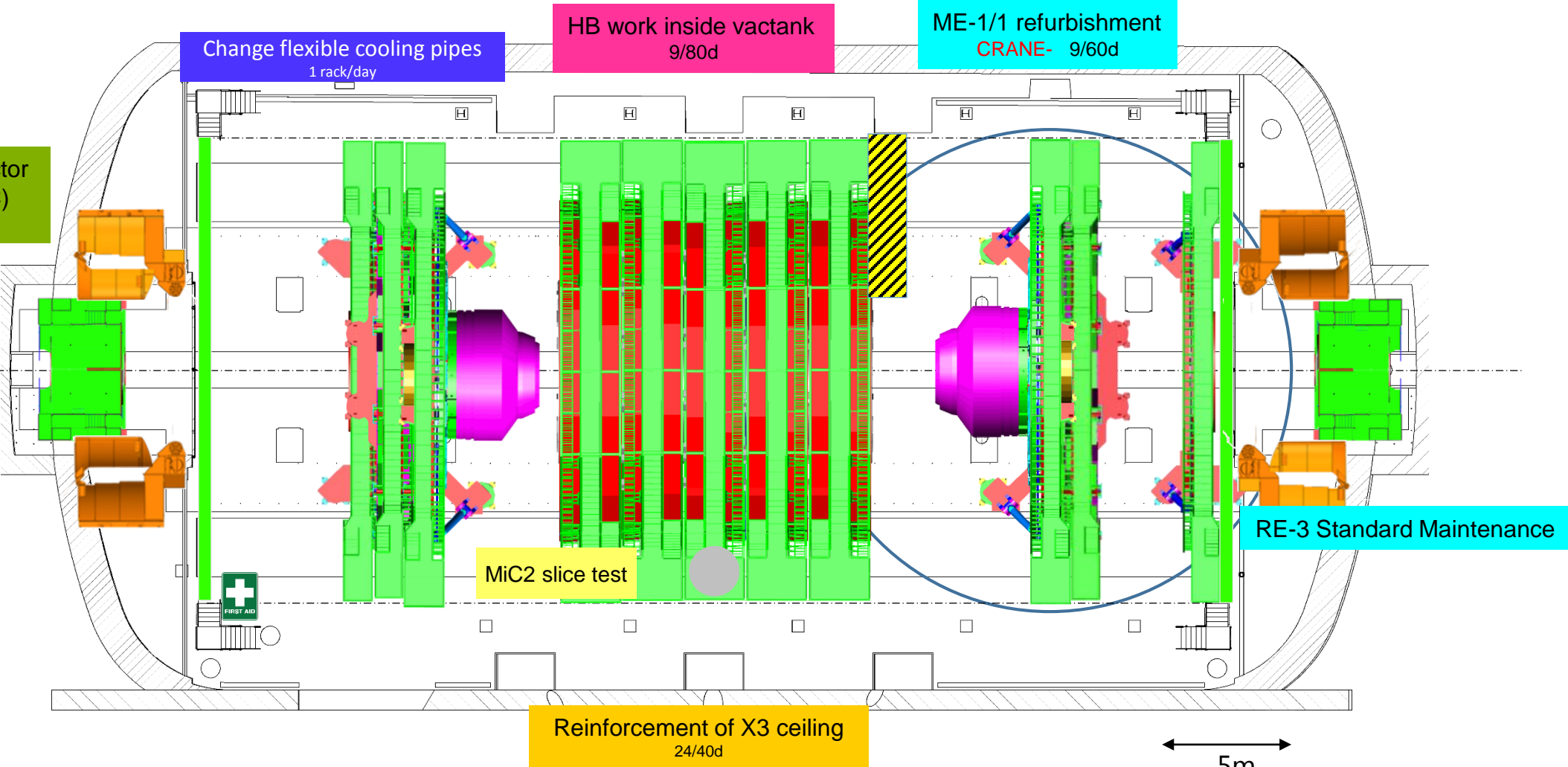

RE-3 Standard Maintenance

MiC2 slice test

Reinforcement of X3 ceiling 24/40d

5m



Crane

Cryo.	EL power	Water cool.	Database				
IT	Magnet	C6F14	Gas				
SL. 0	GEM	ECAL	ZEC	DT+ RB	Survey	TE-VSC	SMB
CP. 0	TOTEM	CMX	CSC RE	TK PIX	HCAL	EN Dept	RP

PX56 Plug OPEN

TX54 Plug OPEN

Friday

08. March 2019

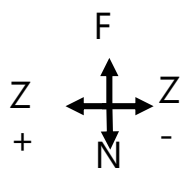

ME+4/1 Flow restrictor replacement (ZEC) 2/2d

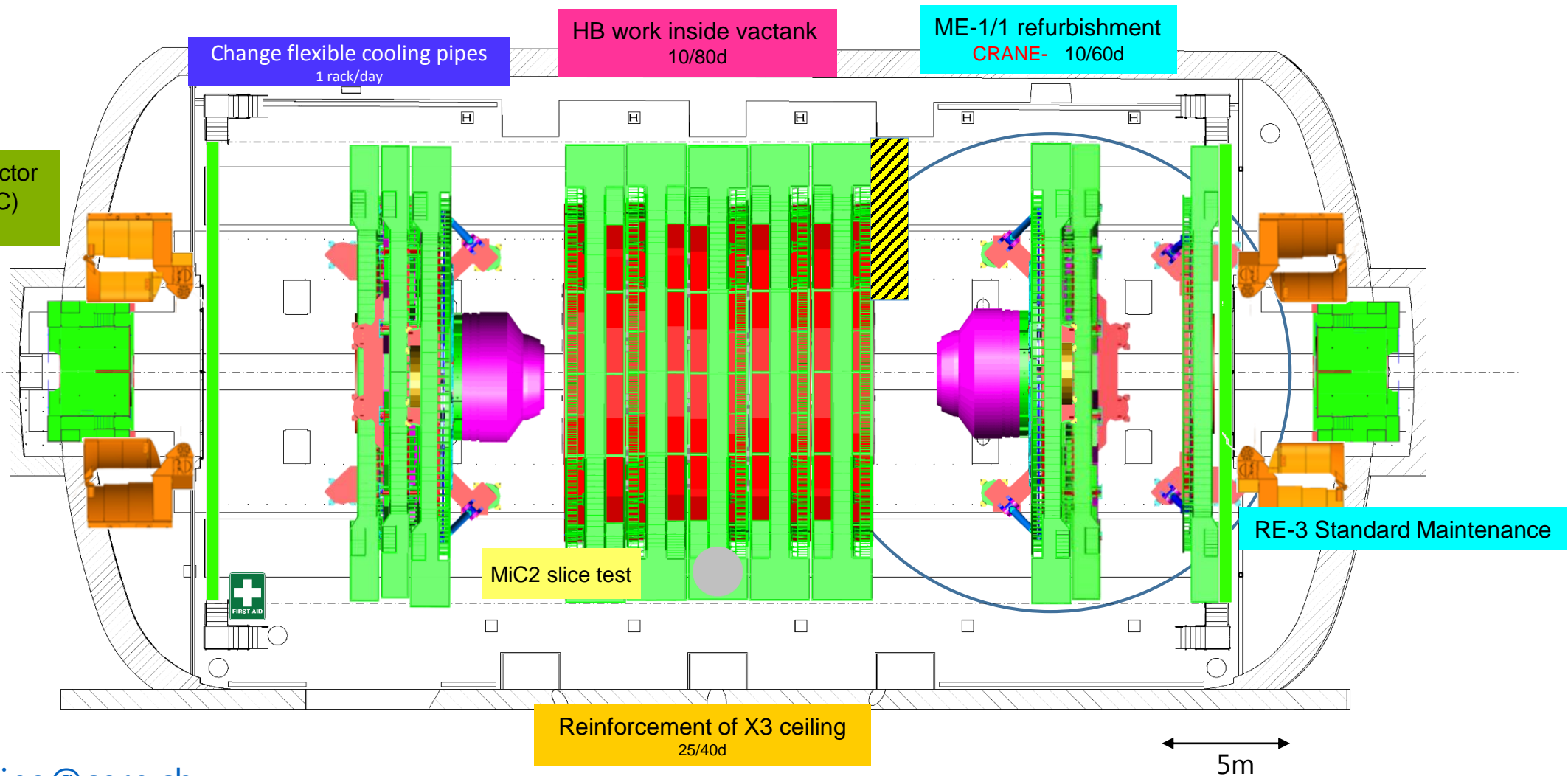



Crane

Cryo.	EL power	Water cool.	Database				
IT	Magnet	C6F14	Gas				
SL. 0	GEM	ECAL	ZEC	DT+ RB	Survey	TE-VSC	SMB
CP. 0	TOTEM	CMX	CSC RE	TK PIX	HCAL	EN Dept	RP

PX56 Plug OPEN

Saturday

TX54 Plug OPEN

09. March 2019

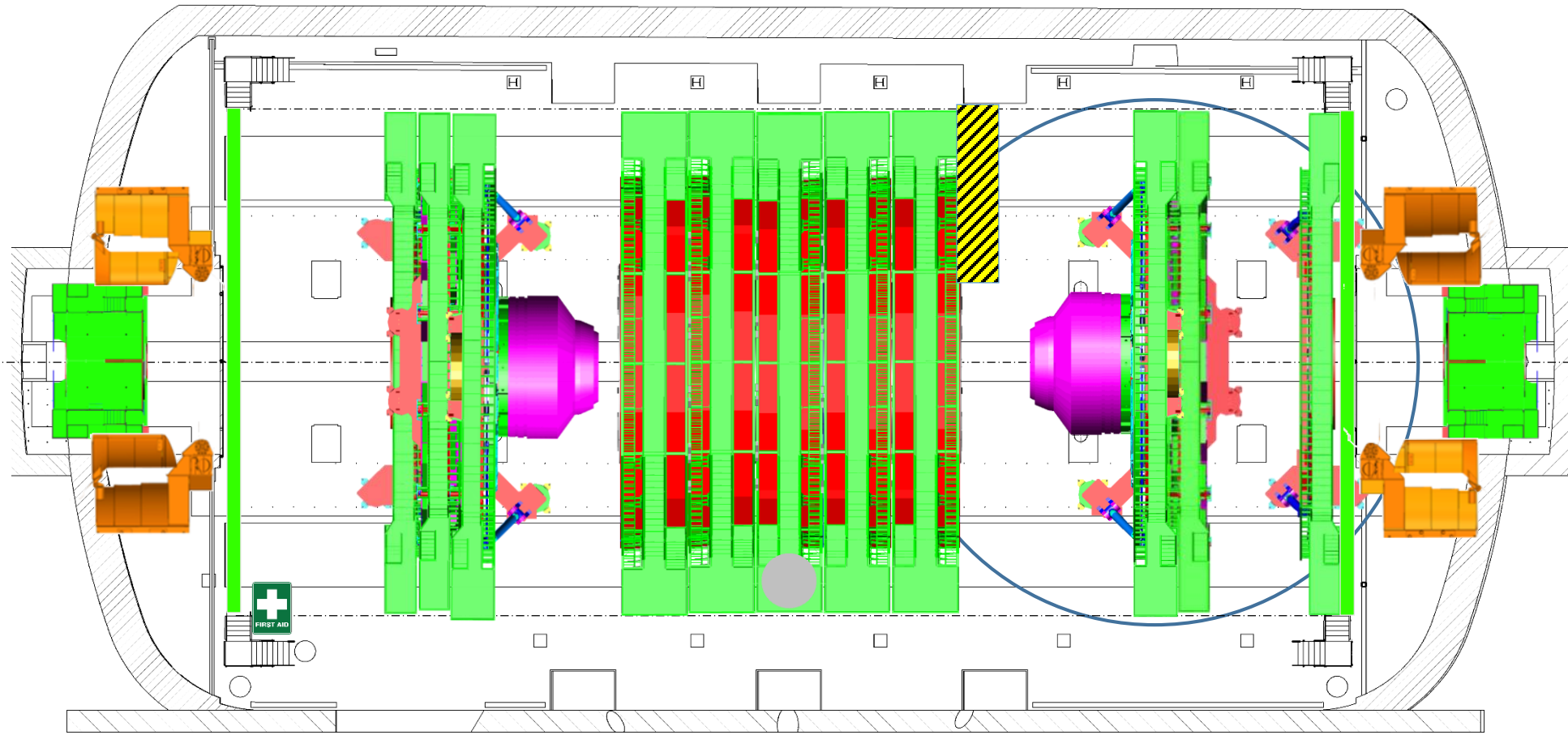
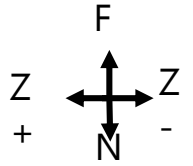

5m



Crane

Cryo.	EL power	Water cool.	Database				
IT	Magnet	C6F14	Gas				
SL. 0	GEM	ECAL	ZEC	DT+ RB	Survey	TE-VSC	SMB
CP. 0	TOTEM	CMX	CSC RE	TK PIX	HCAL	EN Dept	RP

PX56 Plug
OPEN

TX54 Plug
OPEN

Sunday

10. March 2019

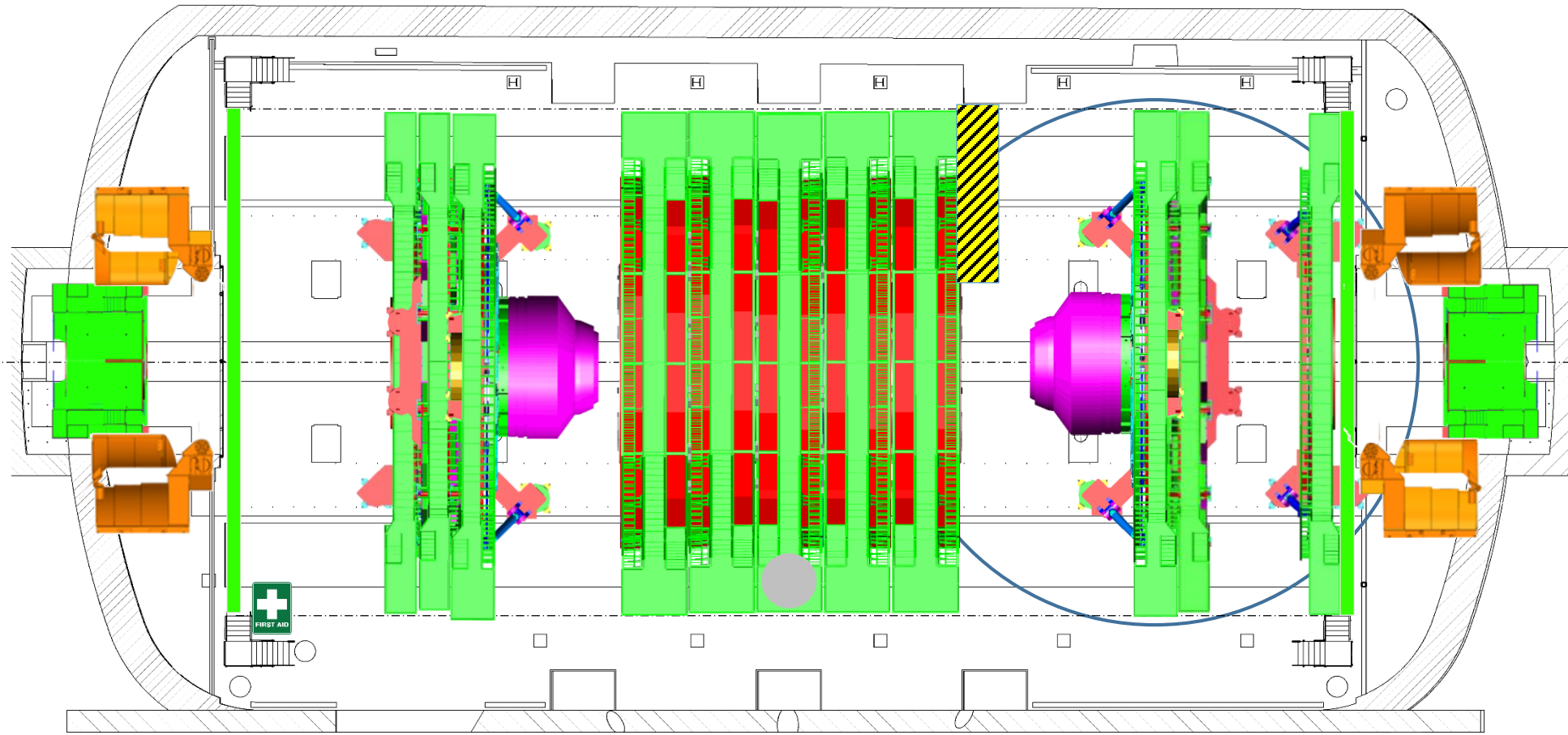

5m



Crane

Cryo.	EL power	Water cool.	Database				
IT	Magnet	C6F14	Gas				
SL. 0	GEM	ECAL	ZEC	DT+ RB	Survey	TE-VSC	SMB
CP. 0	TOTEM	CMX	CSC RE	TK PIX	HCAL	EN Dept	RP

PX56 Plug
OPEN

TX54 Plug
OPEN

Monday

11. March 2019

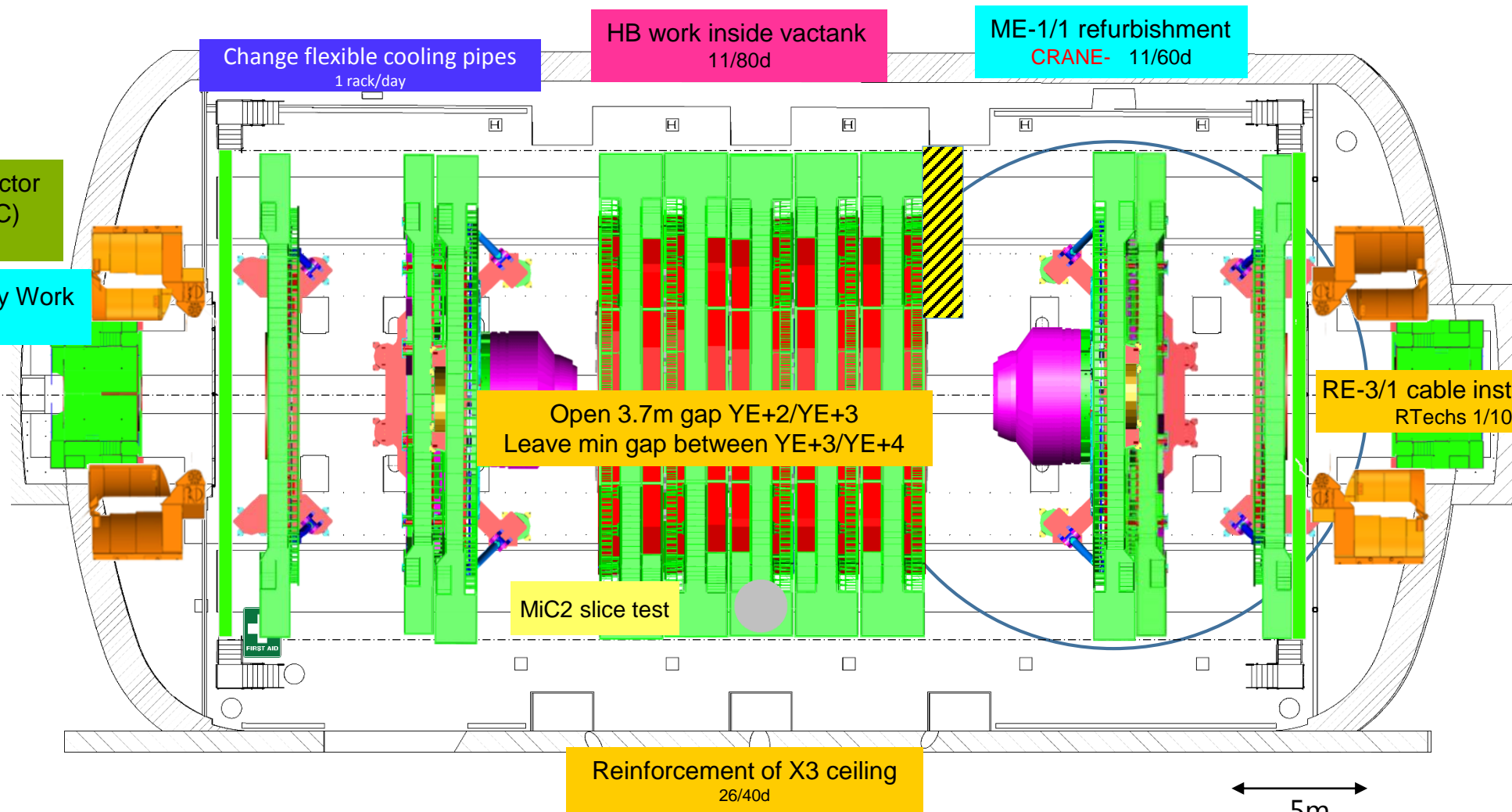
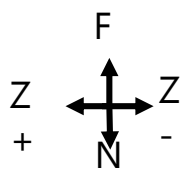



Crane

Cryo.	EL power	Water cool.	Database				
IT	Magnet	C6F14	Gas				
SL. 0	GEM	ECAL	ZEC	DT+ RB	Survey	TE-VSC	SMB
CP. 0	TOTEM	CMX	CSC RE	TK PIX	HCAL	EN Dept	RP

PX56 Plug
OPEN

TX54 Plug
OPEN

Tuesday

12. March 2019

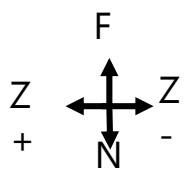

ME+3/1 Flow restrictor replacement (ZEC) 2/2d

ME+3/1 Preparatory Work 2/3d

ME+3 Standard Maintenance

Change flexible cooling pipes 1 rack/day

HB work inside vactank 12/80d

ME-1/1 refurbishment CRANE- 12/60d

RE-3/1 cable installation RTechs 2/10d

Phase 2 opening system installation Z- NEAR 1/5d

MiC2 slice test

Reinforcement of X3 ceiling 27/40d

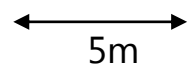



Crane

Cryo.	EL power	Water cool.	Database				
IT	Magnet	C6F14	Gas				
SL. 0	GEM	ECAL	ZEC	DT+ RB	Survey	TE-VSC	SMB
CP. 0	TOTEM	CMX	CSC RE	TK PIX	HCAL	EN Dept	RP

PX56 Plug OPEN

Wednesday

TX54 Plug OPEN

13. March 2019

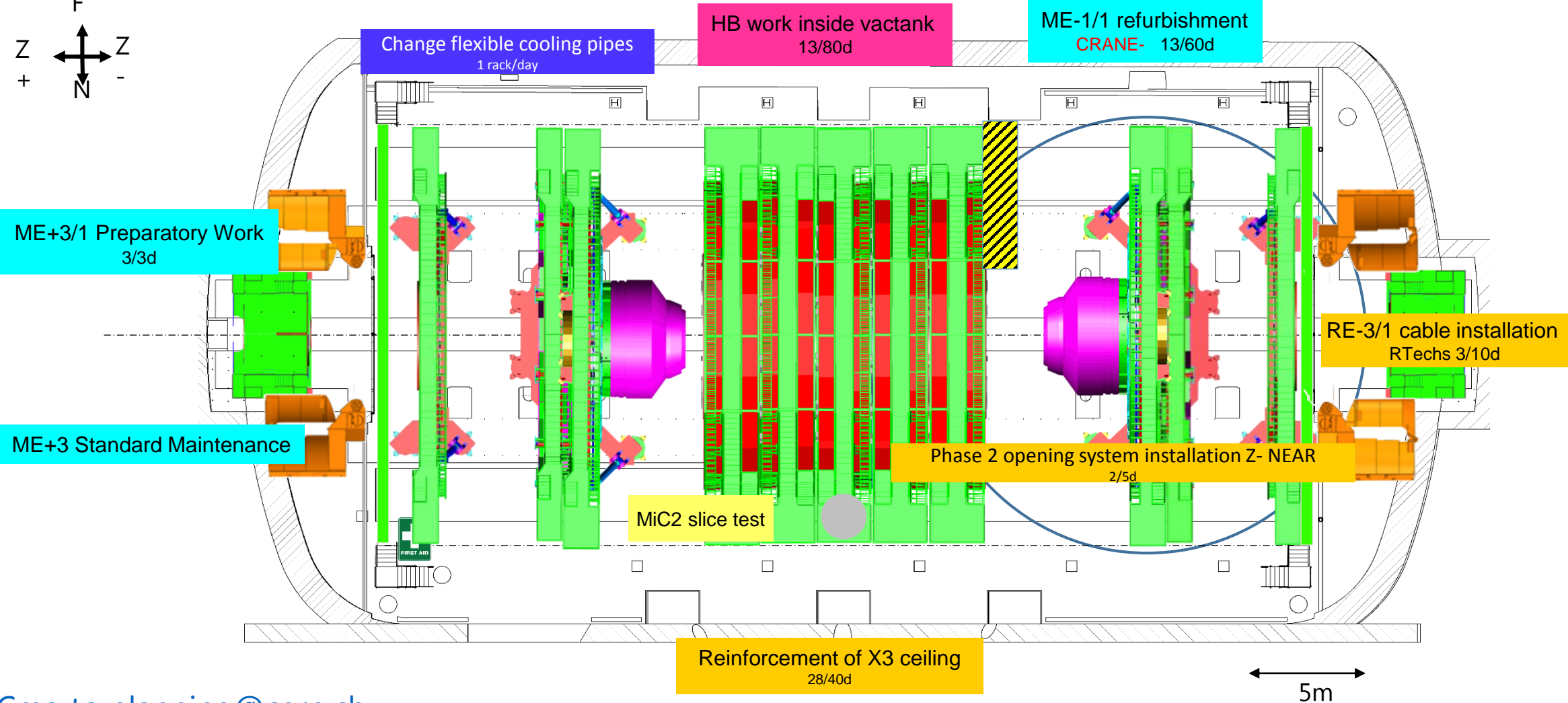
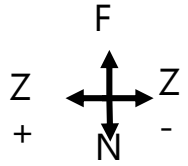



Crane

Cryo.	EL power	Water cool.	Database				
IT	Magnet	C6F14	Gas				
SL. 0	GEM	ECAL	ZEC	DT+ RB	Survey	TE-VSC	SMB
CP. 0	TOTEM	CMX	CSC RE	TK PIX	HCAL	EN Dept	RP

PX56 Plug OPEN
TX54 Plug OPEN

Thursday
14. March 2019

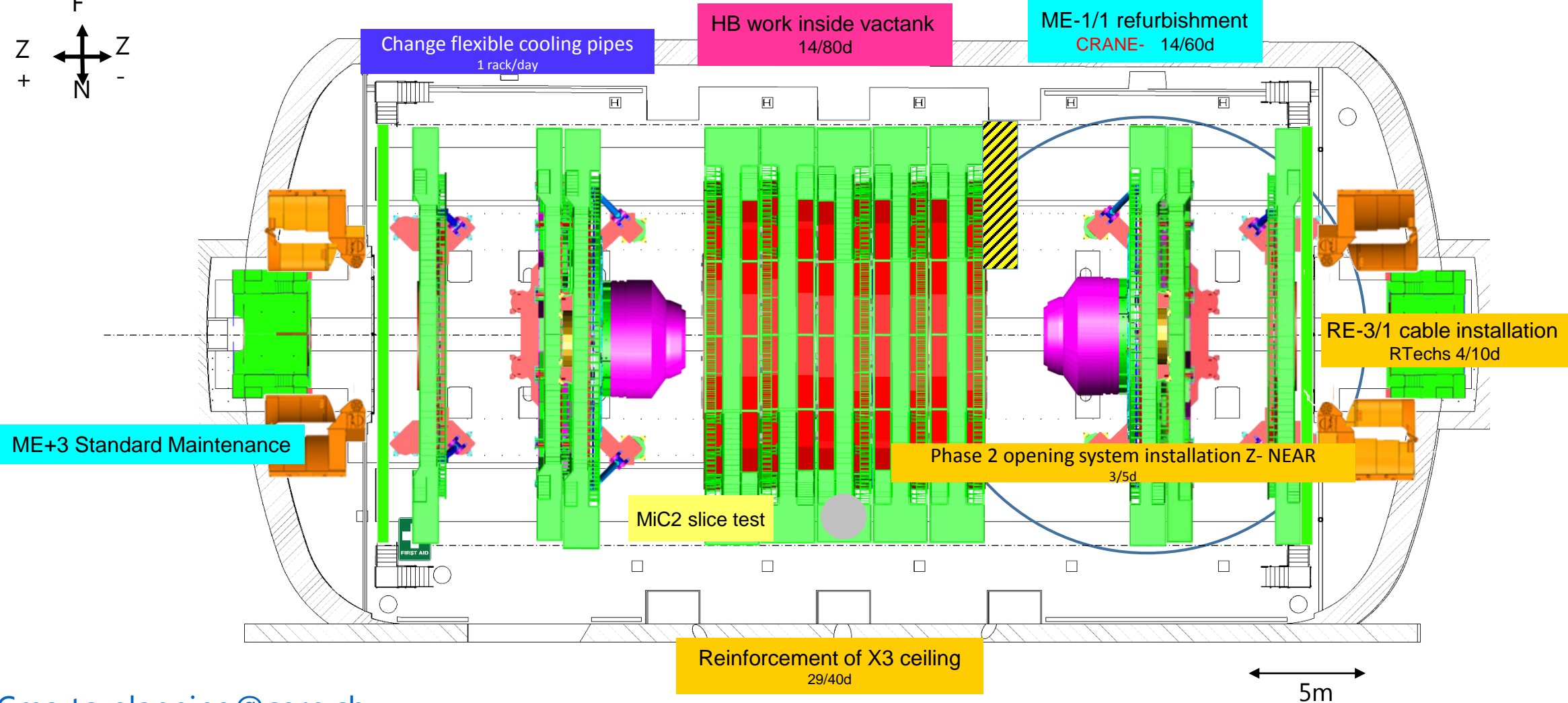
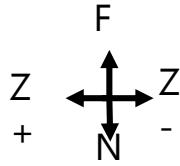



Crane

Cryo.	EL power	Water cool.	Database				
IT	Magnet	C6F14	Gas				
SL. 0	GEM	ECAL	ZEC	DT+ RB	Survey	TE-VSC	SMB
CP. 0	TOTEM	CMX	CSC RE	TK PIX	HCAL	EN Dept	RP

PX56 Plug OPEN

Friday

TX54 Plug OPEN

15. March 2019

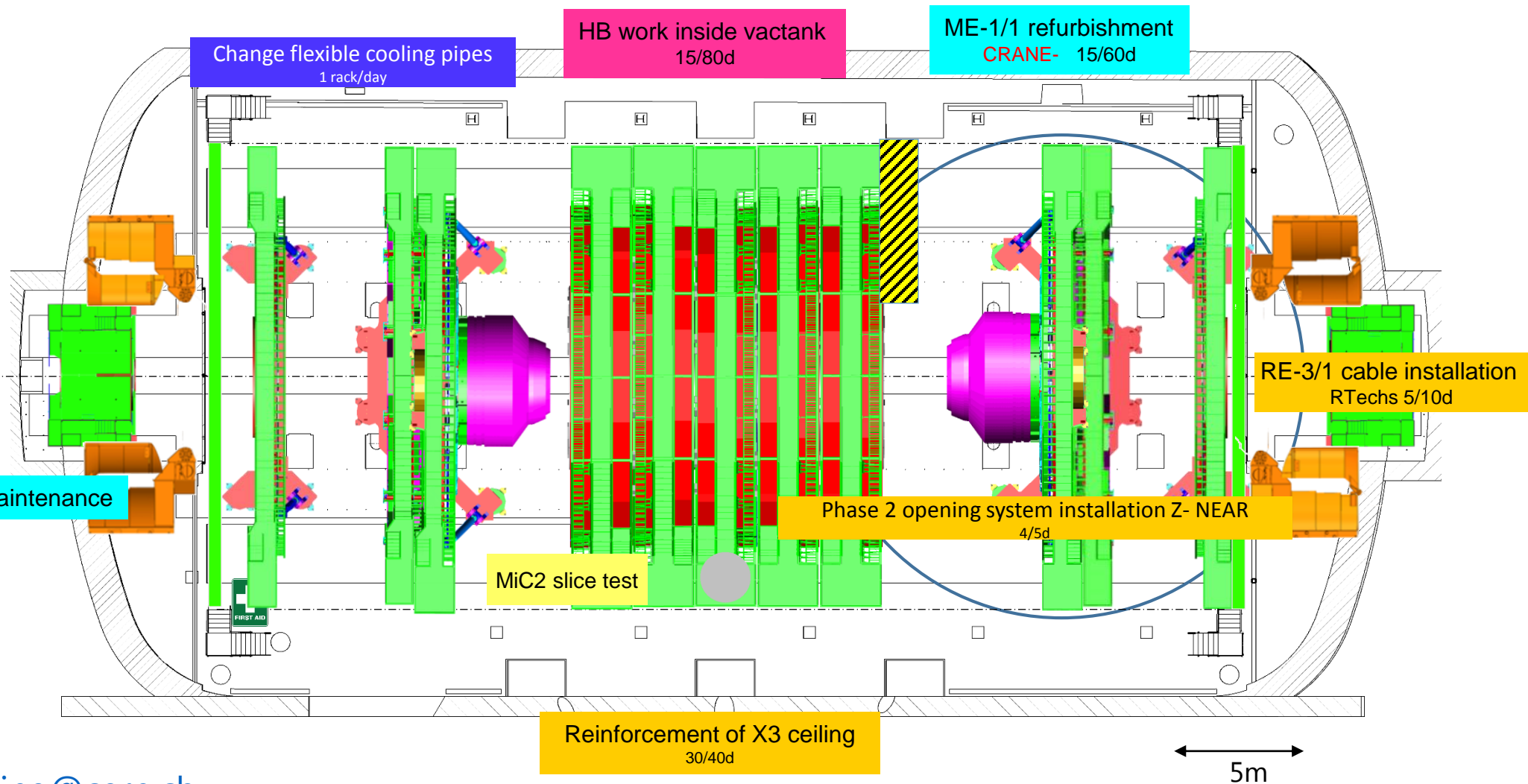
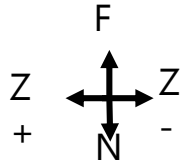



Crane

Cryo.	EL power	Water cool.	Database				
IT	Magnet	C6F14	Gas				
SL. 0	GEM	ECAL	ZEC	DT+ RB	Survey	TE-VSC	SMB
CP. 0	TOTEM	CMX	CSC RE	TK PIX	HCAL	EN Dept	RP

PX56 Plug OPEN

Saturday

TX54 Plug OPEN

16. March 2019

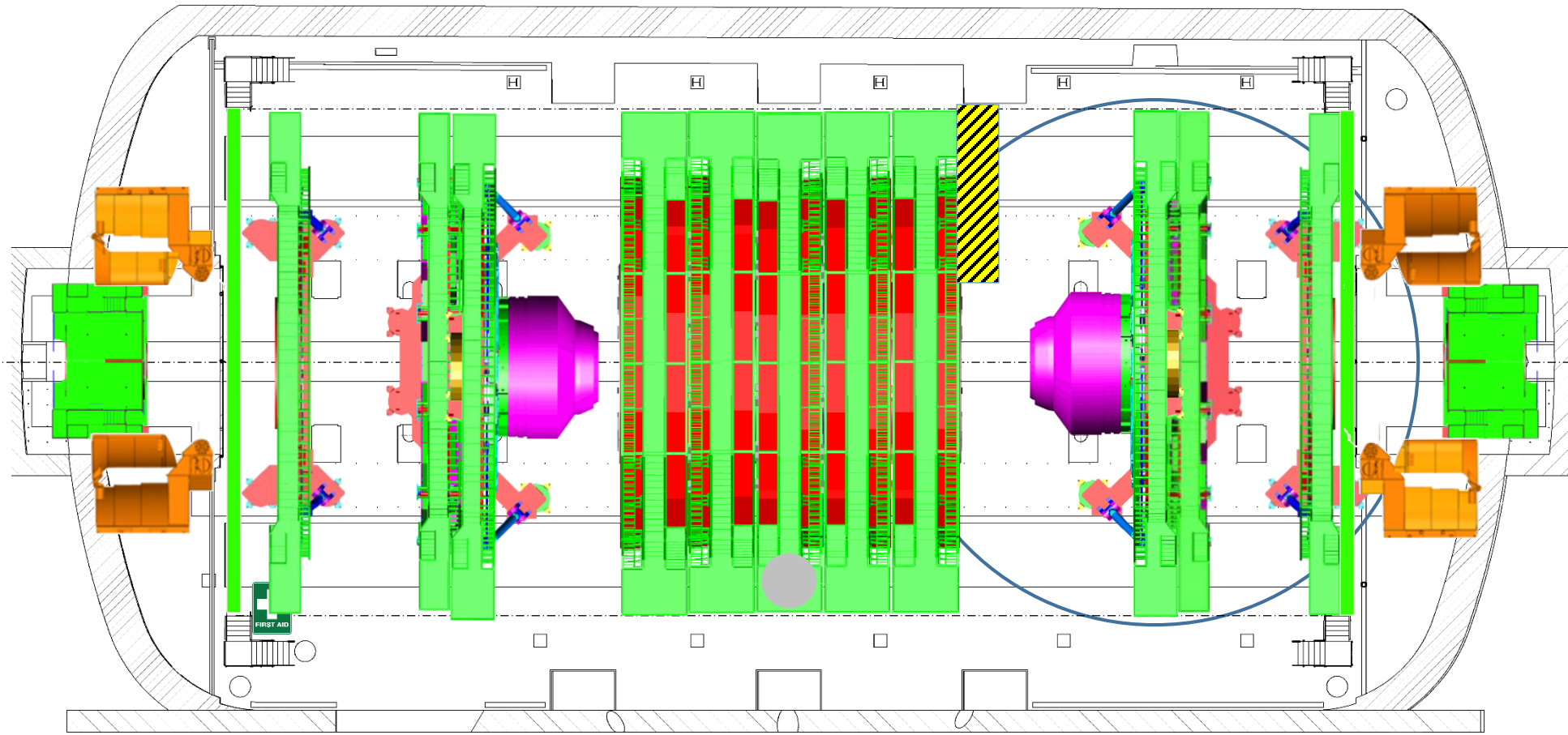
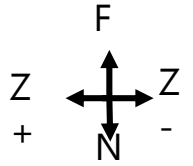

5m



Crane

Cryo.	EL power	Water cool.	Database				
IT	Magnet	C6F14	Gas				
SL. 0	GEM	ECAL	ZEC	DT+ RB	Survey	TE-VSC	SMB
CP. 0	TOTEM	CMX	CSC RE	TK PIX	HCAL	EN Dept	RP

PX56 Plug OPEN

Sunday

TX54 Plug OPEN

17. March 2019

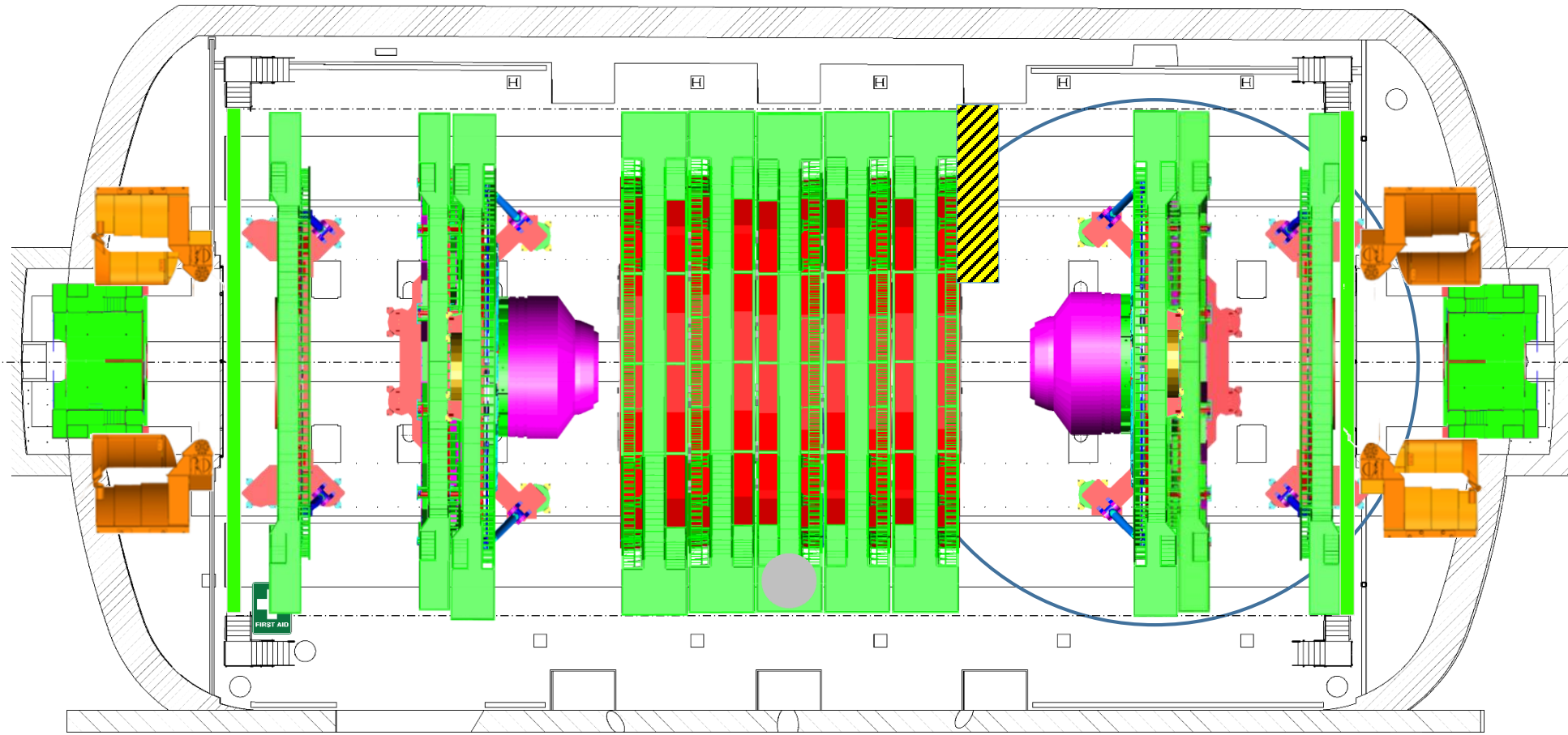
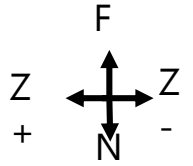

5m



Crane

Cryo.	EL power	Water cool.	Database				
IT	Magnet	C6F14	Gas				
SL. 0	GEM	ECAL	ZEC	DT+ RB	Survey	TE-VSC	SMB
CP. 0	TOTEM	CMX	CSC RE	TK PIX	HCAL	EN Dept	RP

PX56 Plug OPEN
TX54 Plug OPEN

Monday
18. March 2019

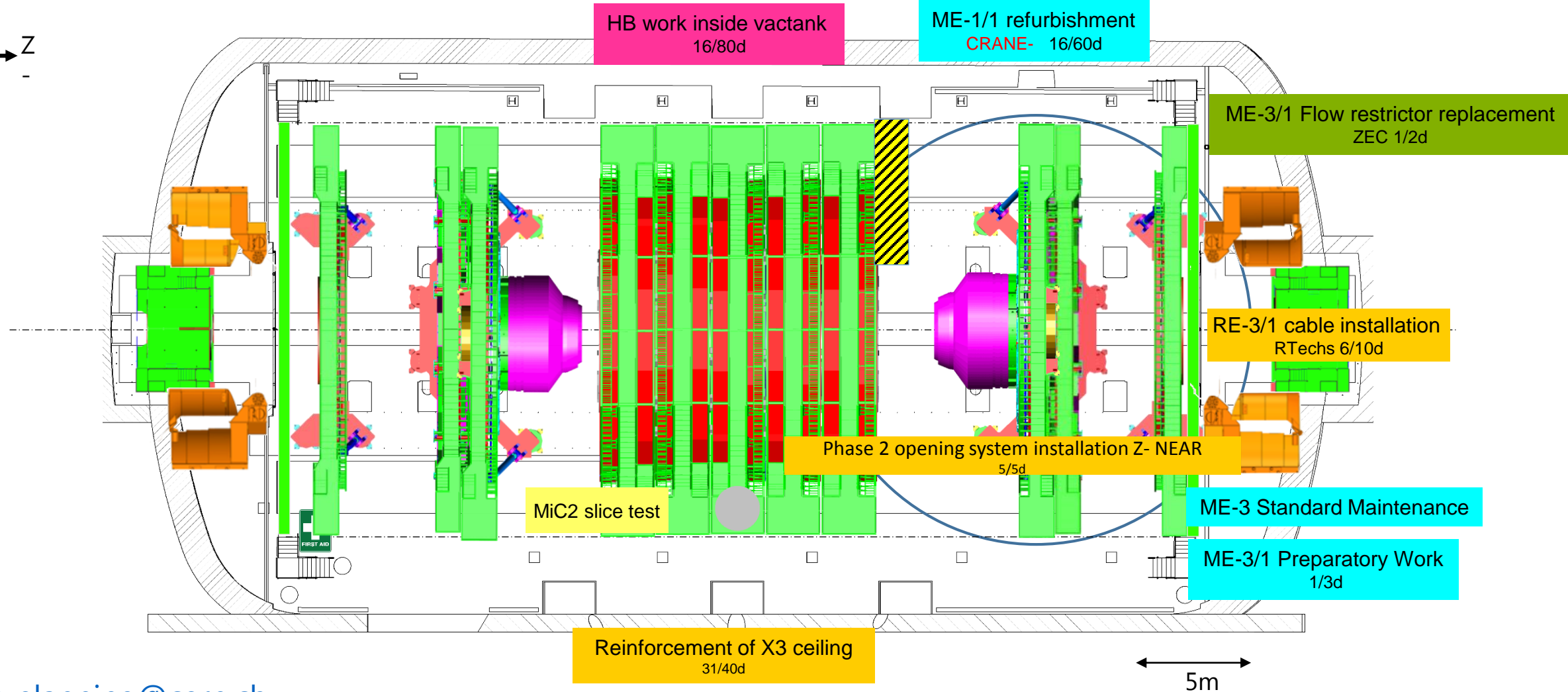
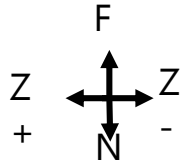



Crane

Cryo.	EL power	Water cool.	Database				
IT	Magnet	C6F14	Gas				
SL. 0	GEM	ECAL	ZEC	DT+ RB	Survey	TE-VSC	SMB
CP. 0	TOTEM	CMX	CSC RE	TK PIX	HCAL	EN Dept	RP

PX56 Plug OPEN

Tuesday

TX54 Plug OPEN

19. March 2019

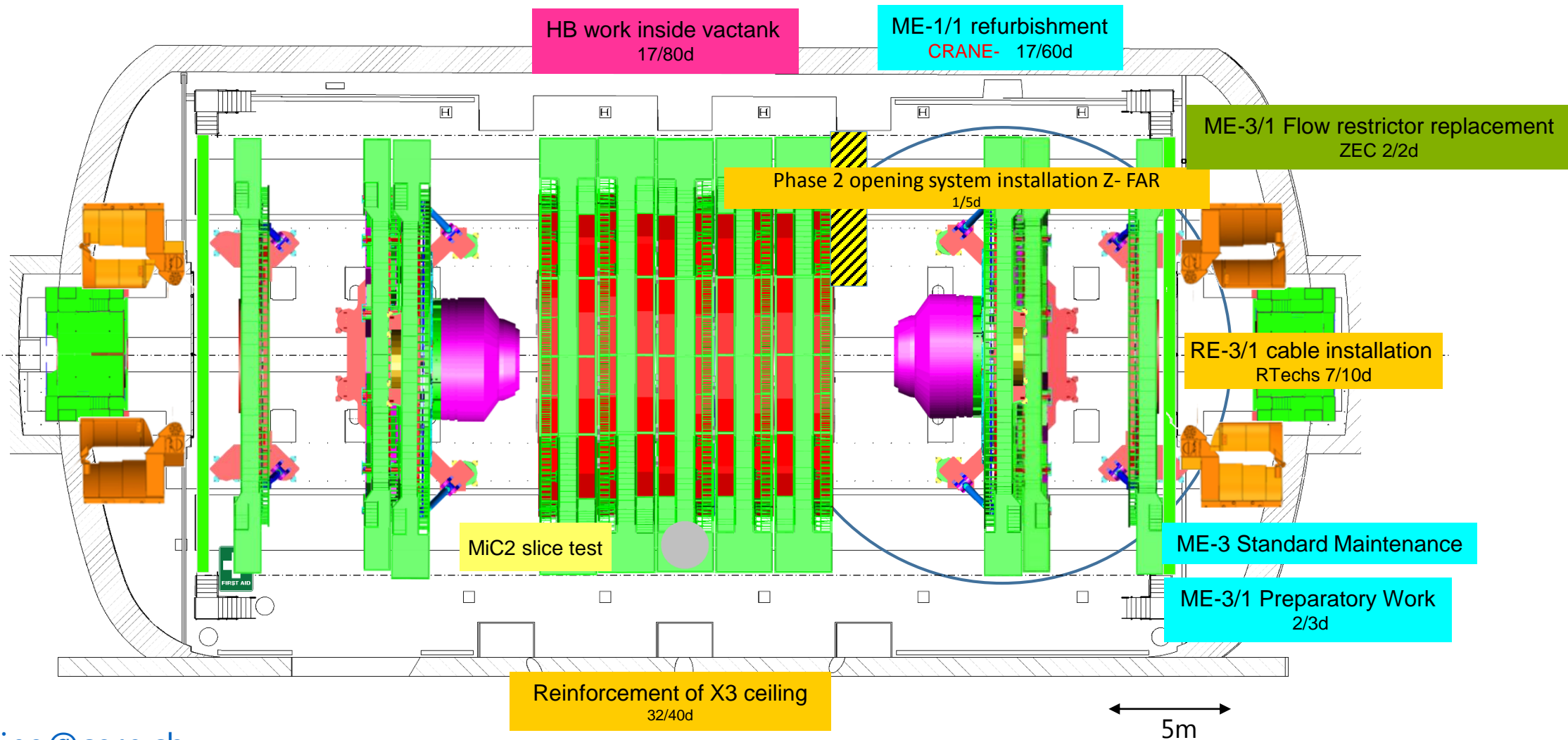
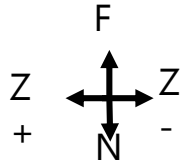

5m



Crane

Cryo.	EL power	Water cool.	Database				
IT	Magnet	C6F14	Gas				
SL. 0	GEM	ECAL	ZEC	DT+ RB	Survey	TE-VSC	SMB
CP. 0	TOTEM	CMX	CSC RE	TK PIX	HCAL	EN Dept	RP

PX56 Plug
OPEN

TX54 Plug
OPEN

Wednesday

20. March 2019

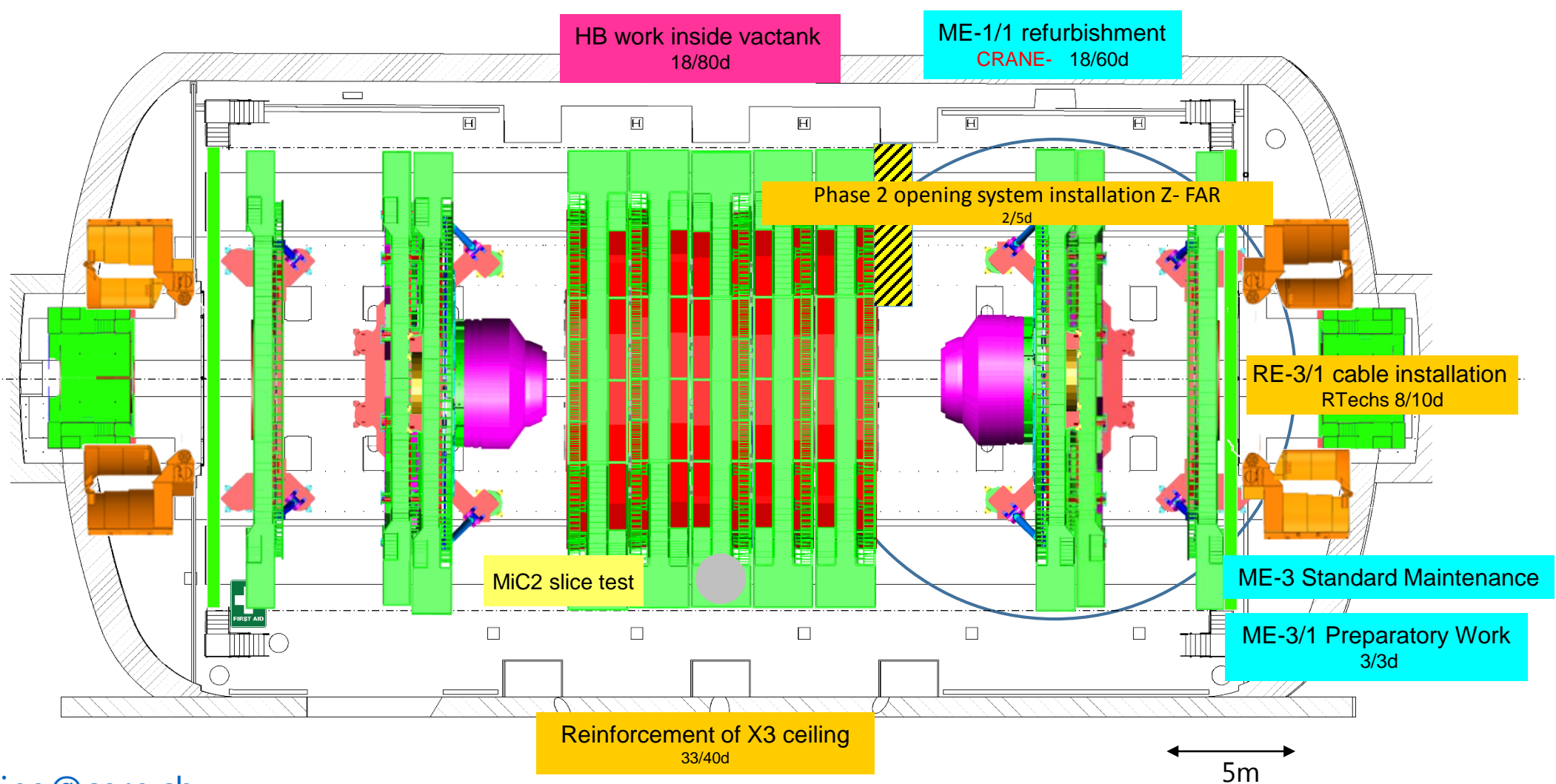



Crane

Cryo.	EL power	Water cool.	Database				
IT	Magnet	C6F14	Gas				
SL. 0	GEM	ECAL	ZEC	DT+ RB	Survey	TE-VSC	SMB
CP. 0	TOTEM	CMX	CSC RE	TK PIX	HCAL	EN Dept	RP

PX56 Plug OPEN
TX54 Plug OPEN

Thursday
21. March 2019

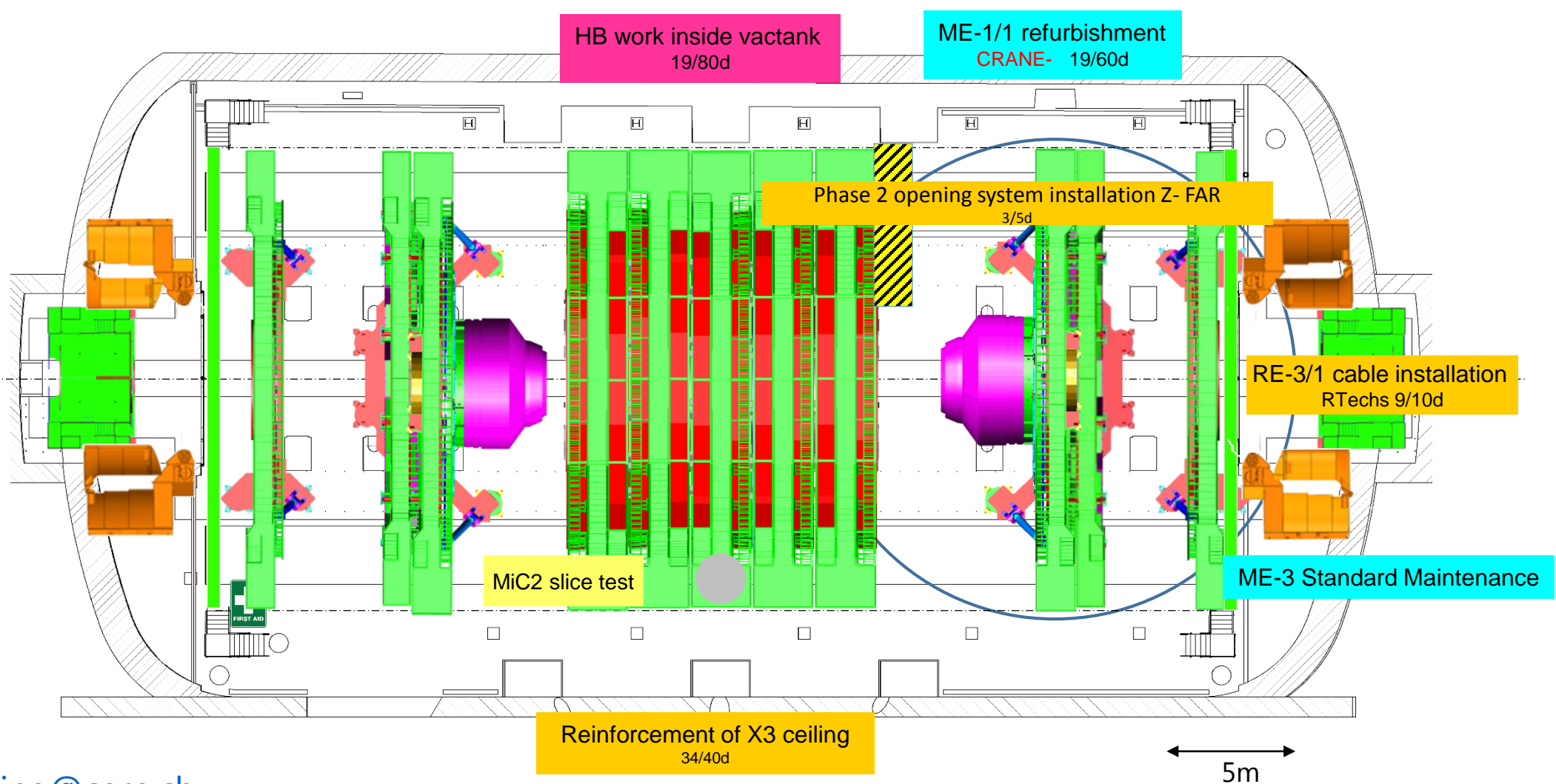



Crane

Cryo.	EL power	Water cool.	Database				
IT	Magnet	C6F14	Gas				
SL. 0	GEM	ECAL	ZEC	DT+ RB	Survey	TE-VSC	SMB
CP. 0	TOTEM	CMX	CSC RE	TK PIX	HCAL	EN Dept	RP

PX56 Plug OPEN
TX54 Plug OPEN

Friday
22. March 2019

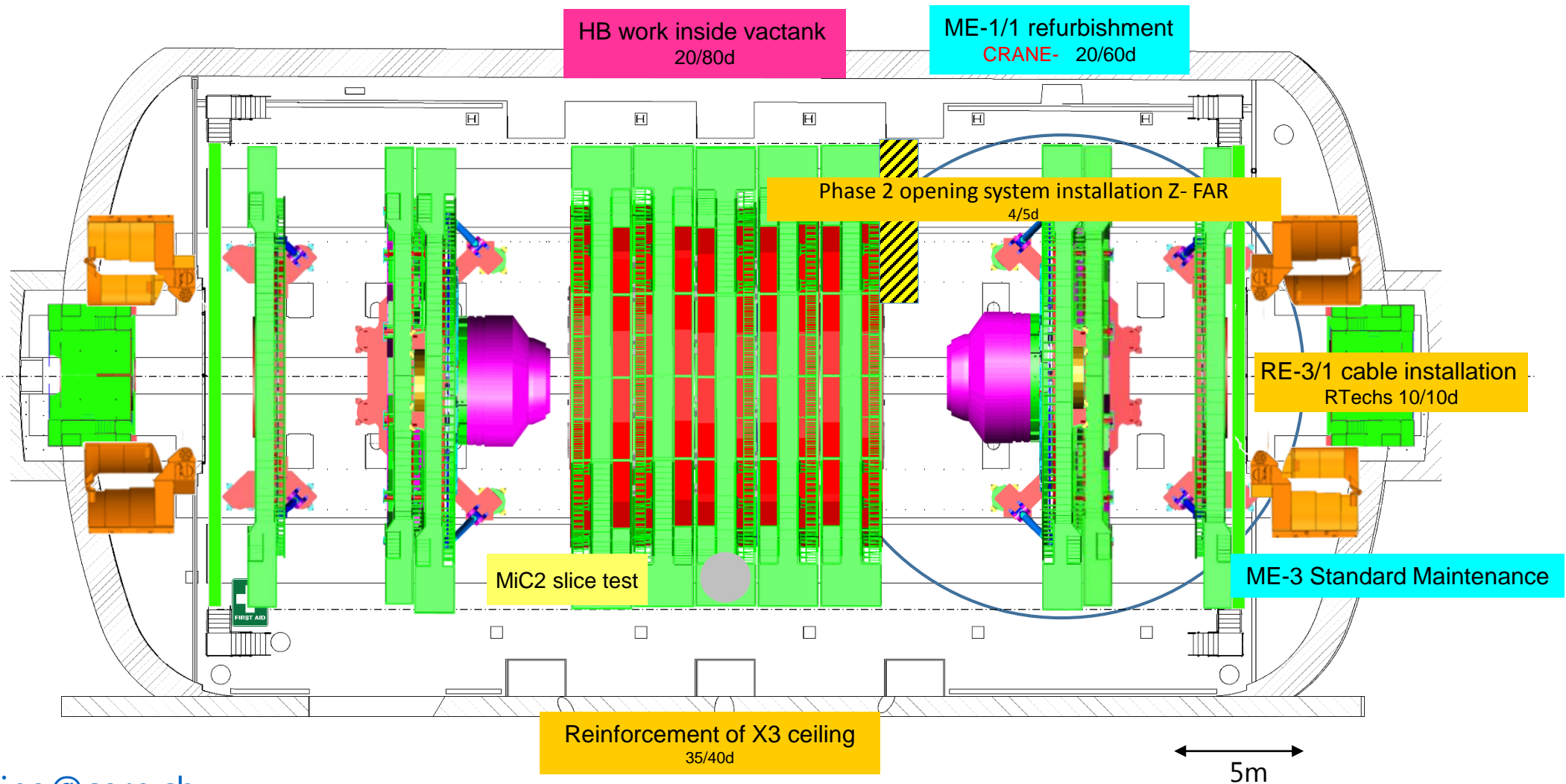
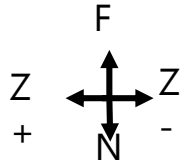



Crane

Cryo.	EL power	Water cool.	Database				
IT	Magnet	C6F14	Gas				
SL. 0	GEM	ECAL	ZEC	DT+ RB	Survey	TE-VSC	SMB
CP. 0	TOTEM	CMX	CSC RE	TK PIX	HCAL	EN Dept	RP

PX56 Plug OPEN
TX54 Plug OPEN

Saturday
23. March 2019

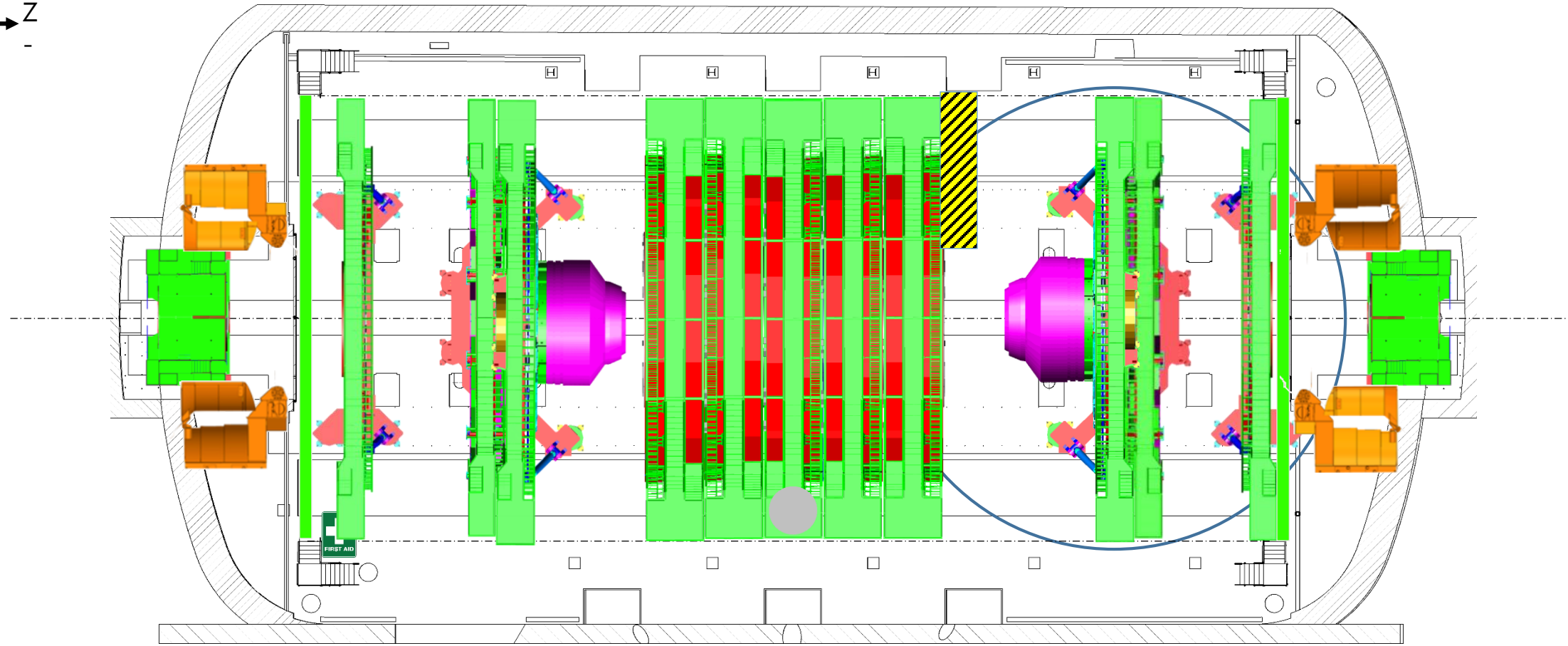
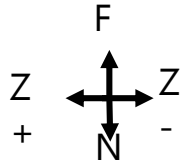

5m



Crane

Cryo.	EL power	Water cool.	Database				
IT	Magnet	C6F14	Gas				
SL. 0	GEM	ECAL	ZEC	DT+ RB	Survey	TE-VSC	SMB
CP. 0	TOTEM	CMX	CSC RE	TK PIX	HCAL	EN Dept	RP

PX56 Plug
OPEN

TX54 Plug
OPEN

Sunday

24. March 2019

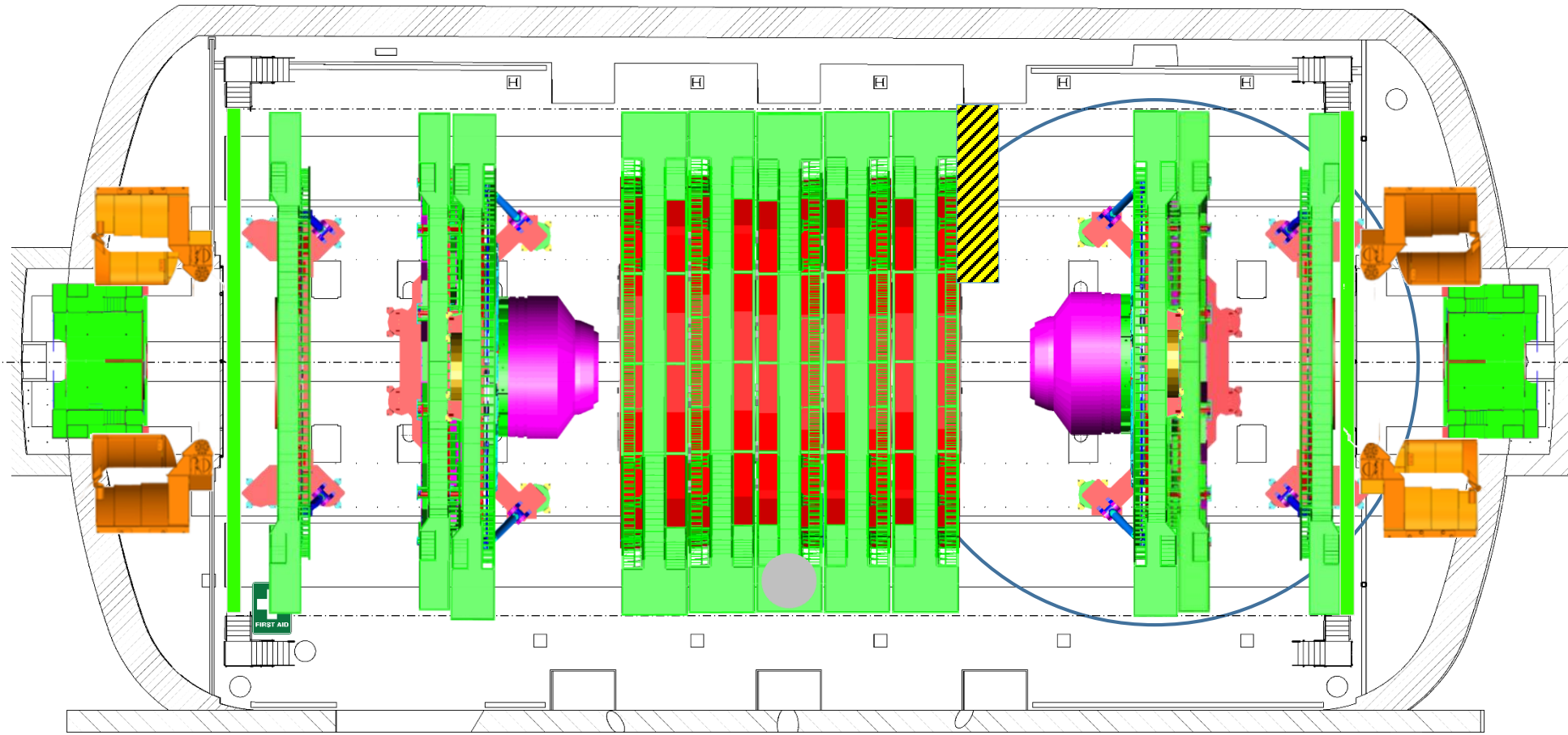
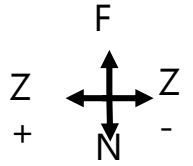

5m



Crane

Cryo.	EL power	Water cool.	Database				
IT	Magnet	C6F14	Gas				
SL. 0	GEM	ECAL	ZEC	DT+ RB	Survey	TE-VSC	SMB
CP. 0	TOTEM	CMX	CSC RE	TK PIX	HCAL	EN Dept	RP

PX56 Plug OPEN
TX54 Plug OPEN

Monday
25. March 2019

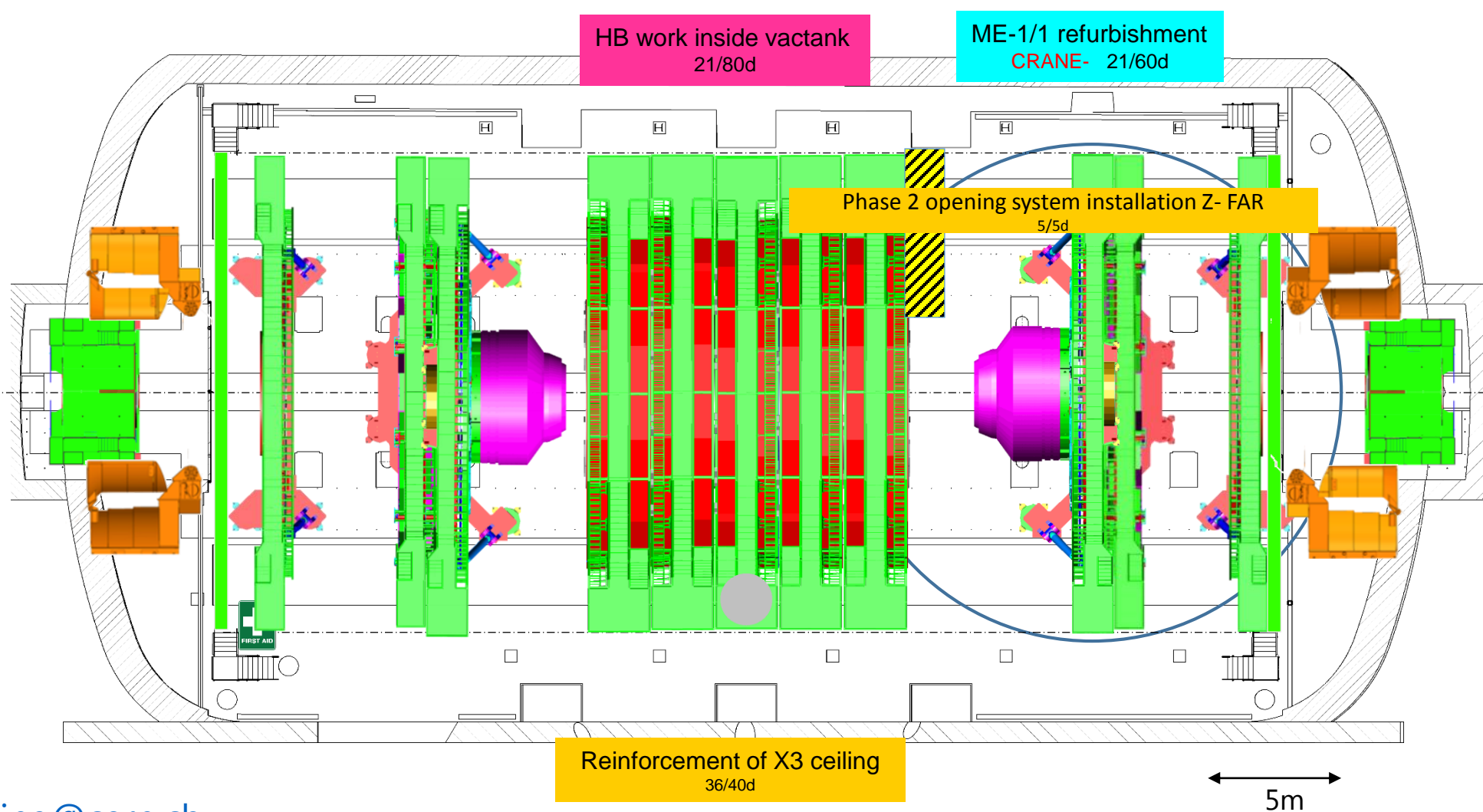



Crane

Cryo.	EL power	Water cool.	Database				
IT	Magnet	C6F14	Gas				
SL. 0	GEM	ECAL	ZEC	DT+ RB	Survey	TE-VSC	SMB
CP. 0	TOTEM	CMX	CSC RE	TK PIX	HCAL	EN Dept	RP

PX56 Plug OPEN
TX54 Plug OPEN

Tuesday
26. March 2019

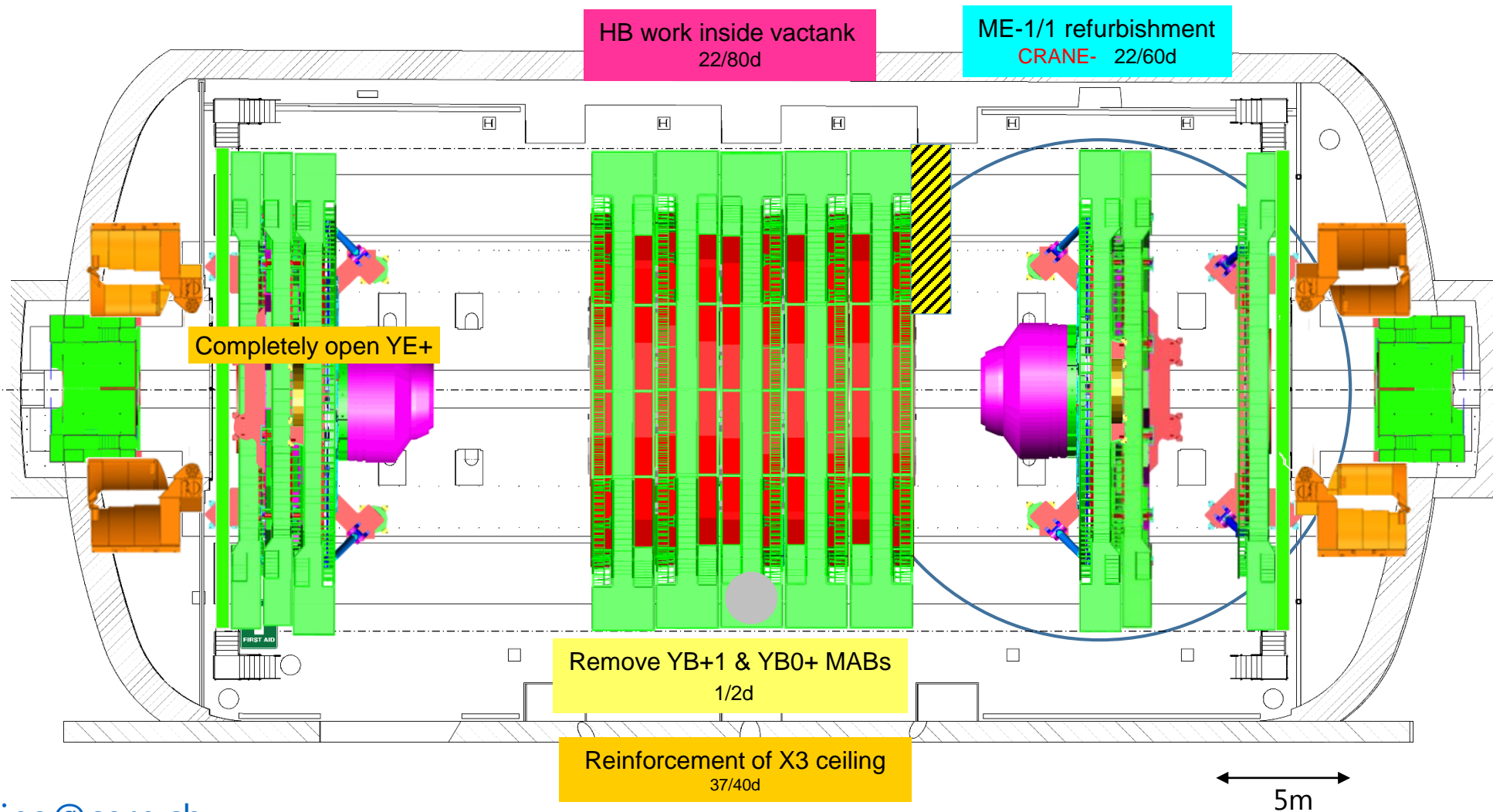



Crane

Cryo.	EL power	Water cool.	Database				
IT	Magnet	C6F14	Gas				
SL. 0	GEM	ECAL	ZEC	DT+ RB	Survey	TE-VSC	SMB
CP. 0	TOTEM	CMX	CSC RE	TK PIX	HCAL	EN Dept	RP

PX56 Plug OPEN
TX54 Plug OPEN

Wednesday
27. March 2019

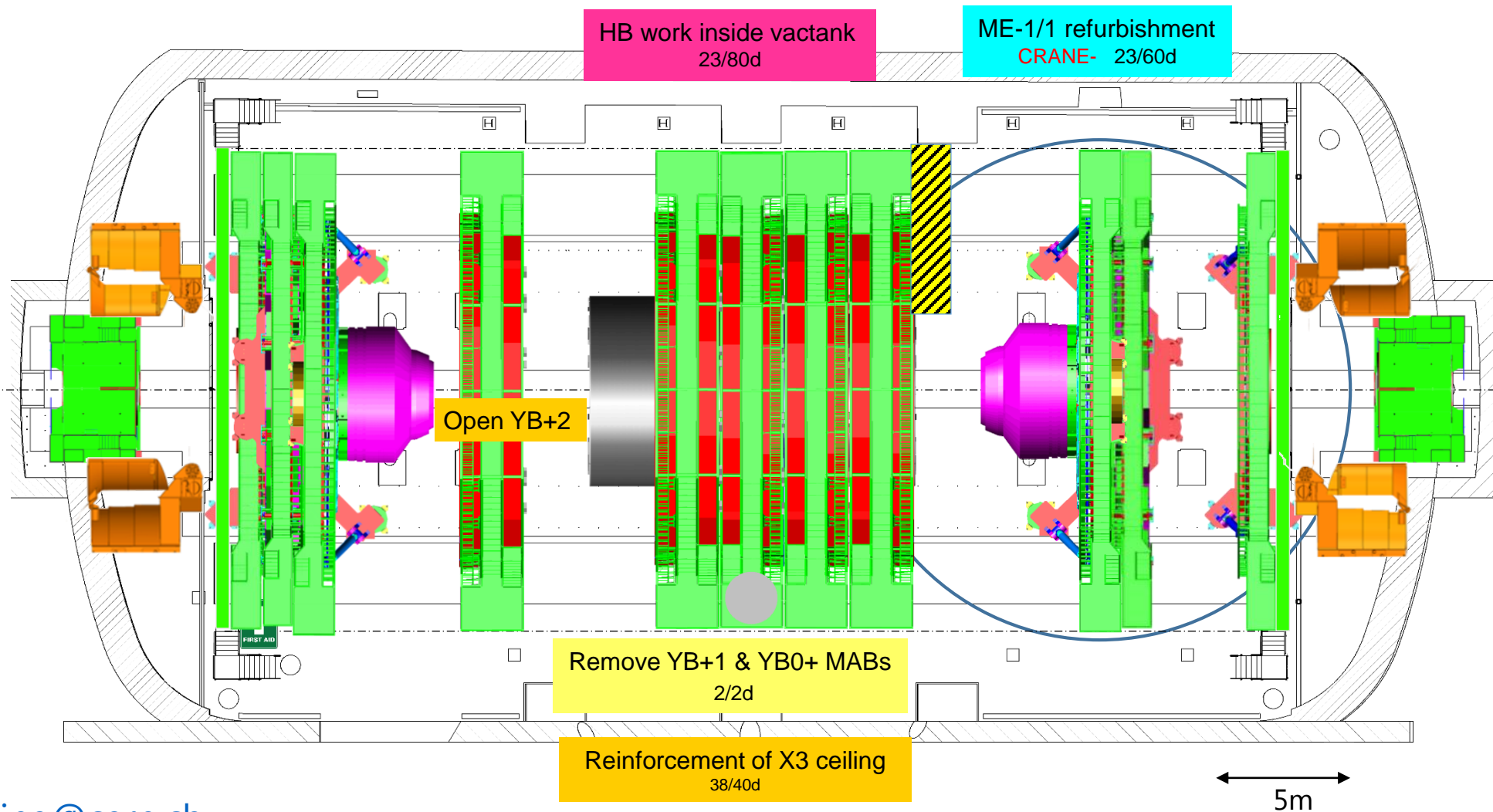
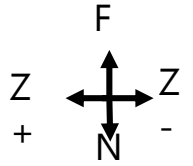



Crane

Cryo.	EL power	Water cool.	Database				
IT	Magnet	C6F14	Gas				
SL. 0	GEM	ECAL	ZEC	DT+ RB	Survey	TE-VSC	SMB
CP. 0	TOTEM	CMX	CSC RE	TK PIX	HCAL	EN Dept	RP

PX56 Plug OPEN
TX54 Plug OPEN

Thursday
28. March 2019

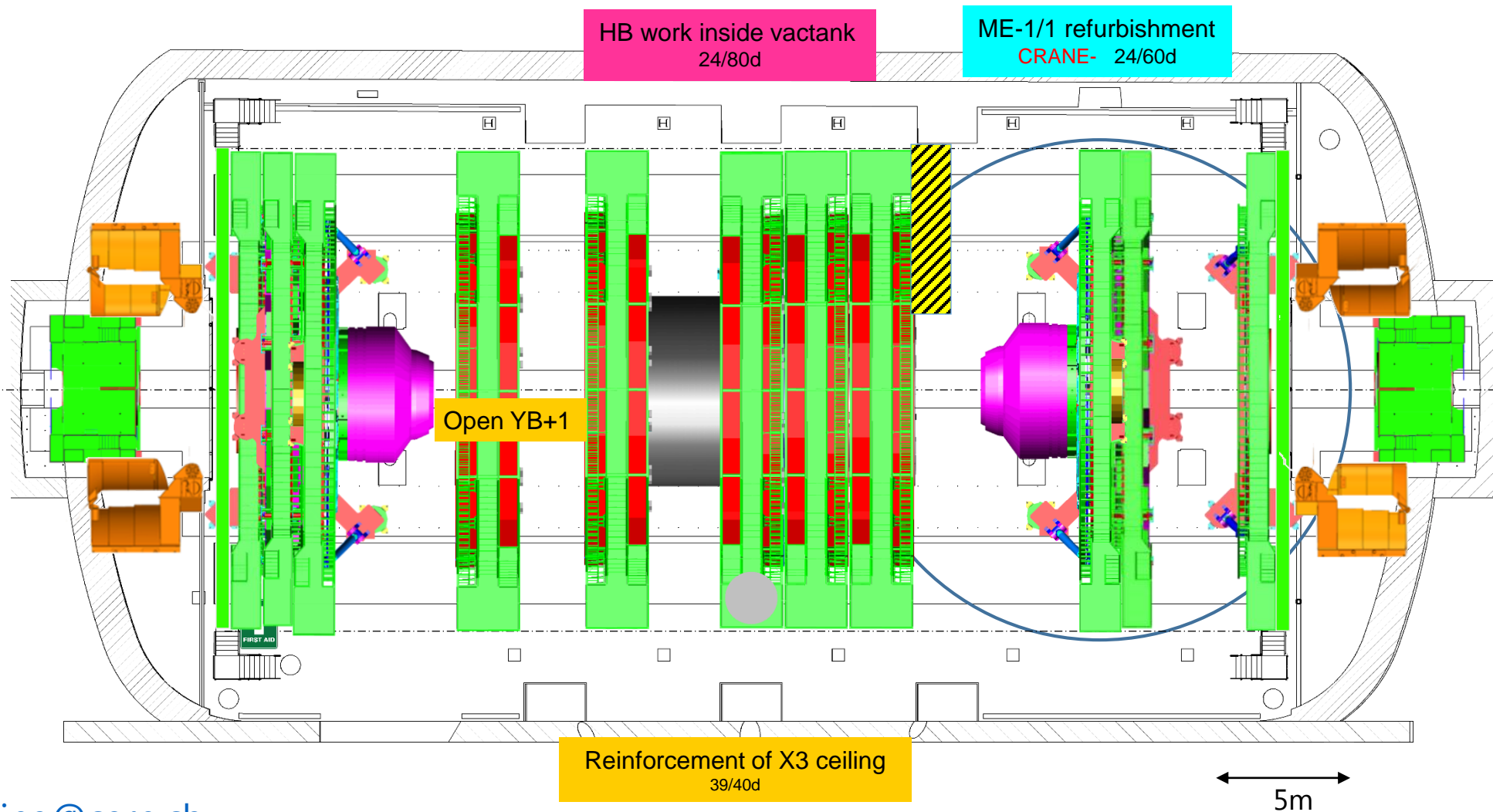
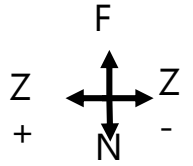



Crane

Cryo.	EL power	Water cool.	Database				
IT	Magnet	C6F14	Gas				
SL. 0	GEM	ECAL	ZEC	DT+ RB	Survey	TE-VSC	SMB
CP. 0	TOTEM	CMX	CSC RE	TK PIX	HCAL	EN Dept	RP

PX56 Plug OPEN
TX54 Plug OPEN

Friday
29. March 2019

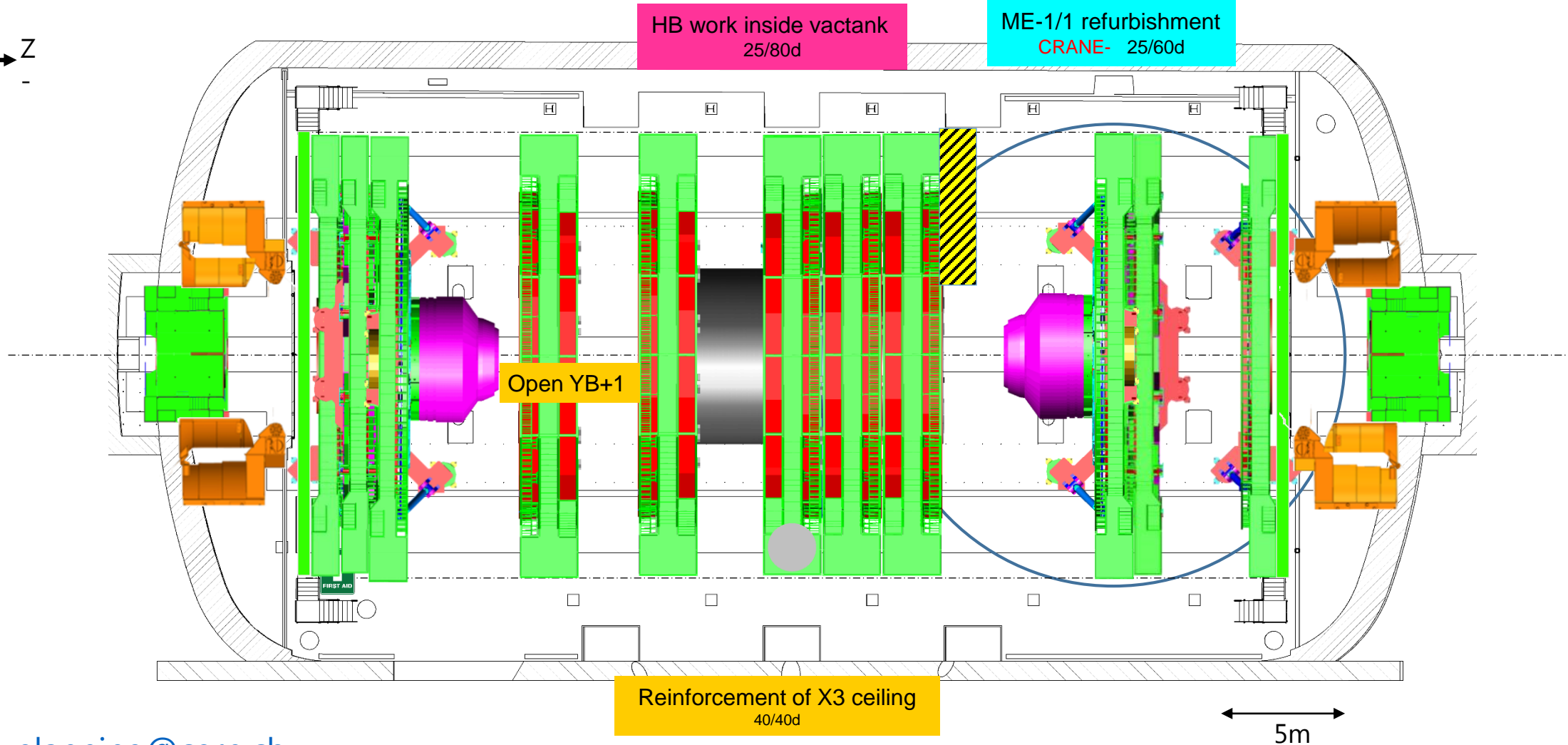
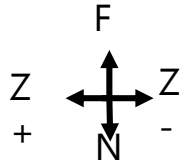



Crane

Cryo.	EL power	Water cool.	Database				
IT	Magnet	C6F14	Gas				
SL. 0	GEM	ECAL	ZEC	DT+ RB	Survey	TE-VSC	SMB
CP. 0	TOTEM	CMX	CSC RE	TK PIX	HCAL	EN Dept	RP

PX56 Plug OPEN
TX54 Plug OPEN

Saturday
30. March 2019

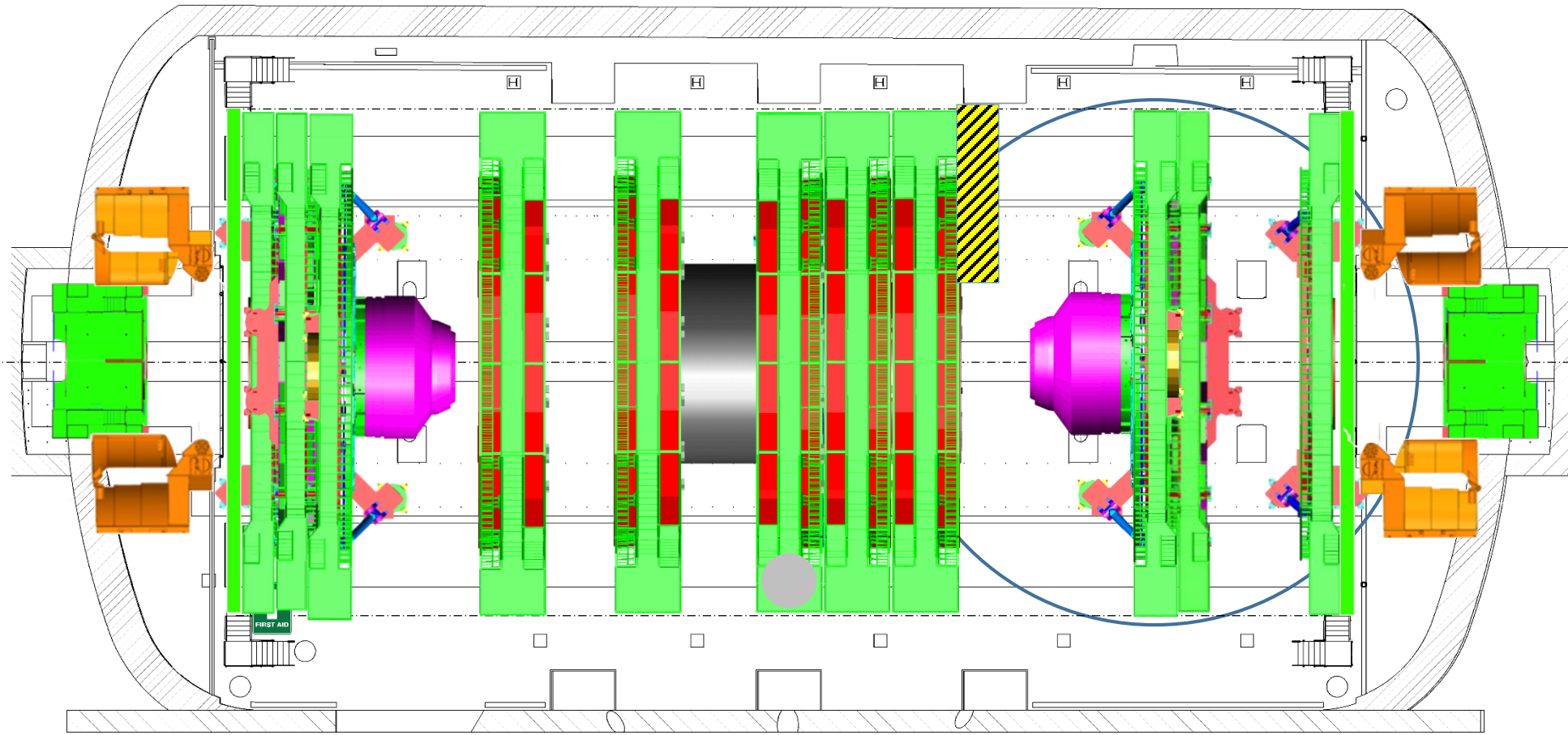
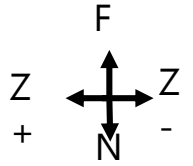

5m



Crane

Cryo.	EL power	Water cool.	Database				
IT	Magnet	C6F14	Gas				
SL. 0	GEM	ECAL	ZEC	DT+ RB	Survey	TE-VSC	SMB
CP. 0	TOTEM	CMX	CSC RE	TK PIX	HCAL	EN Dept	RP

PX56 Plug OPEN

Sunday

TX54 Plug OPEN

31. March 2019

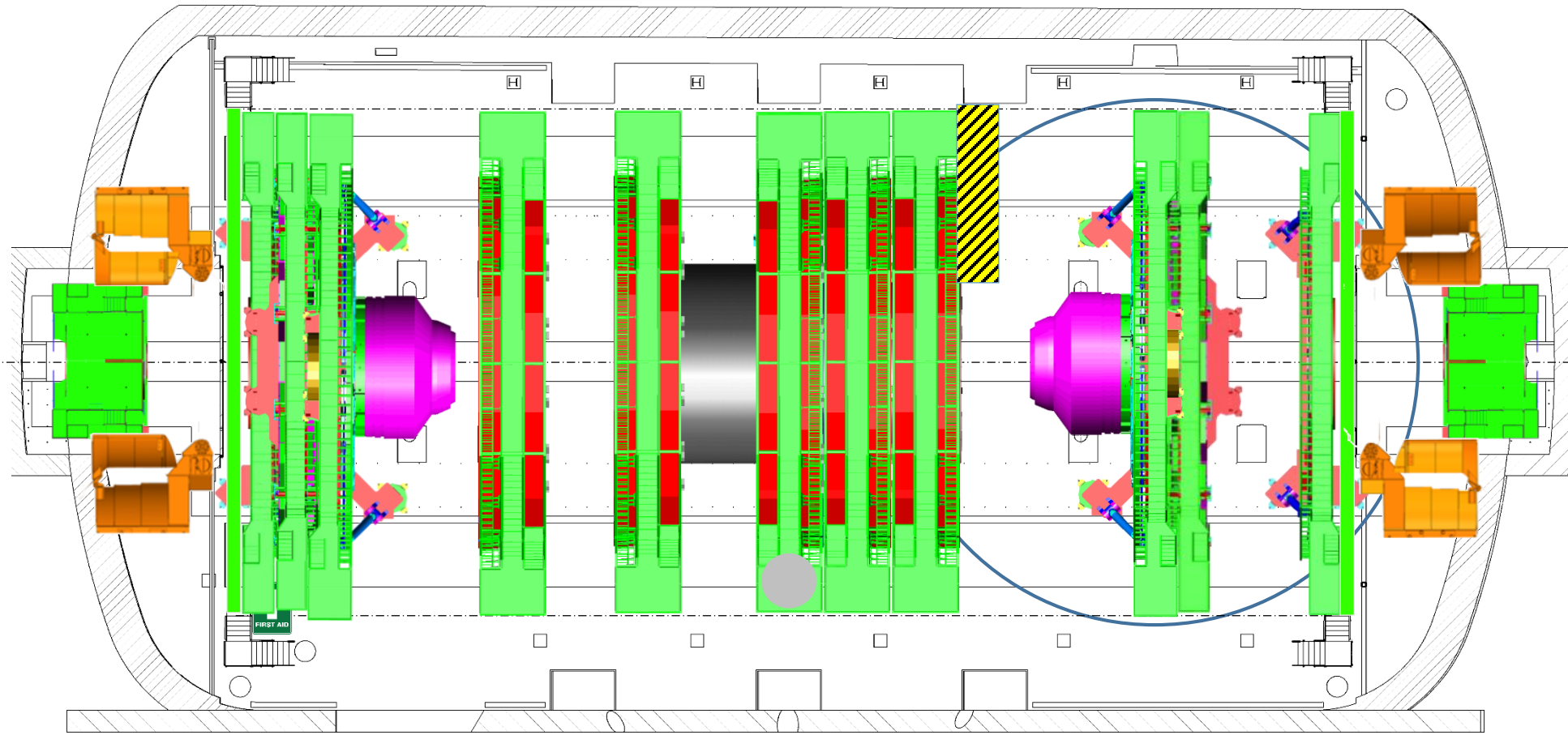
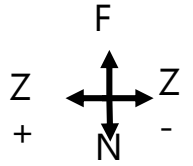

5m



Crane

Cryo.	EL power	Water cool.	Database				
IT	Magnet	C6F14	Gas				
SL. 0	GEM	ECAL	ZEC	DT+ RB	Survey	TE-VSC	SMB
CP. 0	TOTEM	CMX	CSC RE	TK PIX	HCAL	EN Dept	RP

PX56 Plug OPEN
TX54 Plug OPEN

Monday
01. April 2019

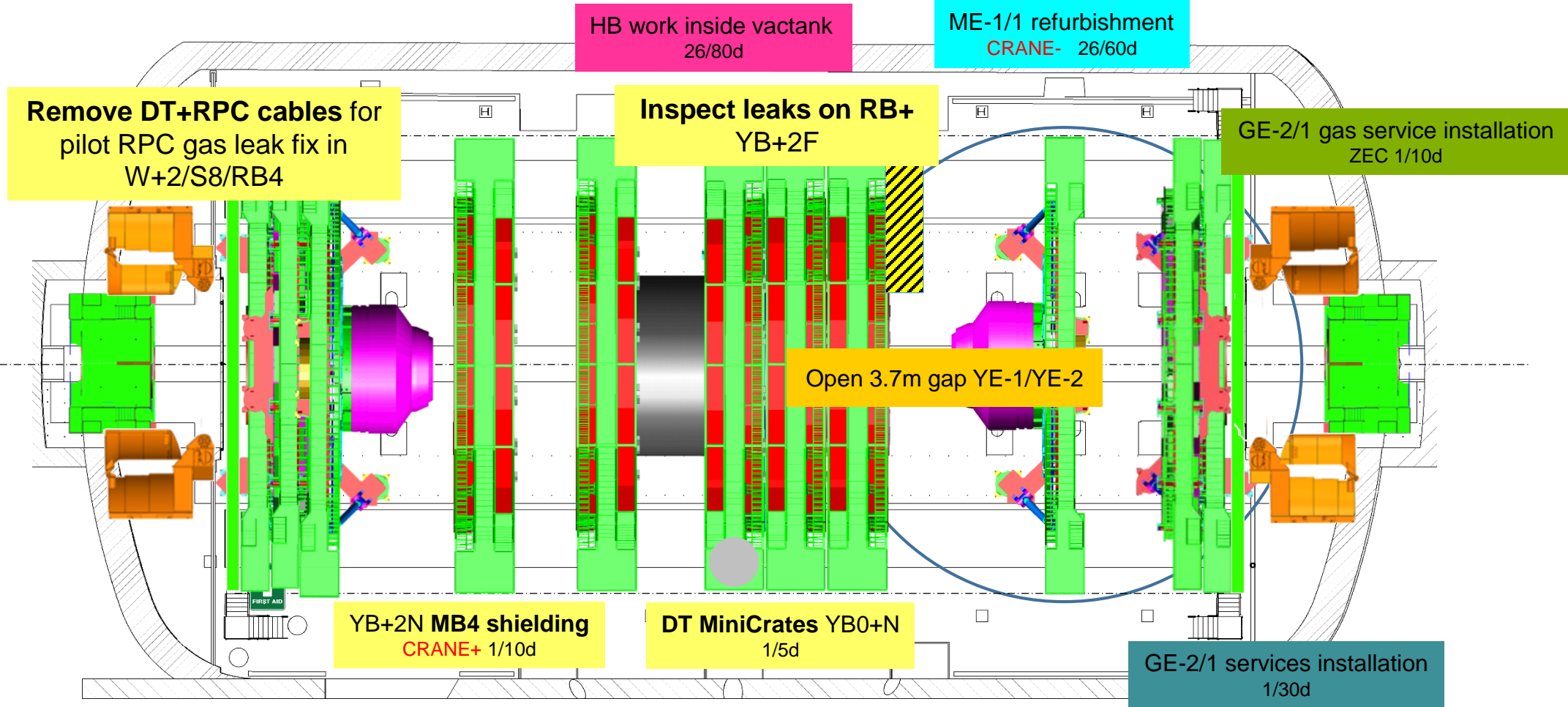
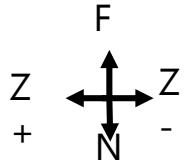

5m



Crane

Cryo.	EL power	Water cool.	Database				
IT	Magnet	C6F14	Gas				
SL. 0	GEM	ECAL	ZEC	DT+ RB	Survey	TE-VSC	SMB
CP. 0	TOTEM	CMX	CSC RE	TK PIX	HCAL	EN Dept	RP

PX56 Plug OPEN

Tuesday

TX54 Plug OPEN

02. April 2019

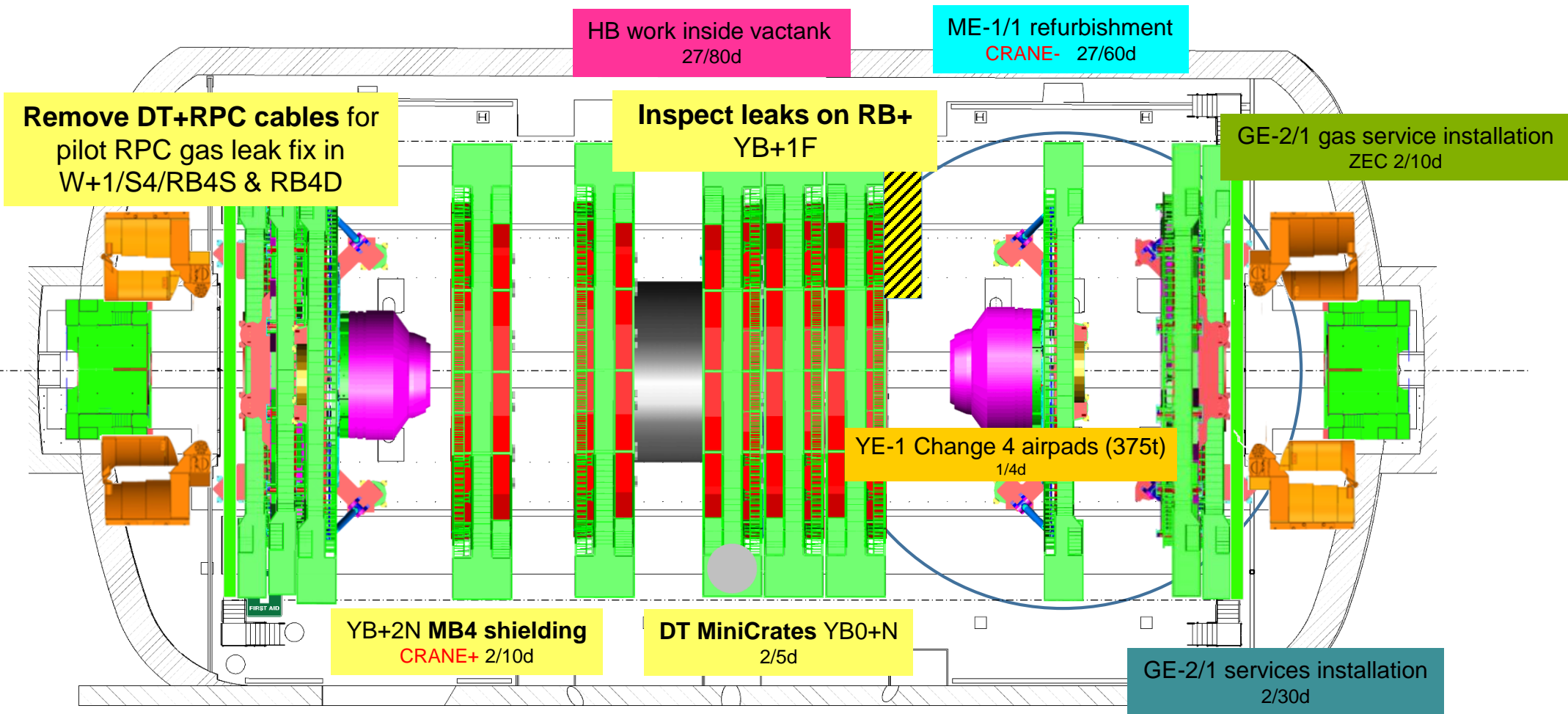
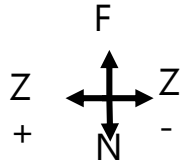

5m



Crane

Cryo.	EL power	Water cool.	Database				
IT	Magnet	C6F14	Gas				
SL. 0	GEM	ECAL	ZEC	DT+ RB	Survey	TE-VSC	SMB
CP. 0	TOTEM	CMX	CSC RE	TK PIX	HCAL	EN Dept	RP

PX56 Plug OPEN

Wednesday

TX54 Plug OPEN

03. April 2019

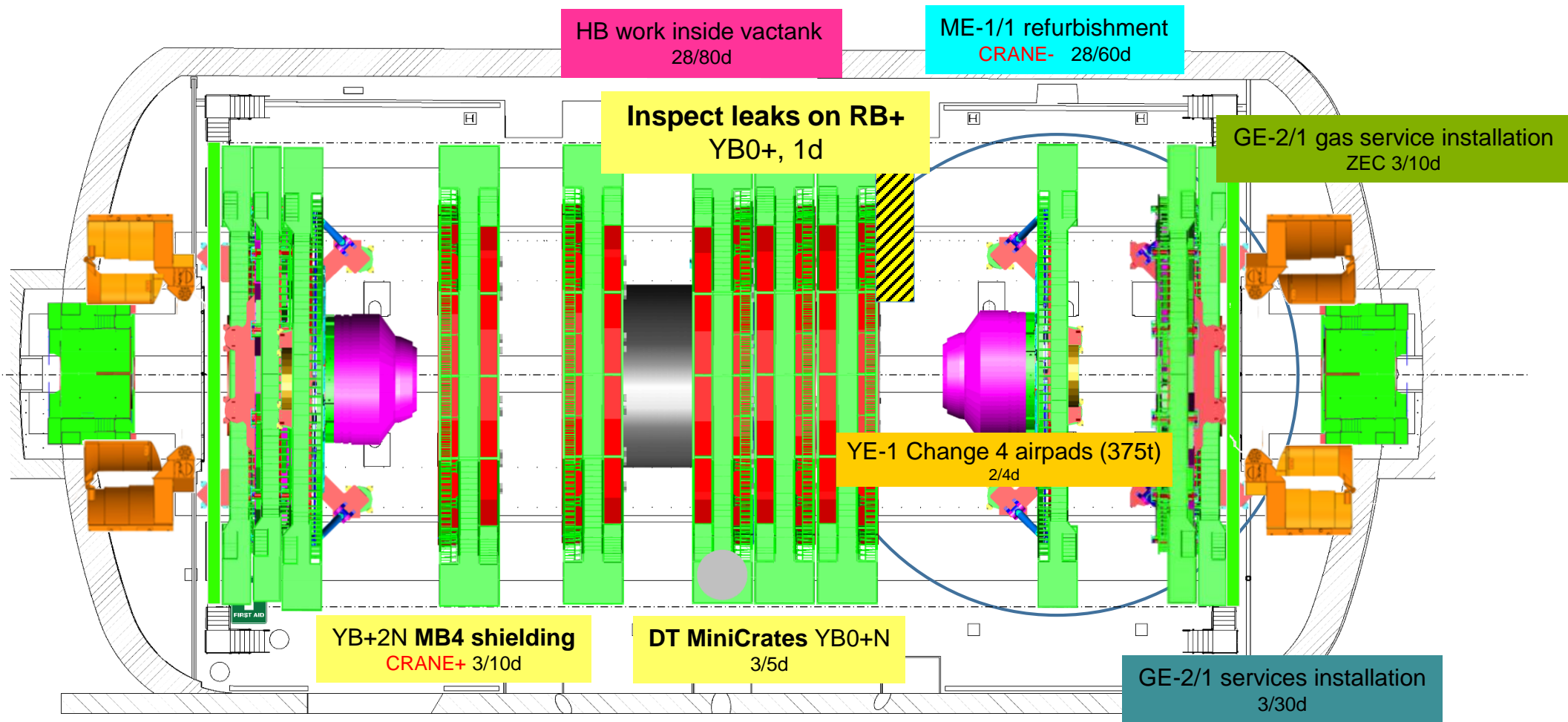
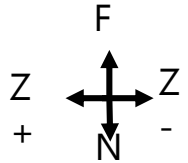

5m



Crane

Cryo.	EL power	Water cool.	Database				
IT	Magnet	C6F14	Gas				
SL. 0	GEM	ECAL	ZEC	DT+ RB	Survey	TE-VSC	SMB
CP. 0	TOTEM	CMX	CSC RE	TK PIX	HCAL	EN Dept	RP

PX56 Plug
OPEN

Thursday

TX54 Plug
OPEN

04. April 2019

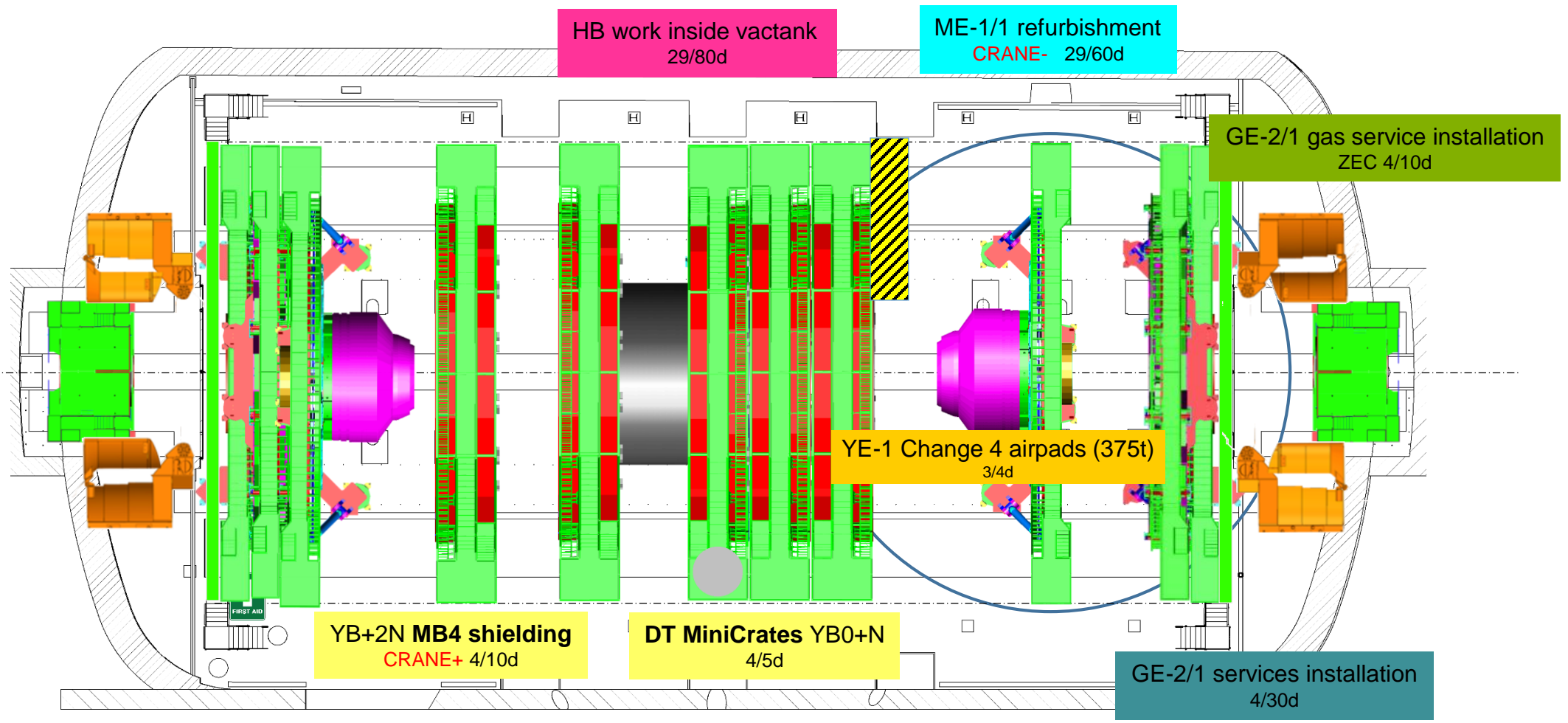
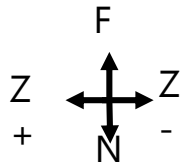

5m



Crane

Cryo.	EL power	Water cool.	Database				
IT	Magnet	C6F14	Gas				
SL. 0	GEM	ECAL	ZEC	DT+ RB	Survey	TE-VSC	SMB
CP. 0	TOTEM	CMX	CSC RE	TK PIX	HCAL	EN Dept	RP

PX56 Plug
OPEN

TX54 Plug
OPEN

Friday

05. April 2019

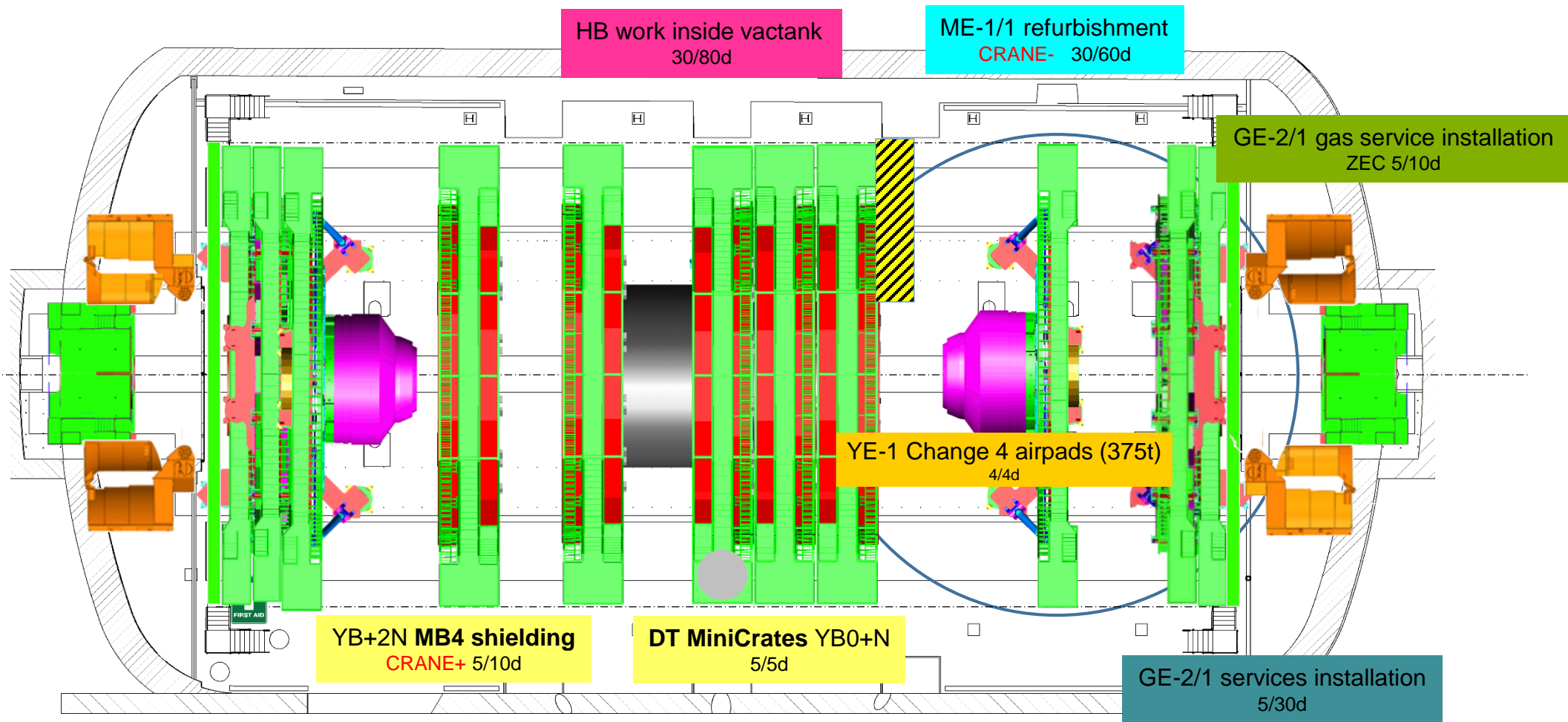
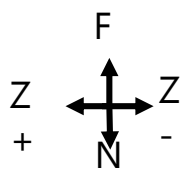

5m



Crane

Cryo.	EL power	Water cool.	Database				
IT	Magnet	C6F14	Gas				
SL. 0	GEM	ECAL	ZEC	DT+ RB	Survey	TE-VSC	SMB
CP. 0	TOTEM	CMX	CSC RE	TK PIX	HCAL	EN Dept	RP

PX56 Plug OPEN

Saturday

TX54 Plug OPEN

06. April 2019

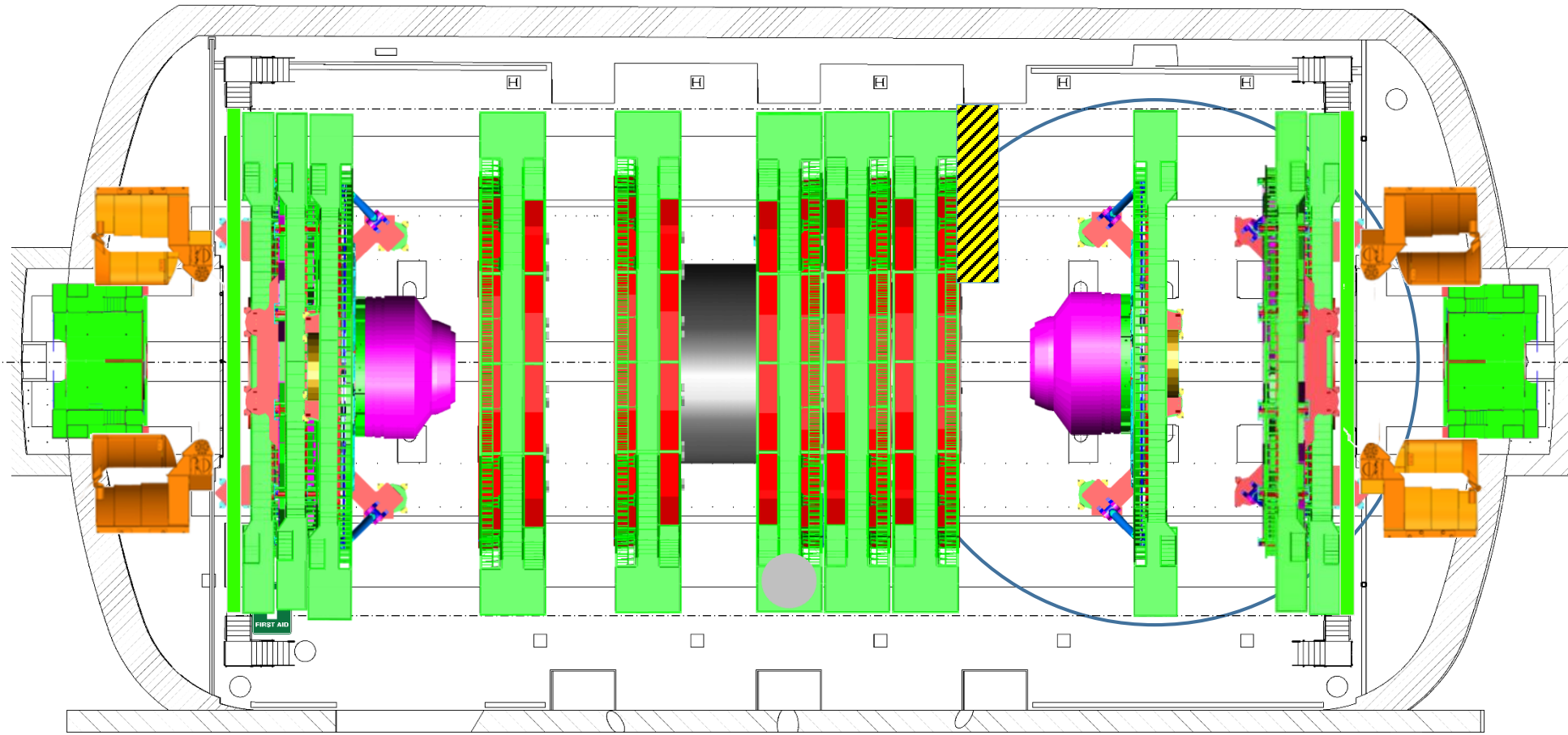
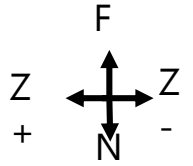

5m



Crane

Cryo.	EL power	Water cool.	Database				
IT	Magnet	C6F14	Gas				
SL. 0	GEM	ECAL	ZEC	DT+ RB	Survey	TE-VSC	SMB
CP. 0	TOTEM	CMX	CSC RE	TK PIX	HCAL	EN Dept	RP

PX56 Plug OPEN
TX54 Plug OPEN

Sunday
07. April 2019

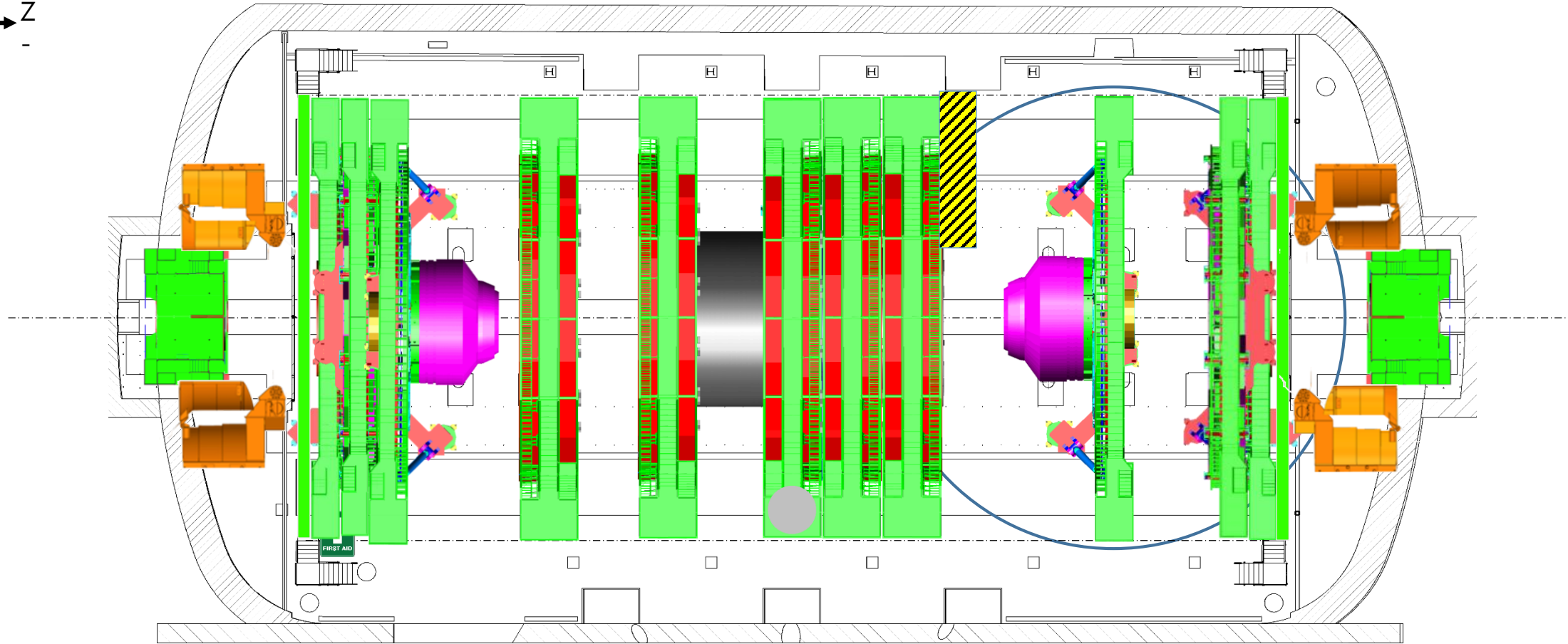
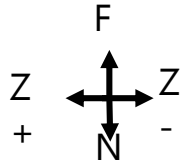

5m



Crane

Cryo.	EL power	Water cool.	Database				
IT	Magnet	C6F14	Gas				
SL. 0	GEM	ECAL	ZEC	DT+ RB	Survey	TE-VSC	SMB
CP. 0	TOTEM	CMX	CSC RE	TK PIX	HCAL	EN Dept	RP

PX56 Plug
OPEN

Monday

TX54 Plug
OPEN

08. April 2019

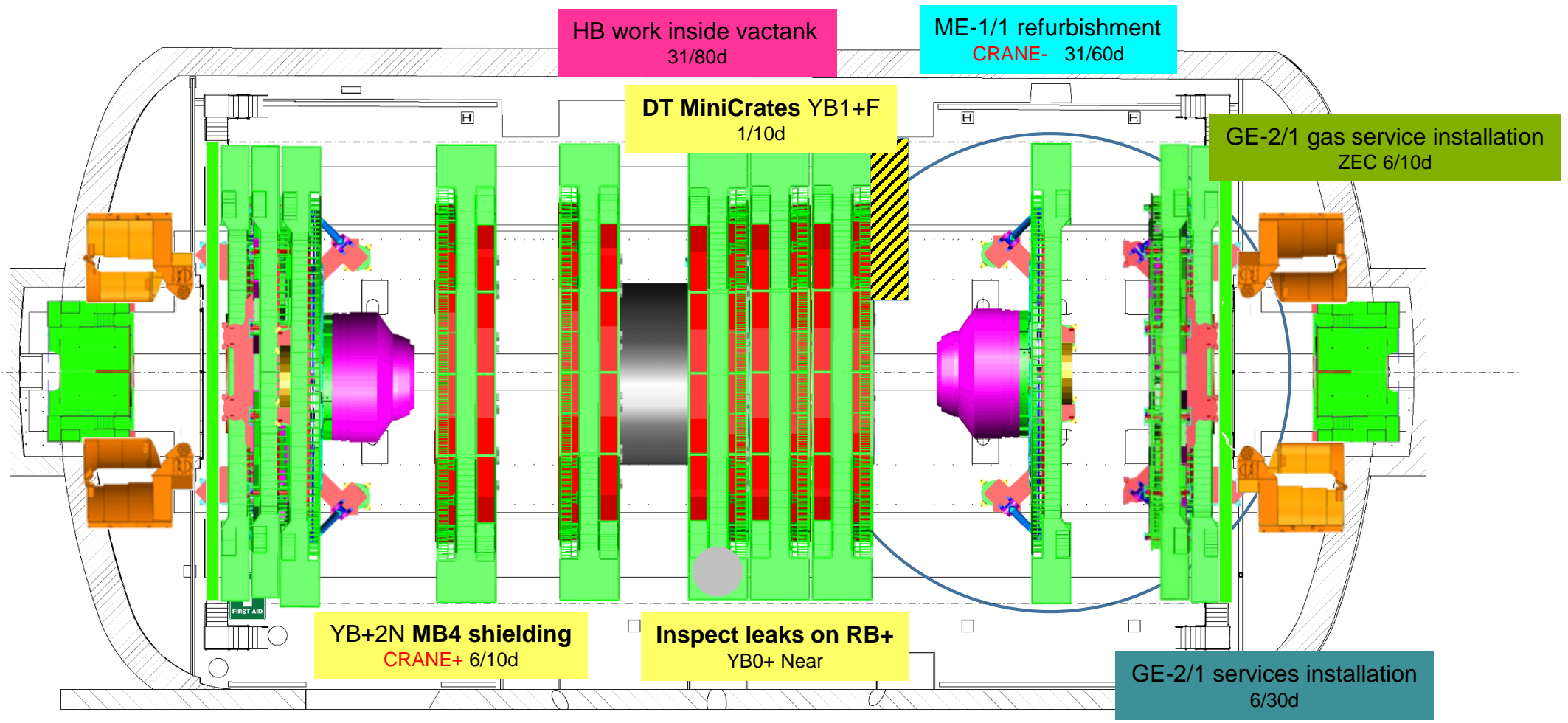
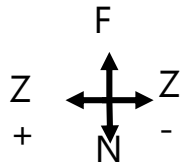

5m



Crane

Cryo.	EL power	Water cool.	Database				
IT	Magnet	C6F14	Gas				
SL. 0	GEM	ECAL	ZEC	DT+ RB	Survey	TE-VSC	SMB
CP. 0	TOTEM	CMX	CSC RE	TK PIX	HCAL	EN Dept	RP

PX56 Plug
OPEN

Tuesday

TX54 Plug
OPEN

09. April 2019

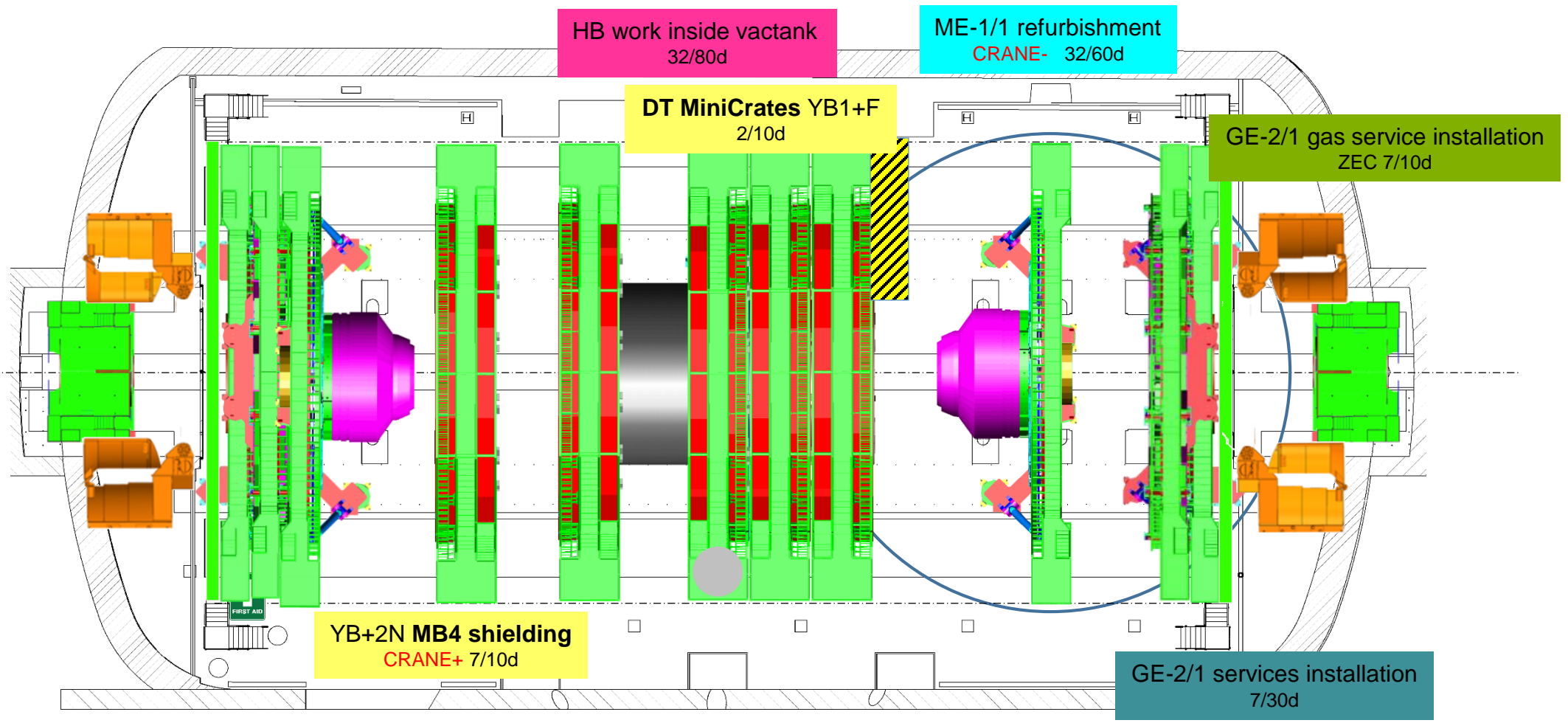
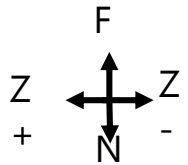

5m



Crane

Cryo.	EL power	Water cool.	Database				
IT	Magnet	C6F14	Gas				
SL. 0	GEM	ECAL	ZEC	DT+ RB	Survey	TE-VSC	SMB
CP. 0	TOTEM	CMX	CSC RE	TK PIX	HCAL	EN Dept	RP

PX56 Plug OPEN
TX54 Plug OPEN

Wednesday
10. April 2019

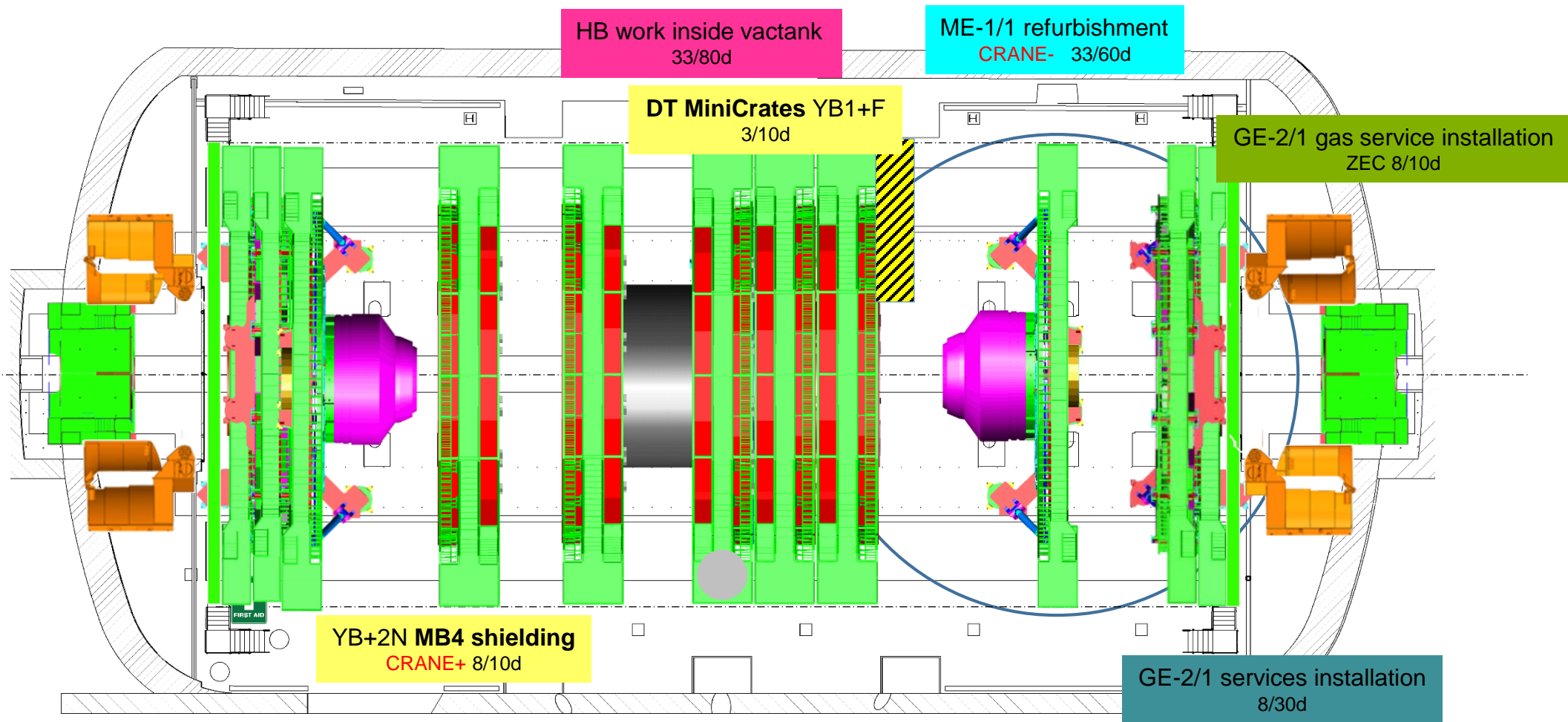

5m



Crane

Cryo.	EL power	Water cool.	Database				
IT	Magnet	C6F14	Gas				
SL. 0	GEM	ECAL	ZEC	DT+ RB	Survey	TE-VSC	SMB
CP. 0	TOTEM	CMX	CSC RE	TK PIX	HCAL	EN Dept	RP

PX56 Plug OPEN
TX54 Plug OPEN

Thursday
11. April 2019

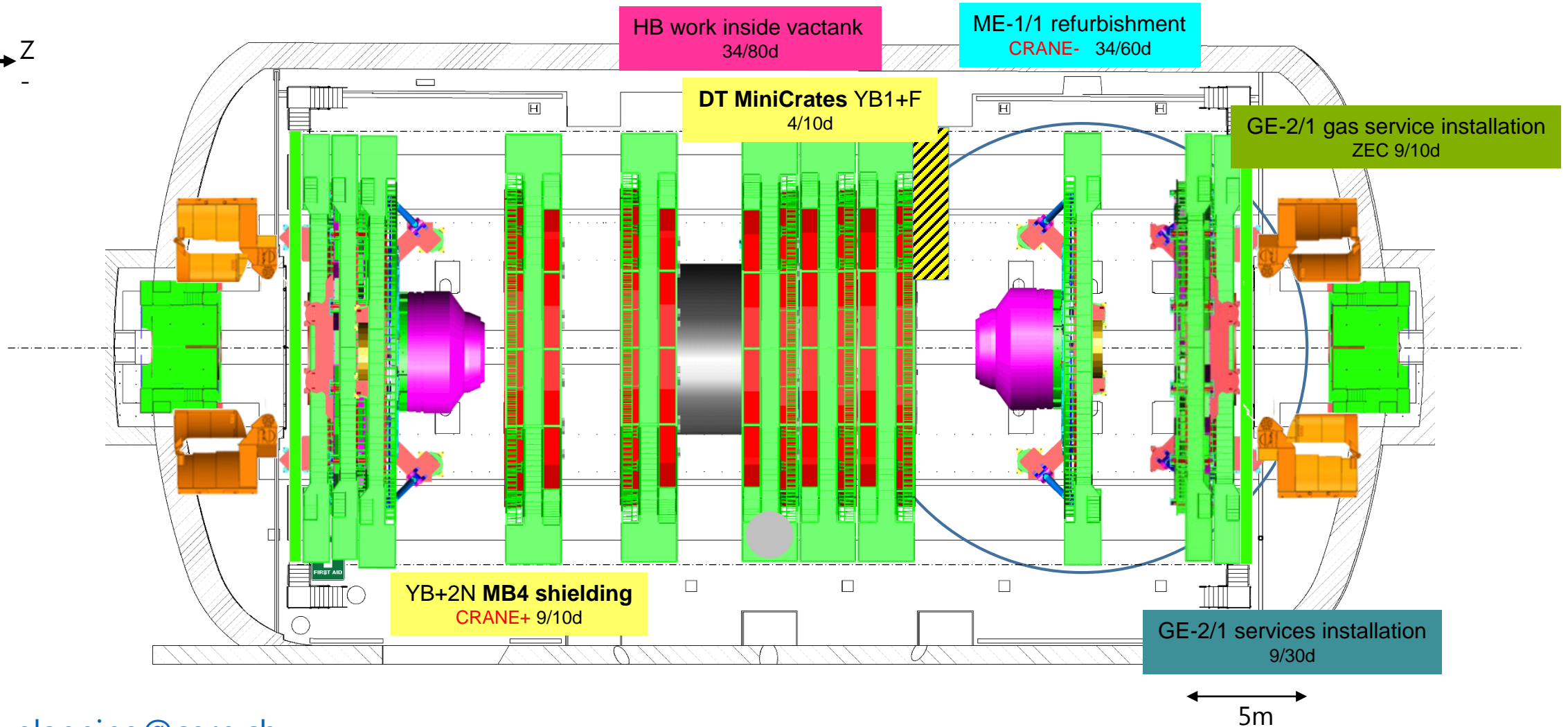
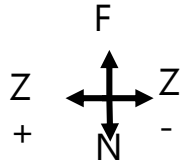



Crane

Cryo.	EL power	Water cool.	Database				
IT	Magnet	C6F14	Gas				
SL. 0	GEM	ECAL	ZEC	DT+ RB	Survey	TE-VSC	SMB
CP. 0	TOTEM	CMX	CSC RE	TK PIX	HCAL	EN Dept	RP

PX56 Plug
OPEN

TX54 Plug
OPEN

Friday

12. April 2019

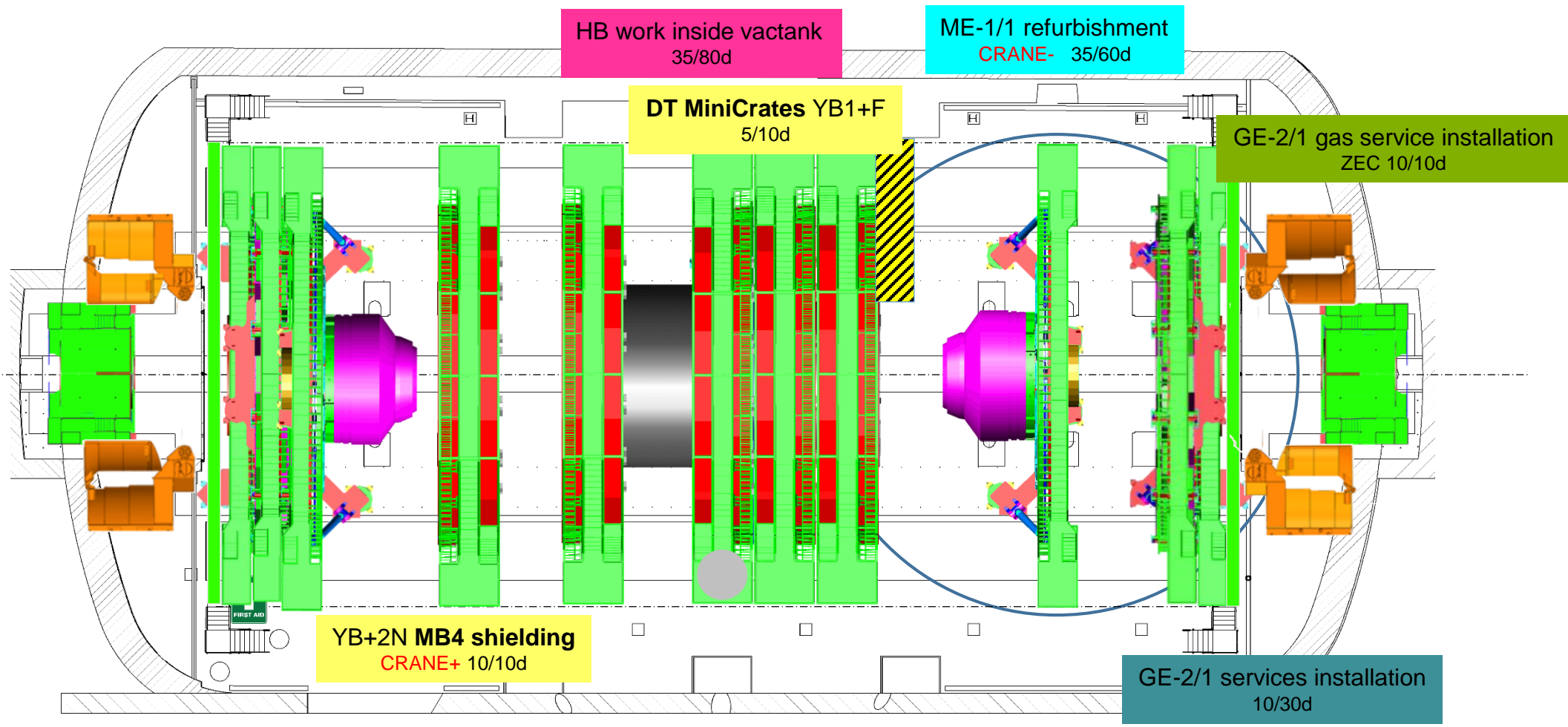
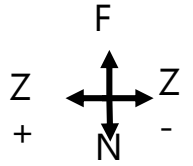

GE-2/1 services installation
10/30d

5m



Crane

Cryo.	EL power	Water cool.	Database				
IT	Magnet	C6F14	Gas				
SL. 0	GEM	ECAL	ZEC	DT+ RB	Survey	TE-VSC	SMB
CP. 0	TOTEM	CMX	CSC RE	TK PIX	HCAL	EN Dept	RP

PX56 Plug OPEN
TX54 Plug OPEN

Saturday
13. April 2019

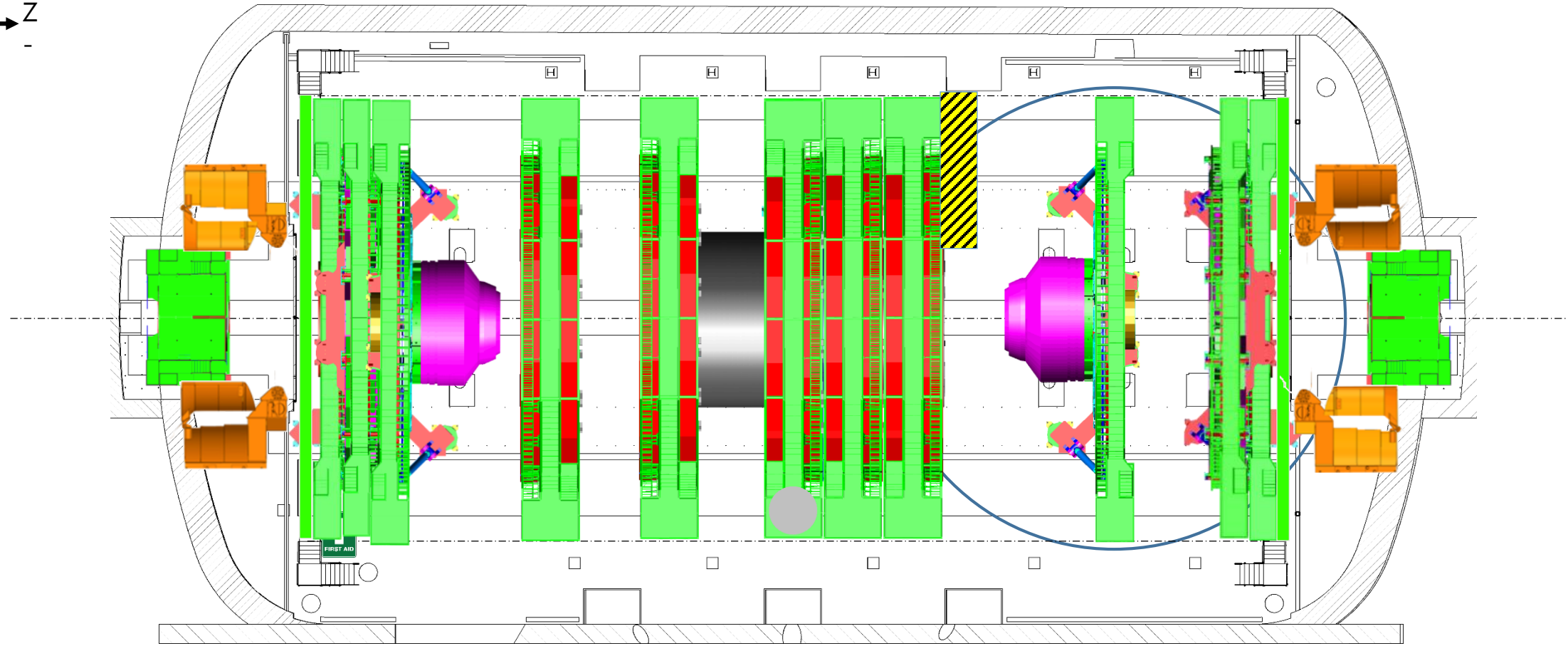
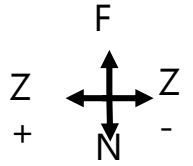

5m



Crane

Cryo.	■	EL power	■	Water cool.	■	Database	■	
IT	■	Magnet	■	C6F14	■	Gas	■	
SL.	0	GEM	ECAL	ZEC	DT+ RB	Survey	TE-VSC	SMB
CP.	0	TOTEM	CMX	CSC RE	TK PIX	HCAL	EN Dept	RP

PX56 Plug OPEN

Sunday

TX54 Plug OPEN

14. April 2019

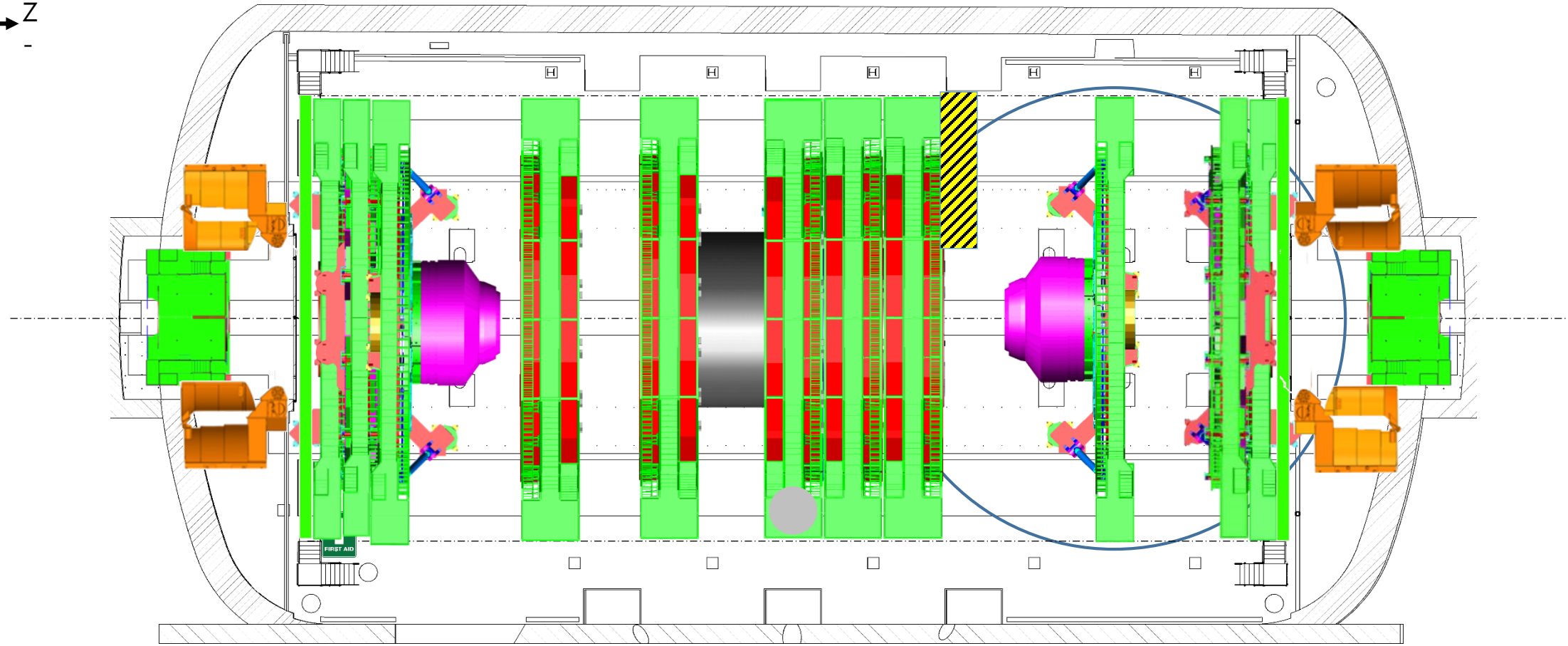
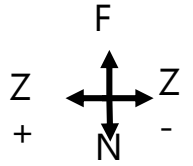

5m



Crane

Cryo.	EL power	Water cool.	Database				
IT	Magnet	C6F14	Gas				
SL. 0	GEM	ECAL	ZEC	DT+ RB	Survey	TE-VSC	SMB
CP. 0	TOTEM	CMX	CSC RE	TK PIX	HCAL	EN Dept	RP

PX56 Plug
OPEN

TX54 Plug
OPEN

Monday

15. April 2019

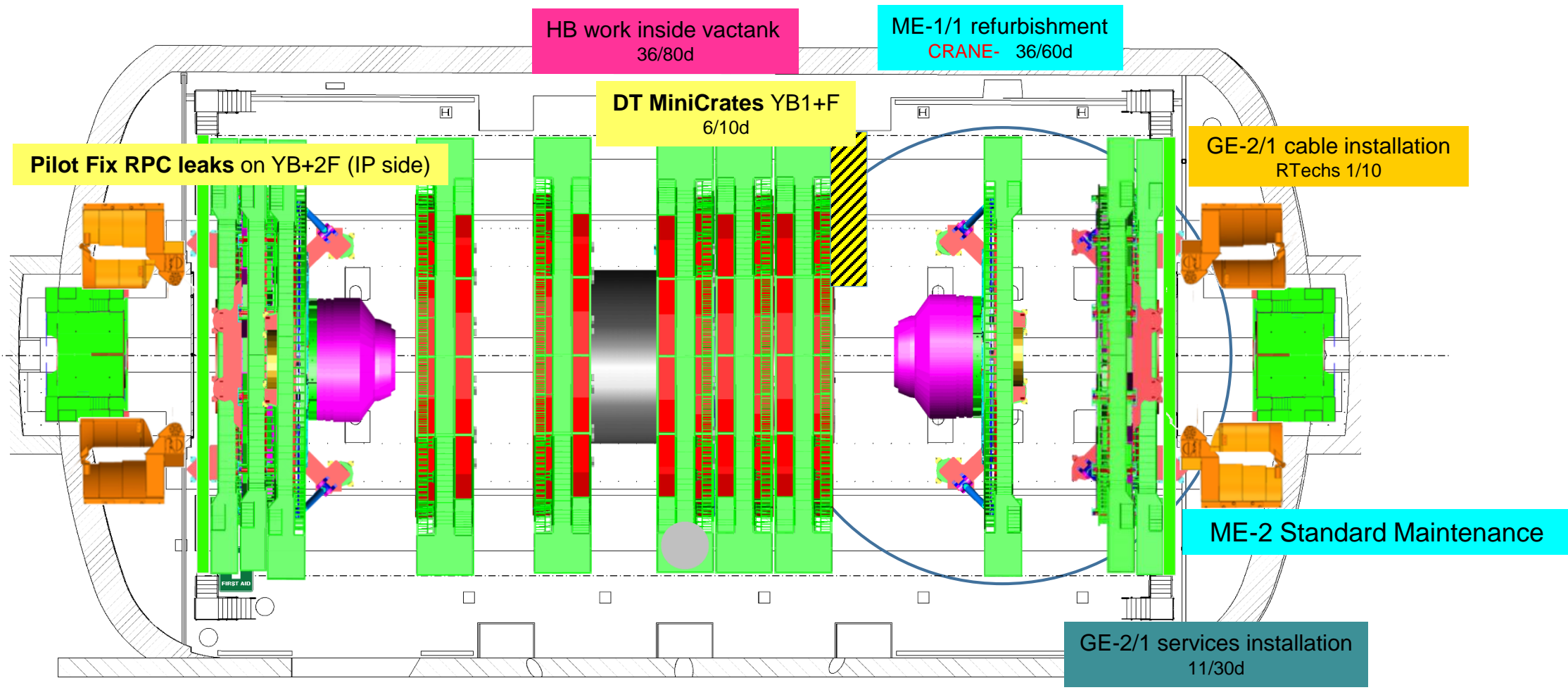

5m



Crane

Cryo.	EL power	Water cool.	Database				
IT	Magnet	C6F14	Gas				
SL. 0	GEM	ECAL	ZEC	DT+ RB	Survey	TE-VSC	SMB
CP. 0	TOTEM	CMX	CSC RE	TK PIX	HCAL	EN Dept	RP

PX56 Plug
OPEN

TX54 Plug
OPEN

Tuesday

16. April 2019

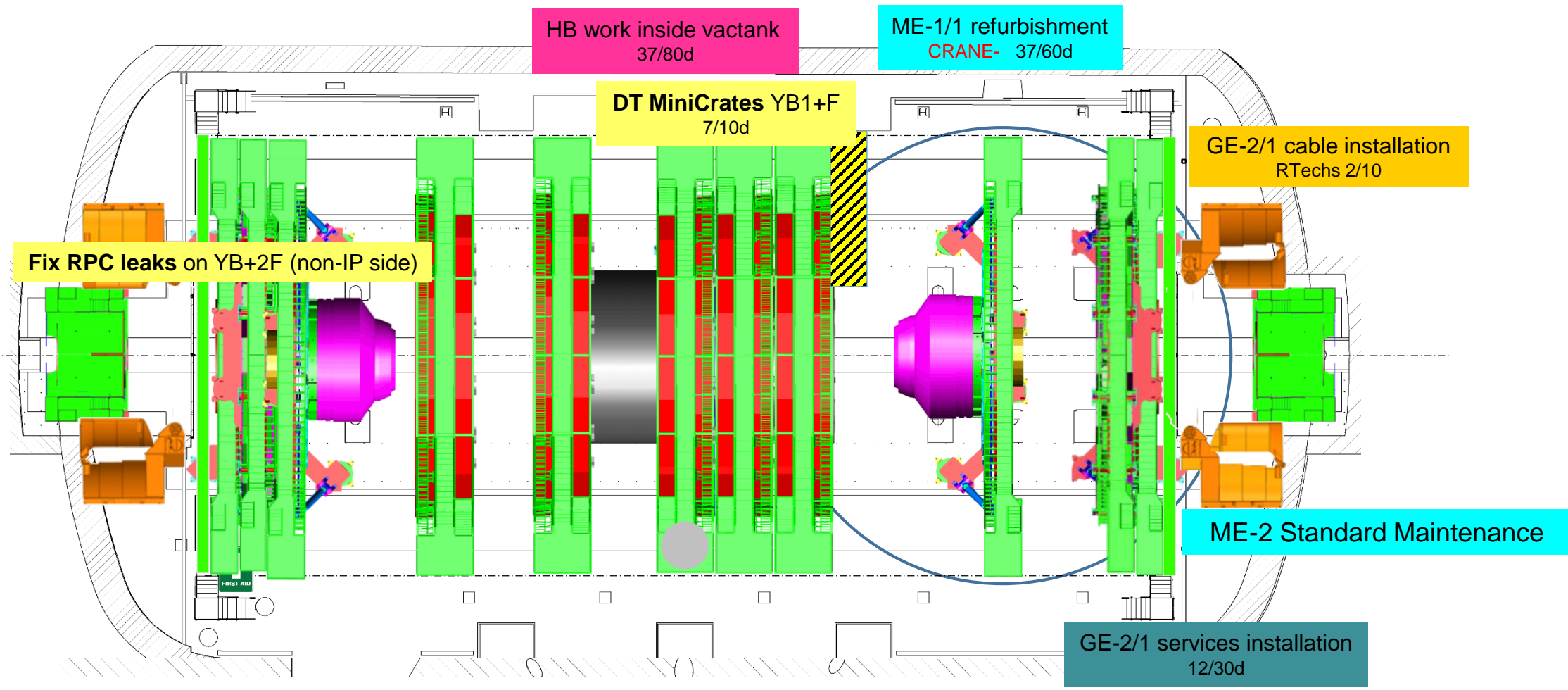
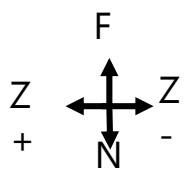



Crane

Cryo.	EL power	Water cool.	Database				
IT	Magnet	C6F14	Gas				
SL. 0	GEM	ECAL	ZEC	DT+ RB	Survey	TE-VSC	SMB
CP. 0	TOTEM	CMX	CSC RE	TK PIX	HCAL	EN Dept	RP

PX56 Plug
OPEN

TX54 Plug
OPEN

Wednesday

17. April 2019

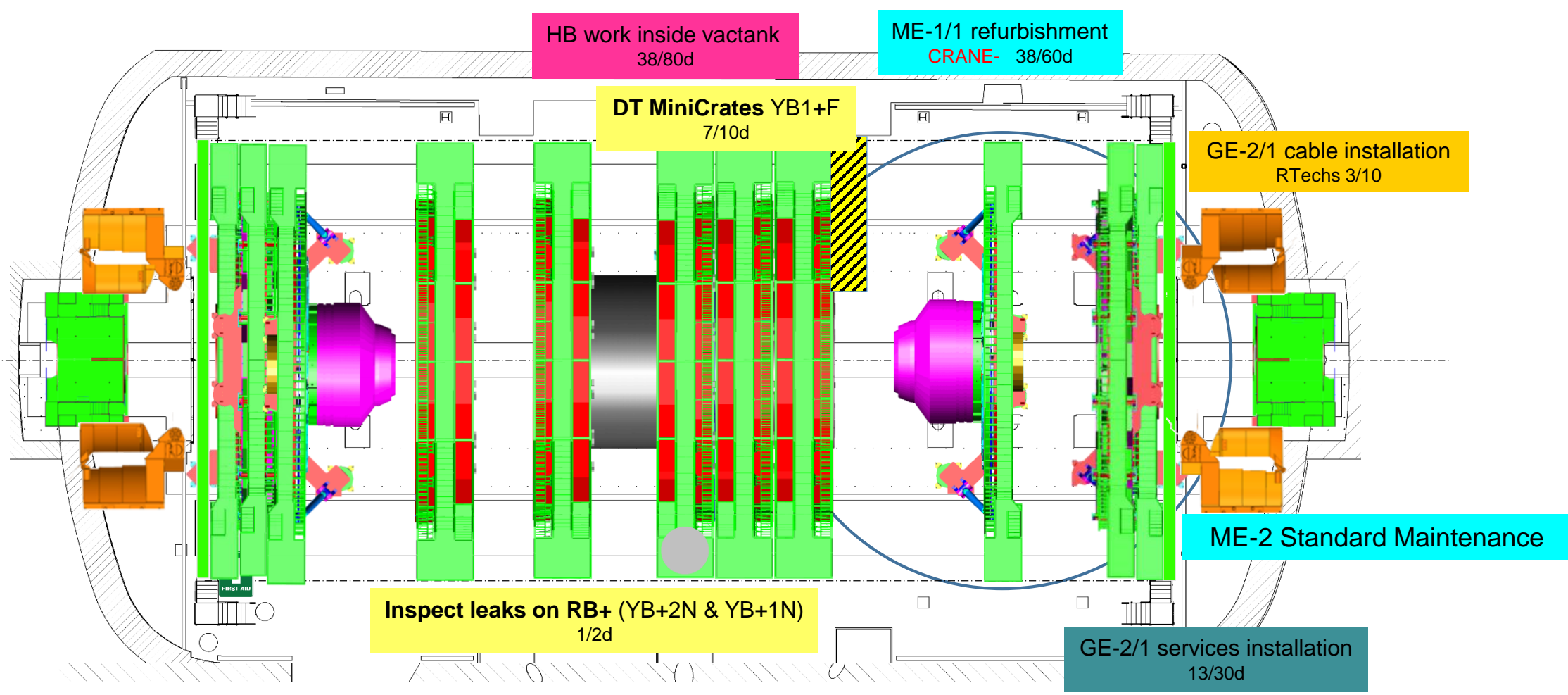
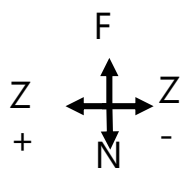

5m



Crane

Cryo.	EL power	Water cool.	Database				
IT	Magnet	C6F14	Gas				
SL. 0	GEM	ECAL	ZEC	DT+ RB	Survey	TE-VSC	SMB
CP. 0	TOTEM	CMX	CSC RE	TK PIX	HCAL	EN Dept	RP

PX56 Plug OPEN

Thursday

TX54 Plug OPEN

18. April 2019

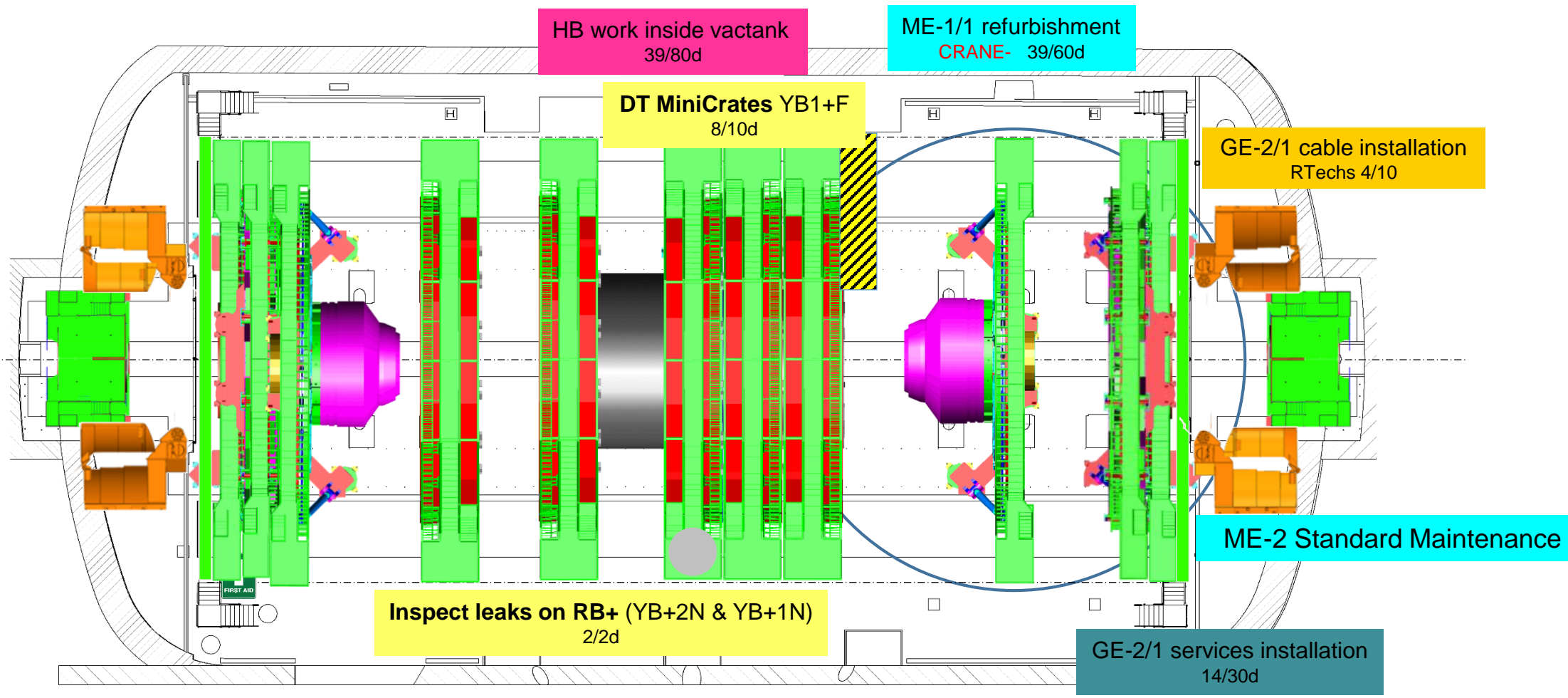
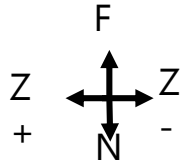

HB work inside vactank
39/80d

ME-1/1 refurbishment
CRANE- 39/60d

DT MiniCrates YB1+F
8/10d

GE-2/1 cable installation
RTechs 4/10

ME-2 Standard Maintenance

Inspect leaks on RB+ (YB+2N & YB+1N)
2/2d

GE-2/1 services installation
14/30d

5m



Crane

Cryo.	EL power	Water cool.	Database				
IT	Magnet	C6F14	Gas				
SL. 0	GEM	ECAL	ZEC	DT+ RB	Survey	TE-VSC	SMB
CP. 0	TOTEM	CMX	CSC RE	TK PIX	HCAL	EN Dept	RP

PX56 Plug OPEN
TX54 Plug OPEN

Friday
19. April 2019

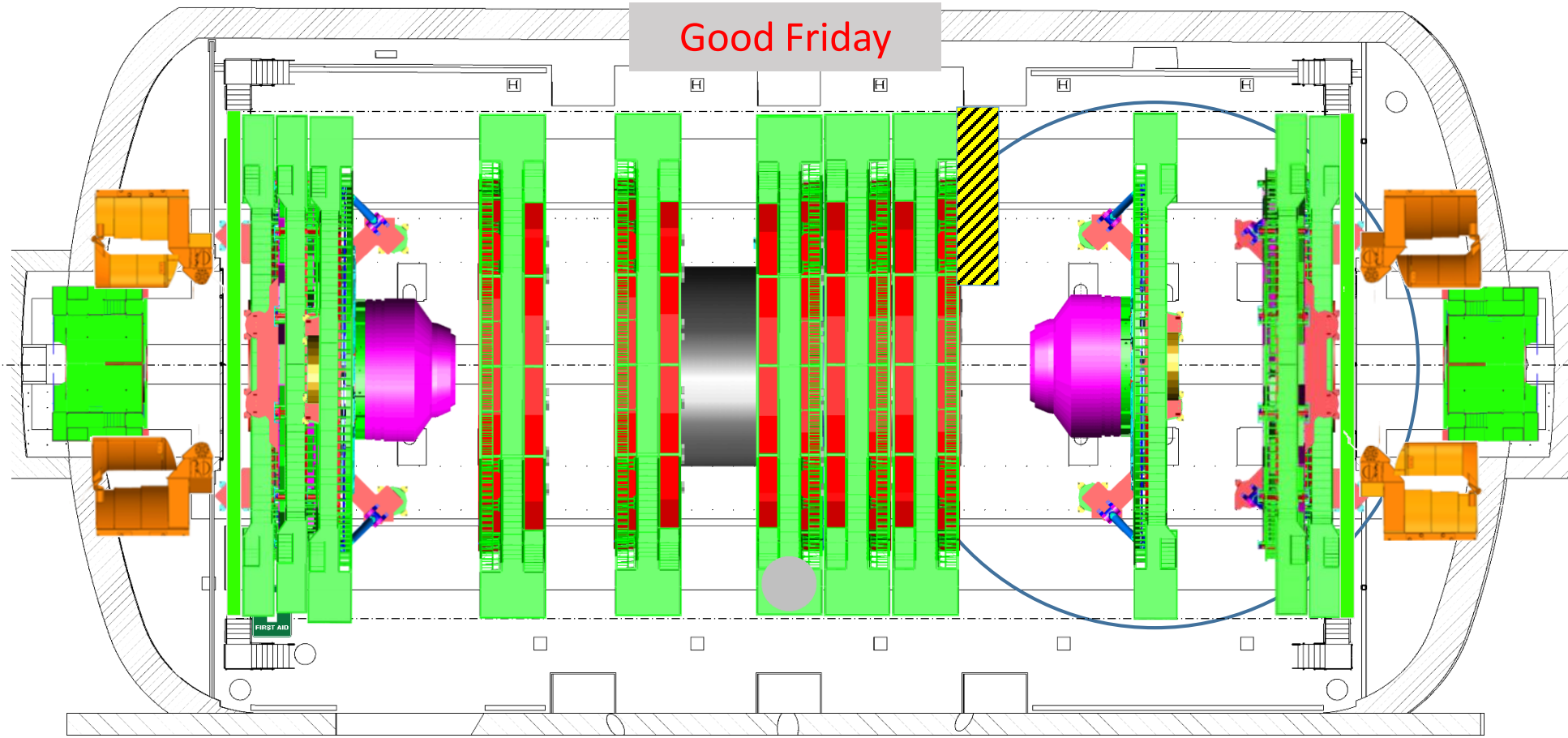
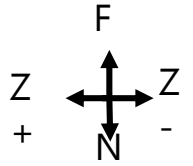

5m



Crane

Cryo.	EL power	Water cool.	Database				
IT	Magnet	C6F14	Gas				
SL. 0	GEM	ECAL	ZEC	DT+ RB	Survey	TE-VSC	SMB
CP. 0	TOTEM	CMX	CSC RE	TK PIX	HCAL	EN Dept	RP

PX56 Plug OPEN

Saturday

TX54 Plug OPEN

20. April 2019

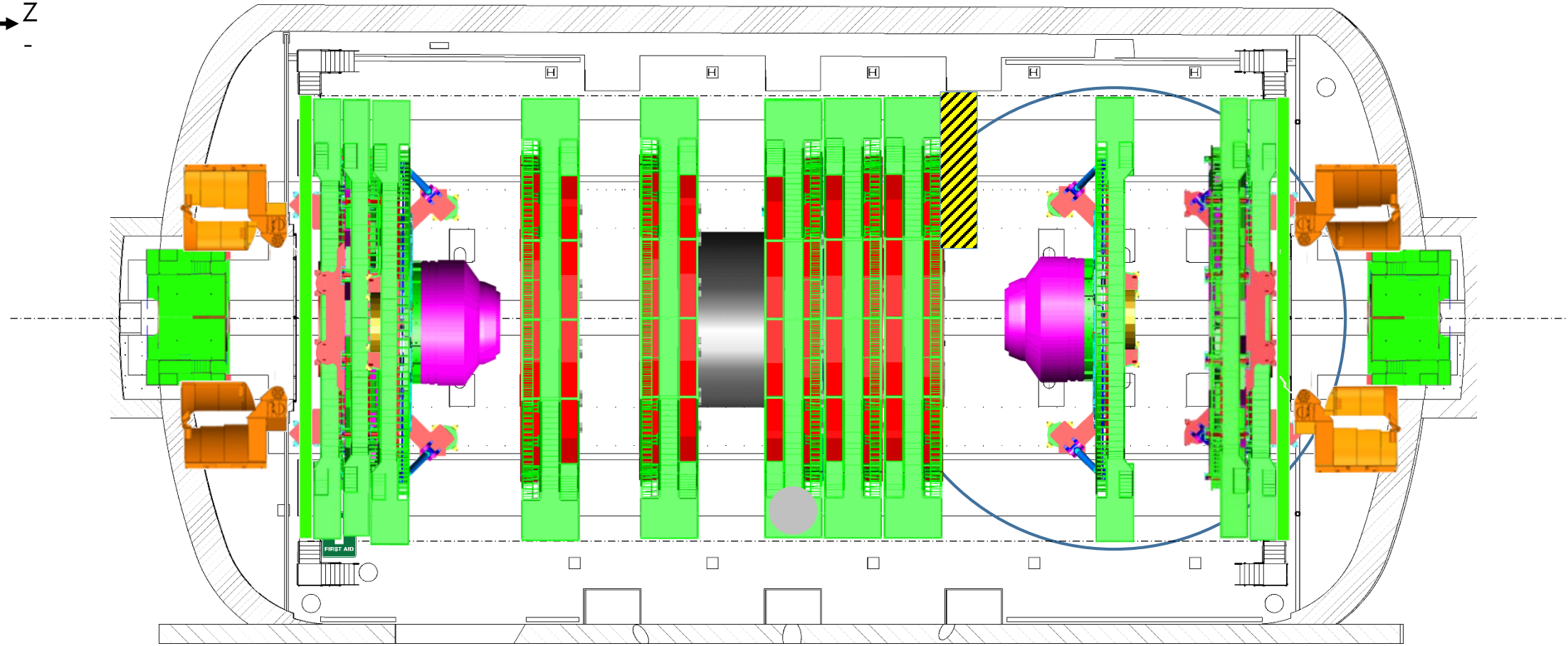
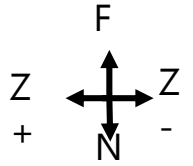

5m



Crane

Cryo.	EL power	Water cool.	Database				
IT	Magnet	C6F14	Gas				
SL. 0	GEM	ECAL	ZEC	DT+ RB	Survey	TE-VSC	SMB
CP. 0	TOTEM	CMX	CSC RE	TK PIX	HCAL	EN Dept	RP

PX56 Plug OPEN

Sunday

TX54 Plug OPEN

21. April 2019

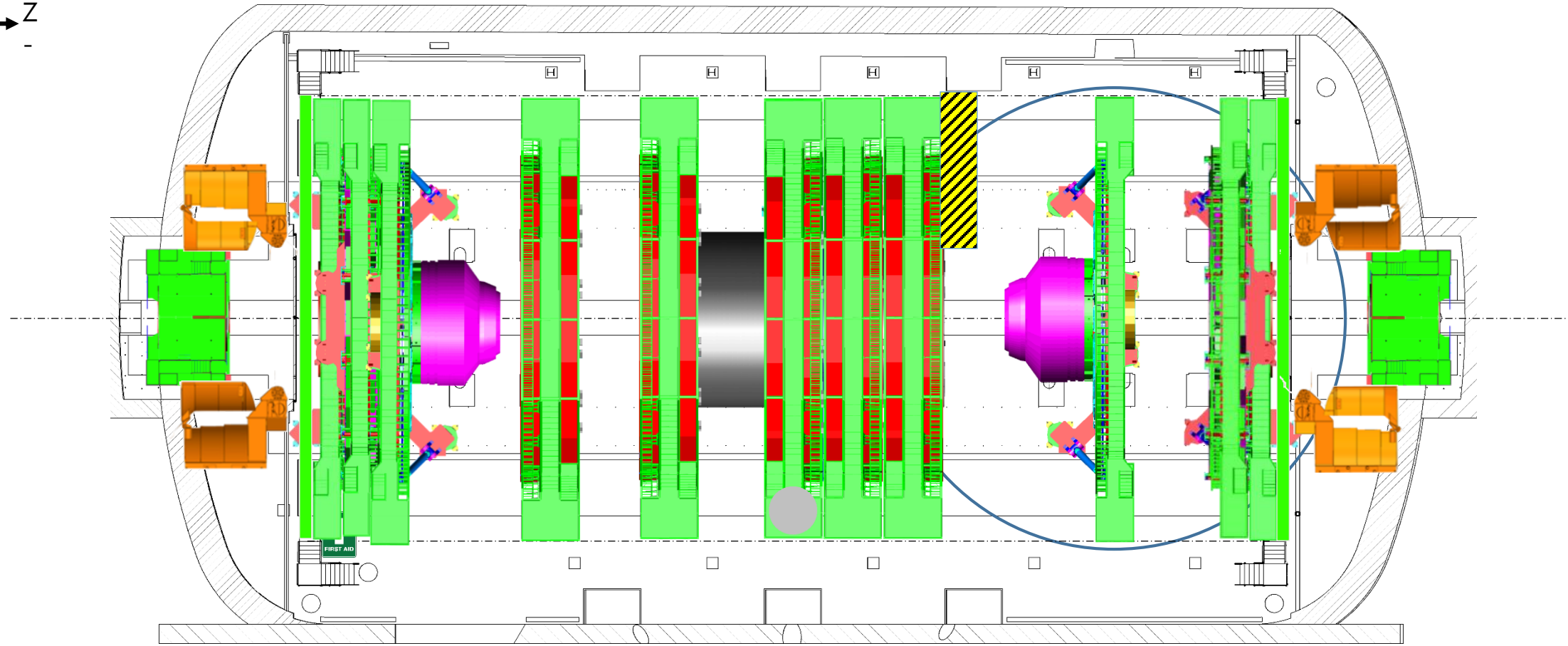
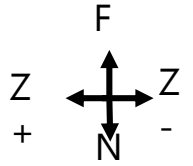

5m



Crane

Cryo.	EL power	Water cool.	Database				
IT	Magnet	C6F14	Gas				
SL. 0	GEM	ECAL	ZEC	DT+ RB	Survey	TE-VSC	SMB
CP. 0	TOTEM	CMX	CSC RE	TK PIX	HCAL	EN Dept	RP

PX56 Plug OPEN
TX54 Plug OPEN

Monday
22. April 2019

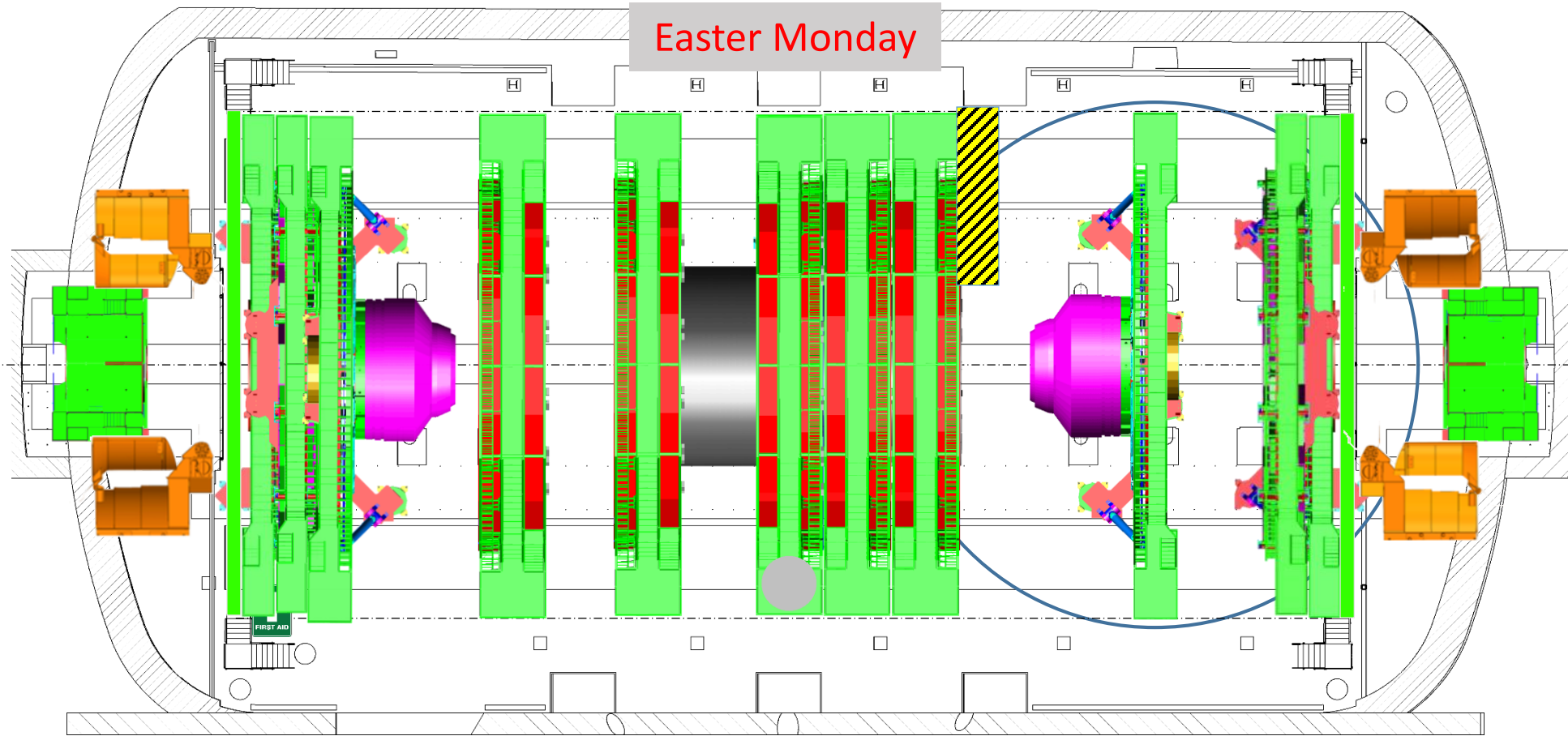
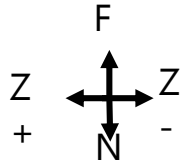

5m



Crane

Cryo.	EL power	Water cool.	Database				
IT	Magnet	C6F14	Gas				
SL. 0	GEM	ECAL	ZEC	DT+ RB	Survey	TE-VSC	SMB
CP. 0	TOTEM	CMX	CSC RE	TK PIX	HCAL	EN Dept	RP

PX56 Plug OPEN

Tuesday

TX54 Plug OPEN

23. April 2019

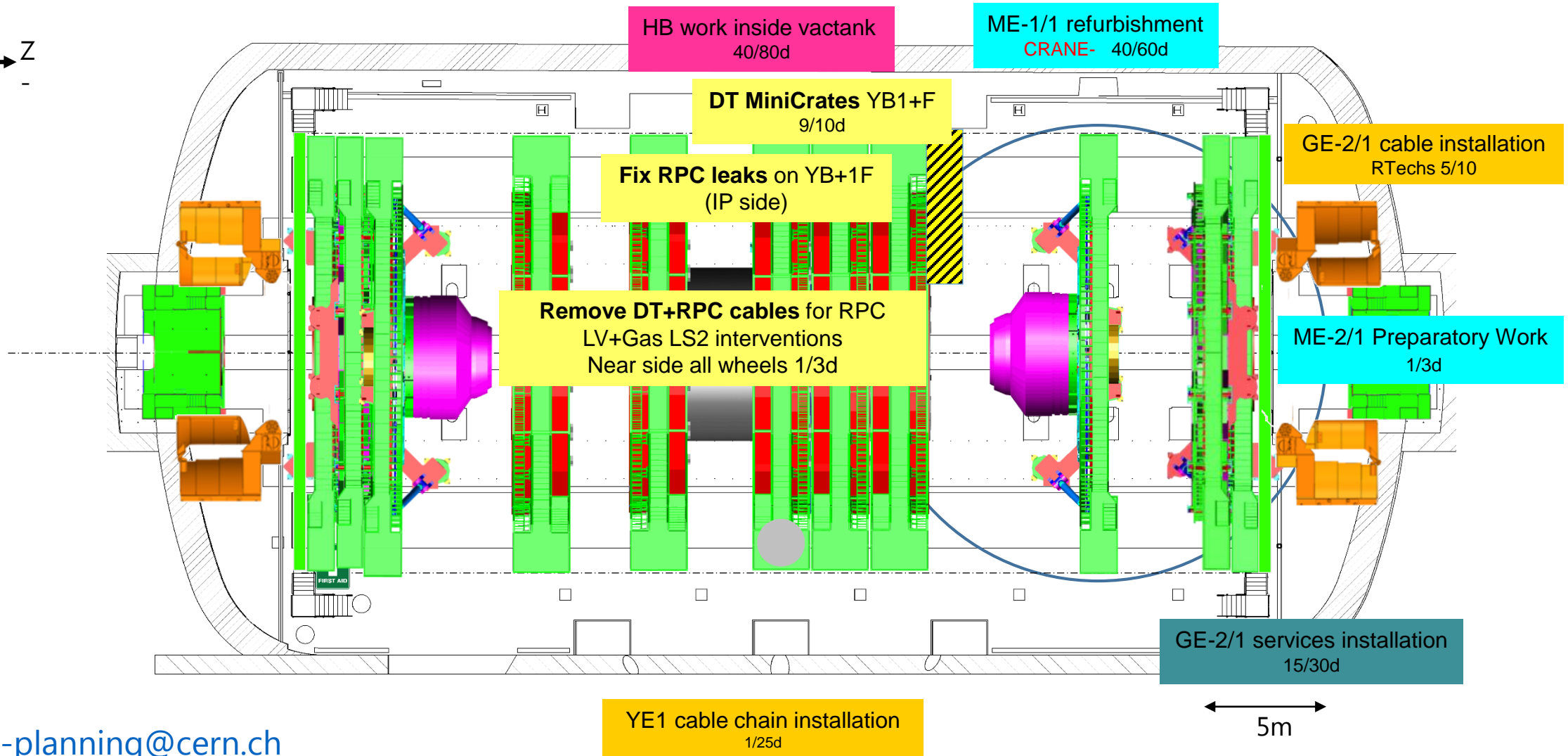
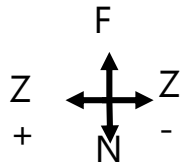



Crane

Cryo.	EL power	Water cool.	Database				
IT	Magnet	C6F14	Gas				
SL. 0	GEM	ECAL	ZEC	DT+ RB	Survey	TE-VSC	SMB
CP. 0	TOTEM	CMX	CSC RE	TK PIX	HCAL	EN Dept	RP

PX56 Plug
OPEN

TX54 Plug
OPEN

Wednesday

24. April 2019

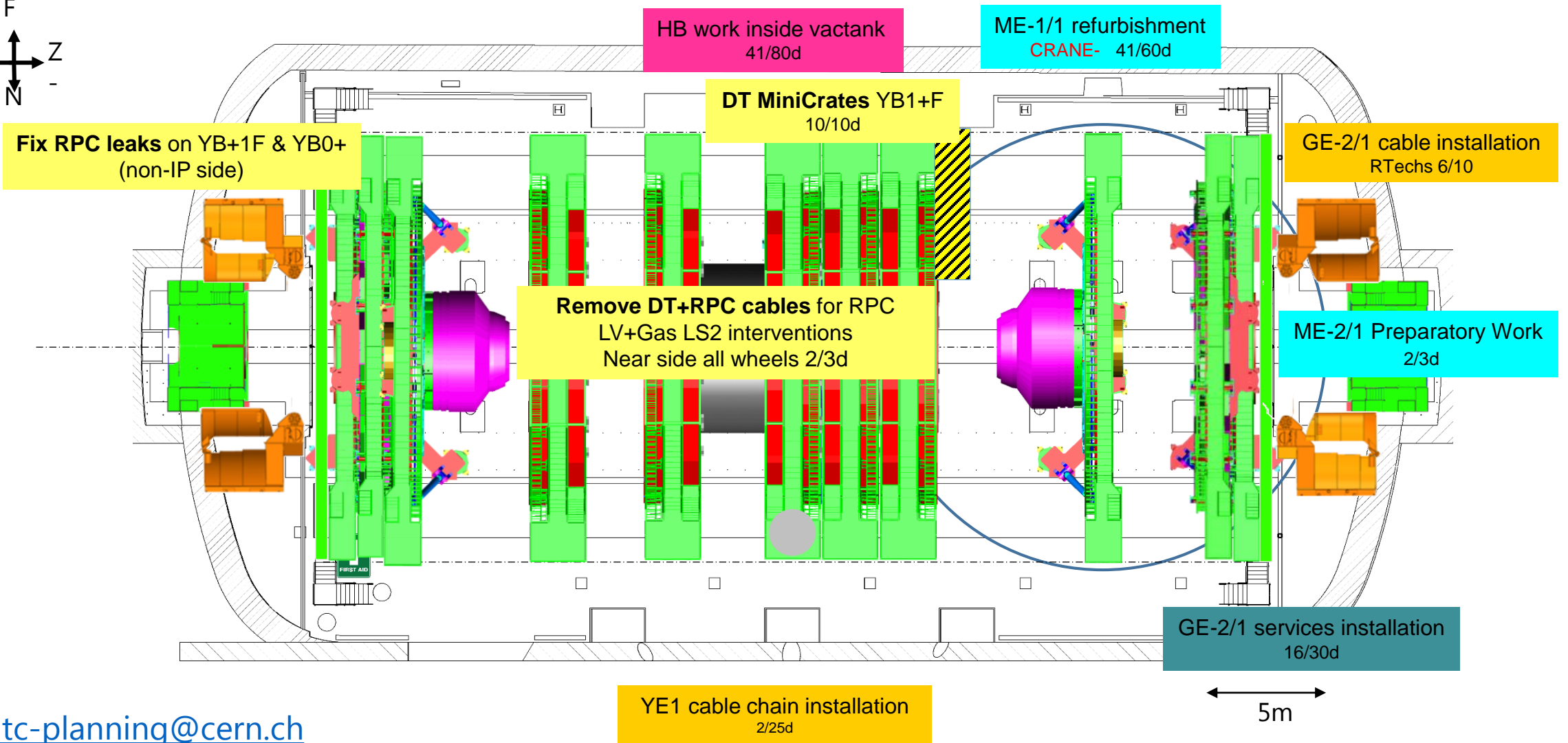
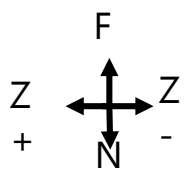



Crane

Cryo.	EL power	Water cool.	Database				
IT	Magnet	C6F14	Gas				
SL. 0	GEM	ECAL	ZEC	DT+ RB	Survey	TE-VSC	SMB
CP. 0	TOTEM	CMX	CSC RE	TK PIX	HCAL	EN Dept	RP

PX56 Plug OPEN

Thursday

TX54 Plug OPEN

25. April 2019

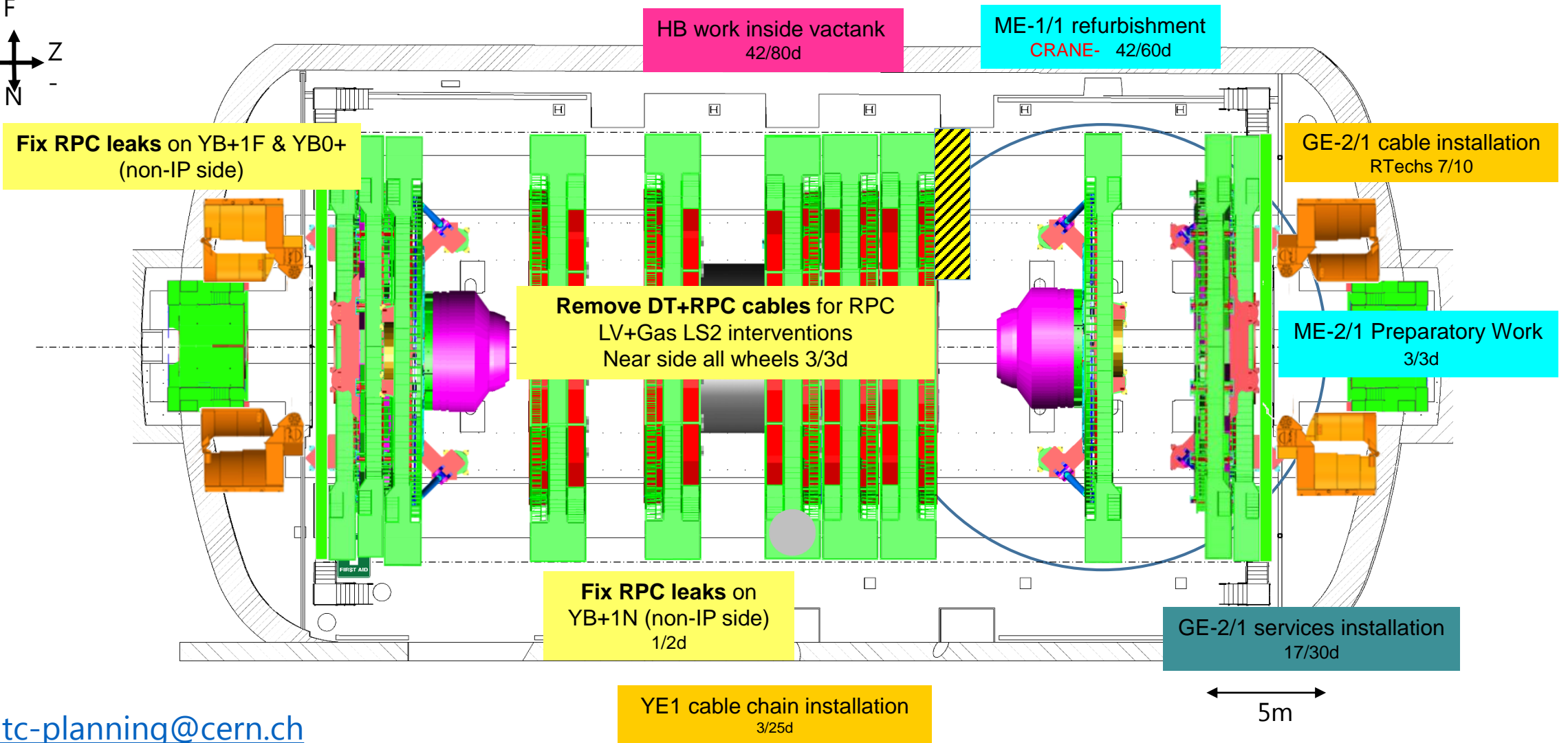
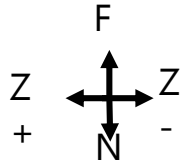



Crane

Cryo.	EL power	Water cool.	Database				
IT	Magnet	C6F14	Gas				
SL. 0	GEM	ECAL	ZEC	DT+ RB	Survey	TE-VSC	SMB
CP. 0	TOTEM	CMX	CSC RE	TK PIX	HCAL	EN Dept	RP

PX56 Plug OPEN

Friday

TX54 Plug OPEN

26. April 2019

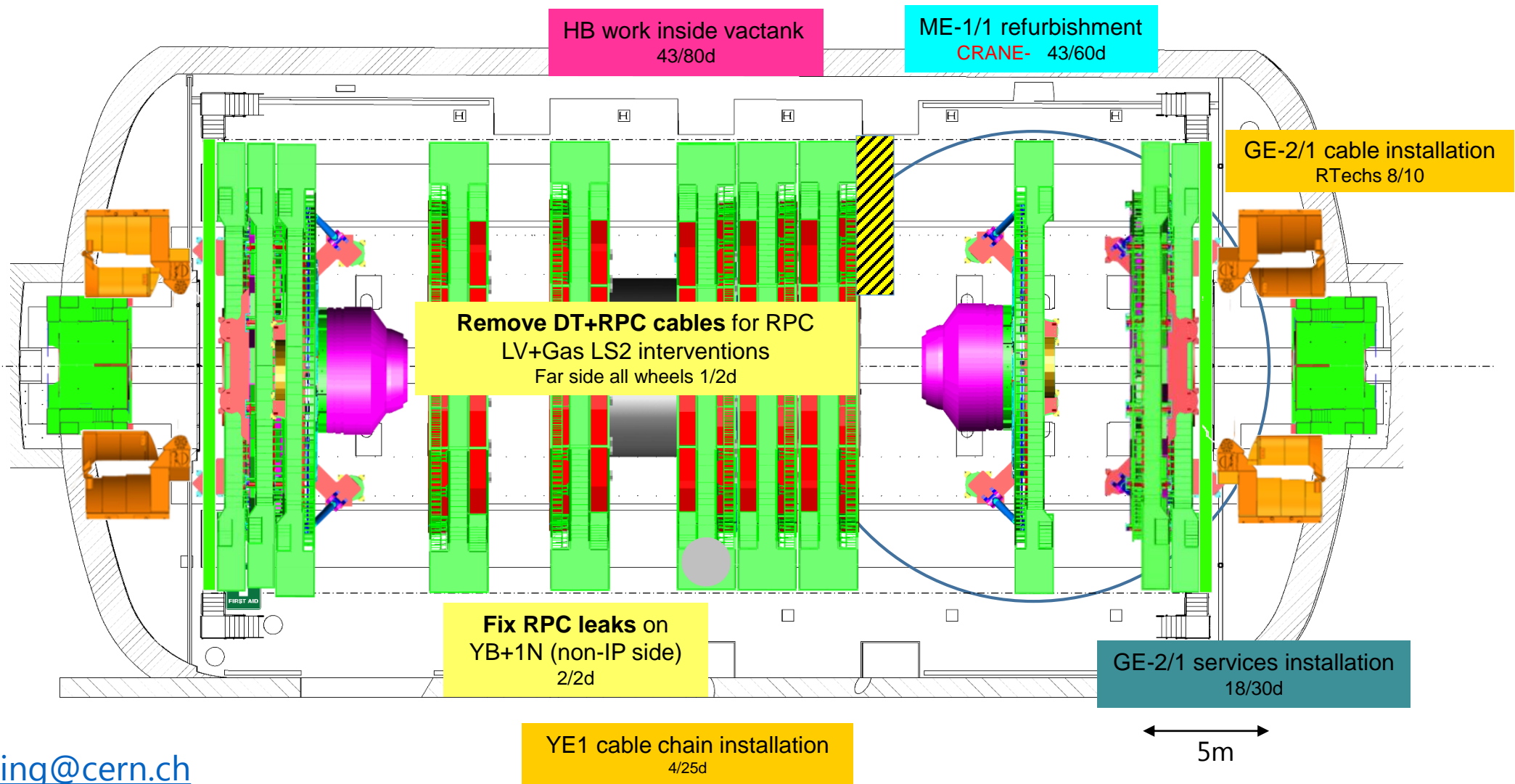
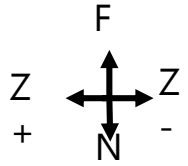



Crane

Cryo.	EL power	Water cool.	Database				
IT	Magnet	C6F14	Gas				
SL. 0	GEM	ECAL	ZEC	DT+ RB	Survey	TE-VSC	SMB
CP. 0	TOTEM	CMX	CSC RE	TK PIX	HCAL	EN Dept	RP

PX56 Plug OPEN
TX54 Plug OPEN

Saturday
27. April 2019

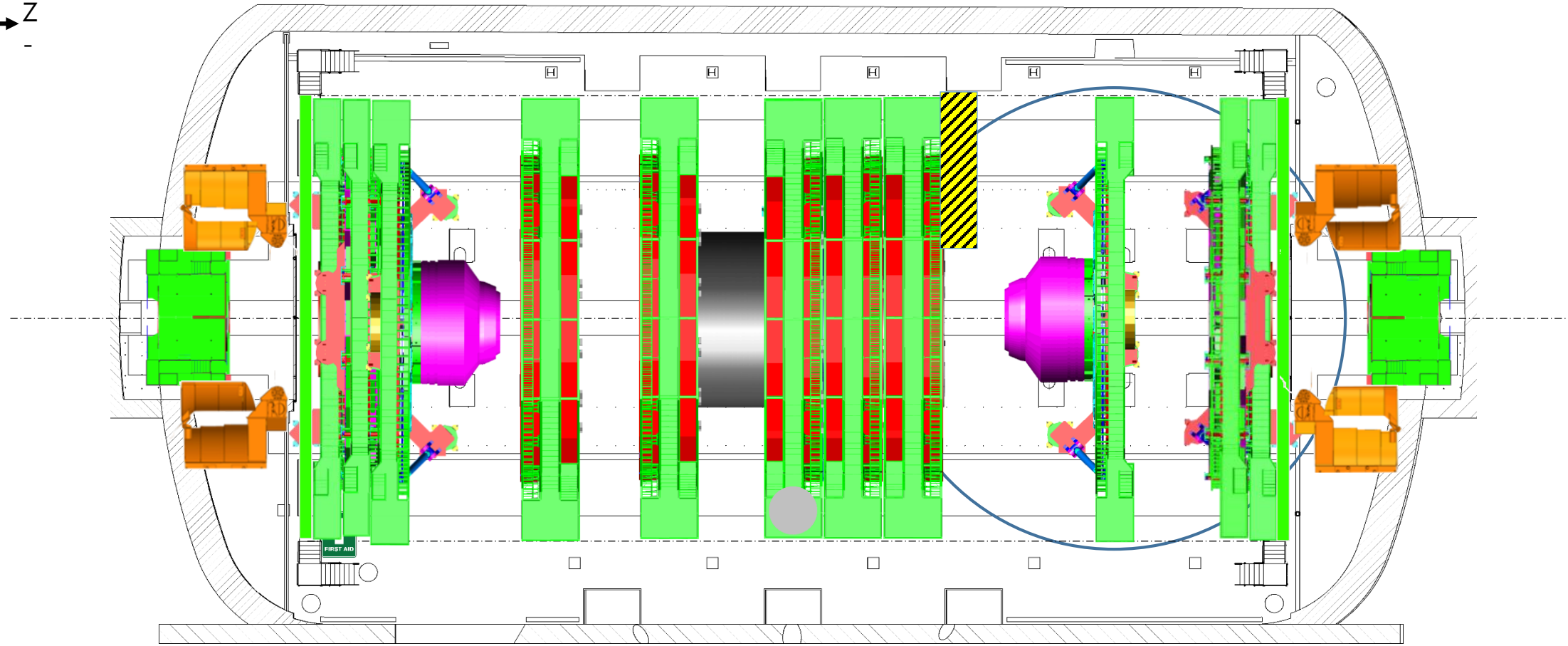
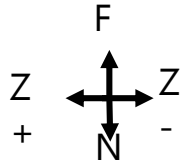

5m



Crane

Cryo.	EL power	Water cool.	Database				
IT	Magnet	C6F14	Gas				
SL. 0	GEM	ECAL	ZEC	DT+ RB	Survey	TE-VSC	SMB
CP. 0	TOTEM	CMX	CSC RE	TK PIX	HCAL	EN Dept	RP

PX56 Plug OPEN

Sunday

TX54 Plug OPEN

28. April 2019

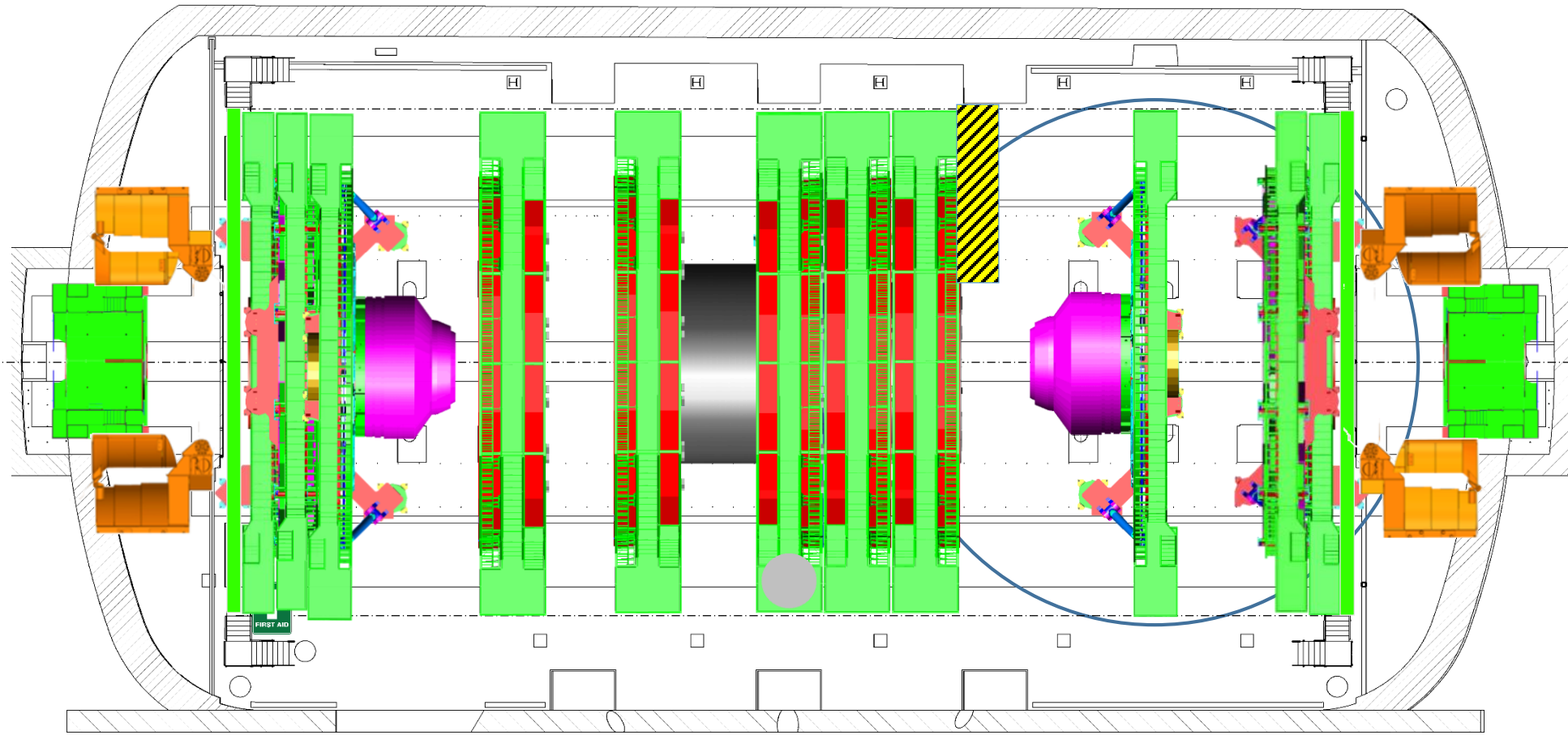
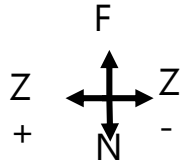

5m



Crane

Cryo.	EL power	Water cool.	Database				
IT	Magnet	C6F14	Gas				
SL. 0	GEM	ECAL	ZEC	DT+ RB	Survey	TE-VSC	SMB
CP. 0	TOTEM	CMX	CSC RE	TK PIX	HCAL	EN Dept	RP

PX56 Plug
OPEN

TX54 Plug
OPEN

Monday

29. April 2019

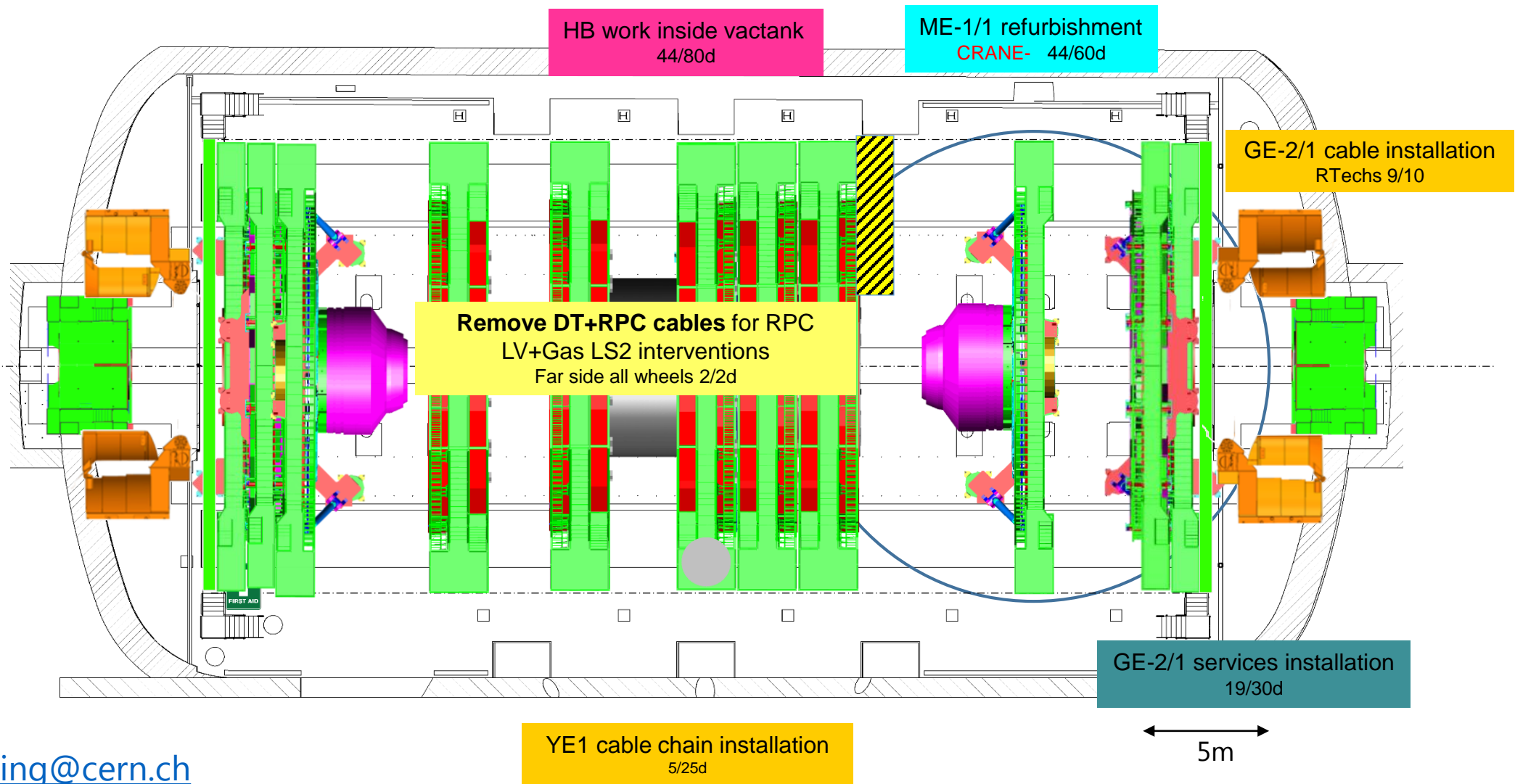
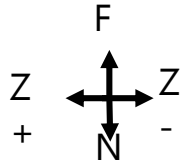



To be continued...