Effects of Humidity on Resistive Plate Chambers

Changguo Lu & Kirk McDonald
Princeton University
October 2, 2007



Humidity, Good or Bad for RPCs?

In general, water vapor *is not always bad for gas avalanche chambers*: adding it to drift chambers can prevent (or mitigate) the Malter effect (discharging across a thin dielectric layer of polymerized gas-breakdown products on the cathode). In the BaBar drift chamber, 4000 ppm water vapor is an essential ingredient of the gas mix; the water vapor makes the polymerized layer slightly conductive and thereby avoids the self-sustaining Malter discharge mode that would otherwise ruin the entire chamber.

There are two “breeds” of RPCs: Glass and Bakelite. Their response to water vapor is very different:

Water vapor is very bad for glass RPCs, but is essential for Bakelite RPCs.



Experience from Belle Glass RPCs

Glass Resistive Plate Chambers in the BELLE Experiment



Daniel Marlow
Princeton University



Seminar at Rice University

July 9, 1999



Belle's Experience

A Major Problem Develops

The first signs of trouble showed up shortly after installation and looked something like the plot to the right. The current from a chamber would “suddenly” show a dramatic increase.

Given that there is a “pedestal” current resulting from the spacers, the true dark-current increase was in fact substantial.

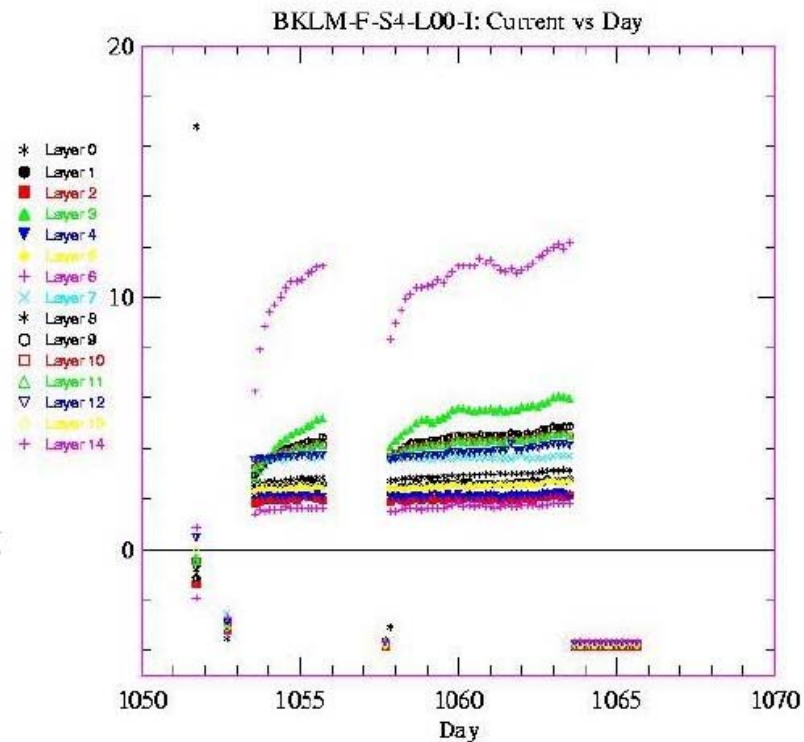

Culprit: Water Vapor

- After several weeks of study we determined that the problem was due to high levels of water vapor in the gas.
- Although we were aware of this problem (even more severe problems occurred in the early days of our R&D when some of our collaborators used urethane gas tubing, which is highly permeable), we had incorrectly assumed that water would not permeate our polyethylene (Polyflow) tubing.
- In fact we were susceptible to water contamination for the following reasons:
 - Low flow rates
 - Long (5~12 m) runs of plastic tubing.
 - Hot and humid weather during the Japanese rainy season.
- Using published data for polyethylene, we were able to account for the ~2000 ppm concentrations of water vapor that we observed.



Belle: Copper Tubing is the Solution for Glass RPCs

We replaced the long runs of polyethylene with copper (~5 km in all!) and flowed gas at the highest possible rate (~one volume change per shift).

Slowly, but surely, the RPCs began to dry out.

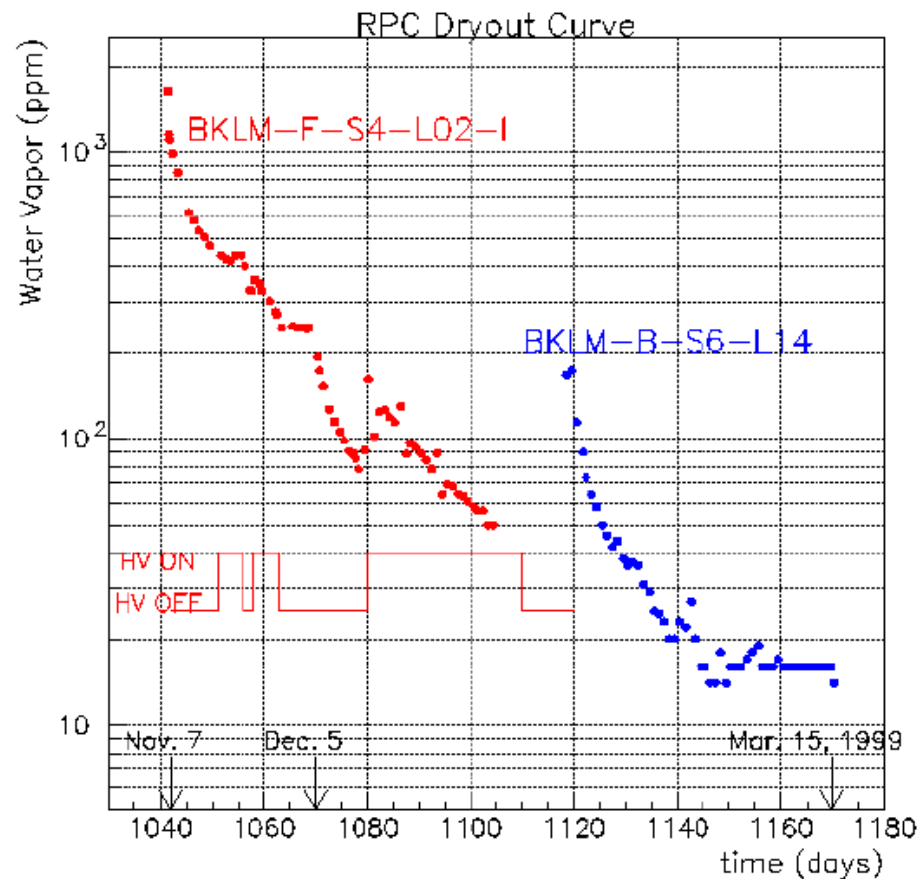

Belle: With a Dry Gas Mix Glass RPCs Perform Well

The dark current drops, and the efficiency increases as the chamber dries out.

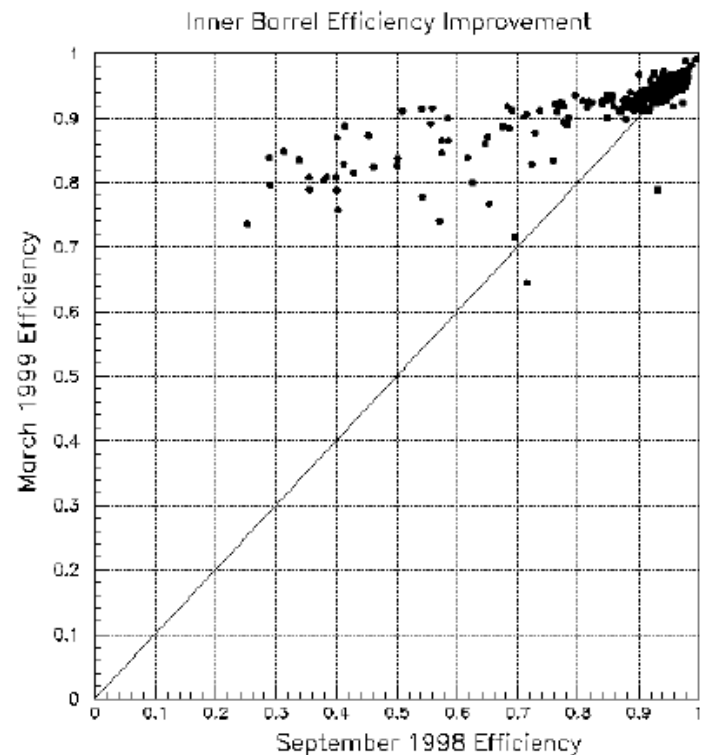
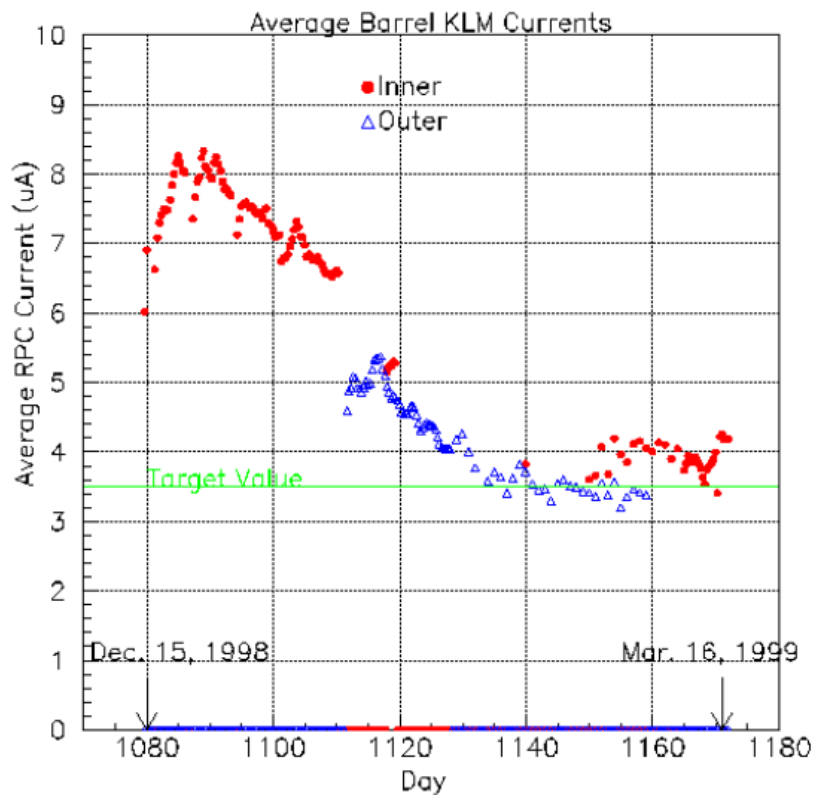

Bakelite RPCs

Water vapor plays very a different role in the Bakelite RPC. BaBar's new version of the endcap RPCs has suffered efficiency loss due to **drying out of the Bakelite** if Teflon (or copper) tubing is used: the gas inlet regions of the RPCs showed lower efficiency.

They tested the relative humidity at the gas inlet and outlet; the former was almost 0%, but the latter was $\sim 20\text{--}30\%$. That is a clear indication that the dry gas mixture removed water vapor out from the RPC, in particular, from the Bakelite sheets. The consequence is higher resistivity of the drier Bakelite, and therefore reduced rate capability and efficiency.

Without beam, the dry regions still showed good efficiency, so the water vapor level is more critical for accelerator applications of Bakelite RPCs than at Daya Bay.

After adding water vapor into the Barar gas mix (30% R.H.) the bad regions disappeared. See next slide for comparison.

[Performance and aging studies of BaBar RPC, Nucl. Phys. B (Proc. Suppl.) 158(2006)139].



BaBar: Before and After Adding Water Vapor to Bakelite RPCs

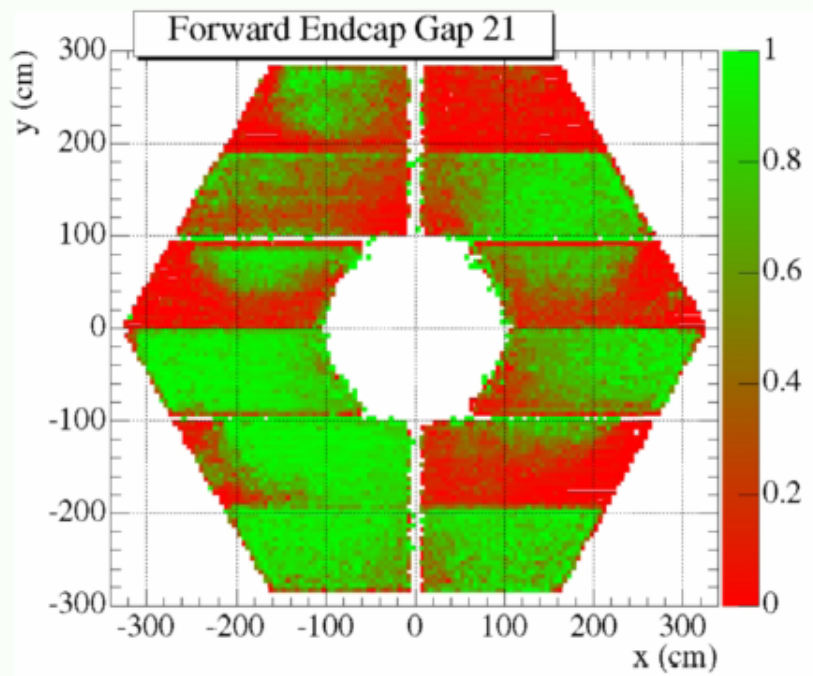

Figure 4. The two dimensional RPC efficiency of layer 16 measured with μ -pairs in April 2005 after 30 months of dry gas flow.

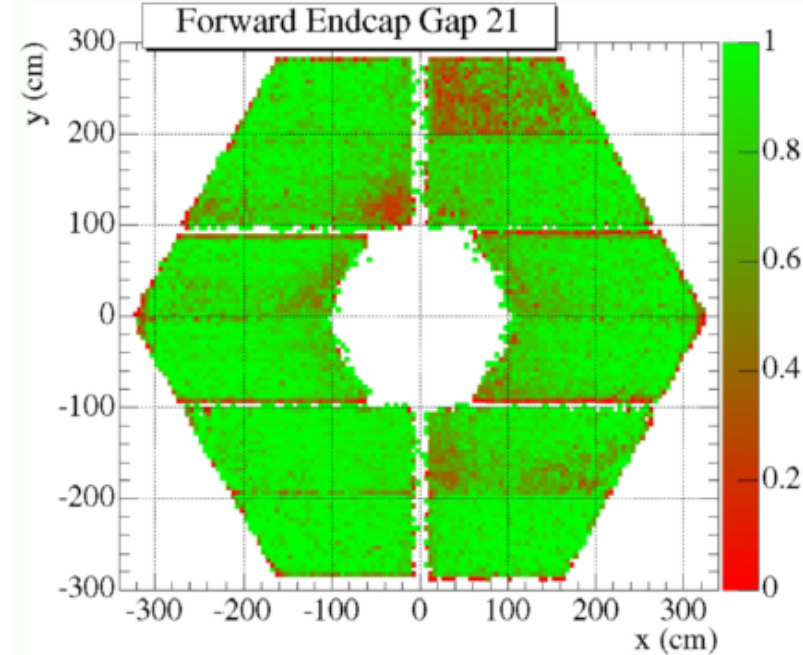

Figure 5. The two dimensional RPC efficiency of layer 16 measured with μ -pairs in the Sep. 05 after 5 months of gas flow humidified to about 30% RH.



Conducting Mechanism of Glass and Bakelite

Glass and Bakelite are insulating materials with very high resistivity. Instead of the electrons as the charge carriers, in these materials the ions are the charge carriers. The current is called *ionic current*.

In a metal, electrons that flow out are always replaced by ones flowing in, and the resistivity is independent of time (at constant temperature).

In an insulator, the ions that are carried away by the ionic current are not necessarily replenished, and the resistivity can increase dramatically.

The relatively low resistivity of Bakelite (compared to glass) is only maintained by a suitable level of water in the Bakelite, which creates a reservoir of ions.



Va'vra's Model of Bakelite Ionic Conduction

(J.Va'vra, http://www.slac.stanford.edu/~jjv/activity/babar_rpc_my_summary.pdf

& "Physics and Chemistry of Aging – Early Developments", DESY Aging Workshop, 2000).

a) BaBar

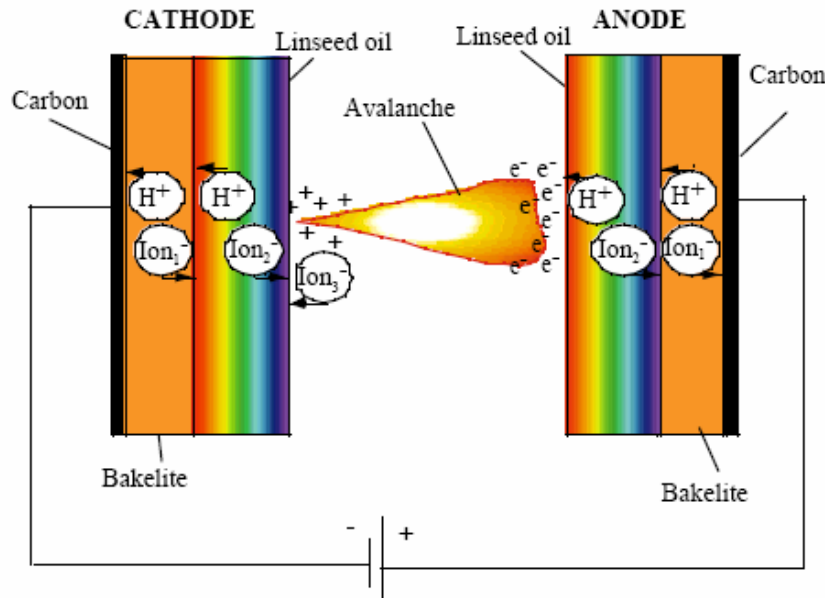

Bakelite:

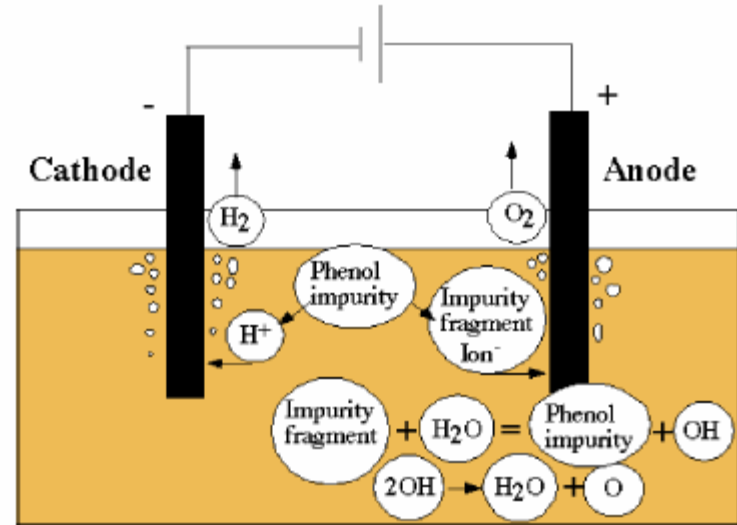

- In Bakelite, water is needed for ionic conductivity near the anode.

- If you remove all water, the current will stop. Many tests are basically consistent with this point.

- The water can be "removed" either by high-current operation or by drying the outer Bakelite layer in a relatively dry gas.



... Glass Ionic Conduction Model

b) Belle

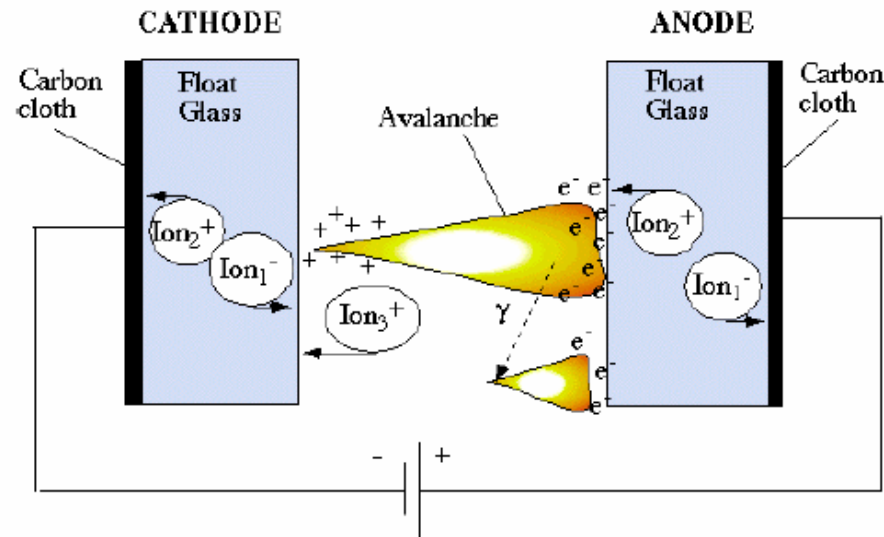

The conductivity in standard glasses is attributed to the movement of the **alkaline ions**, \Rightarrow ionic conducting glasses. Typical resistivity of these materials is $10^{12} - 10^{16} \Omega\text{-cm}$. However, during long-term operation, the alkali ions migrate towards the cathode under the influence of the electric field and leave a depleted layer close to anode. This leads to a large and permanent increase of the surface resistance.



Humidity Effect on Surface Resistivity, σ

(C. Lu, Feb. 24, 2002)

#	Treatment	Wt (g)	R.H. (%)
1	In a sealed box with water and saturated water vapor for 21 hours	31.697	100
2	Exposed to saturated water vapor for 3 hours	31.627	66.2**
3	Normal room humidity	31.596	51.3**
4	In a vacuum bell jar for few hours	31.563	35.5**
5	In a vacuum bell jar for 14 hours	31.489	~ 0.0

Bakelite can absorb a significant amount of water (more than 0.6% of its own weight).

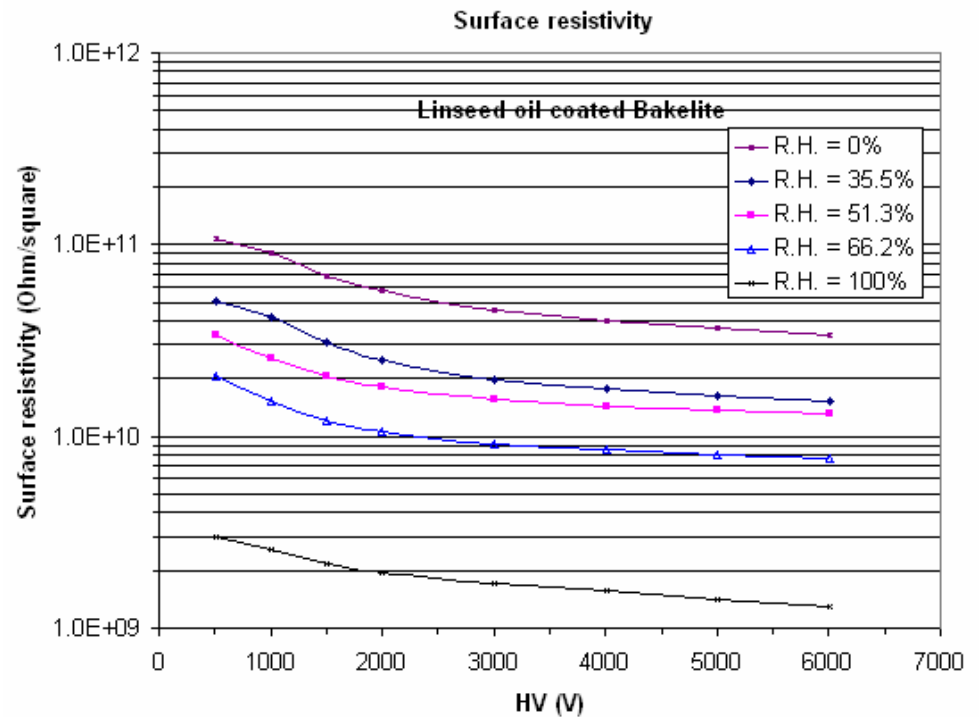

**using linear extrapolation from 0% and 100% data derived this number

Humidity Effect on the Volume Resistivity, ρ

#	Treatment	Weight (g)	Relative humidity (%)
1	In a sealed box with water and saturated water vapor for 6 hours	22.202	~100
2	Normal room humidity	22.164	67**
3	In a vacuum bell jar for 4 hours	22.130	37**
4	In a vacuum bell jar for 14 hours	22.080	~0

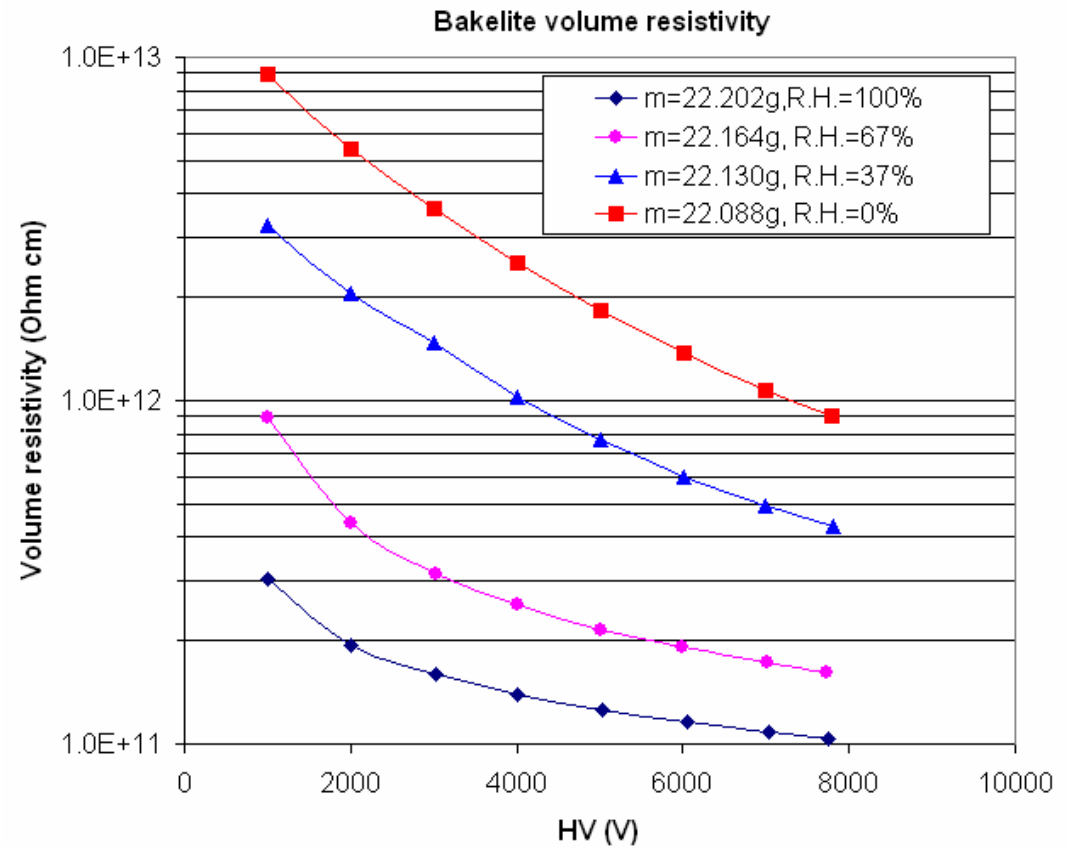

**using linear extrapolation from 0% and 100% data derived this number



Summary of Humidity Effect on the Resistivity

Relative surface resistivity (value @ 100% R.H. as 1)

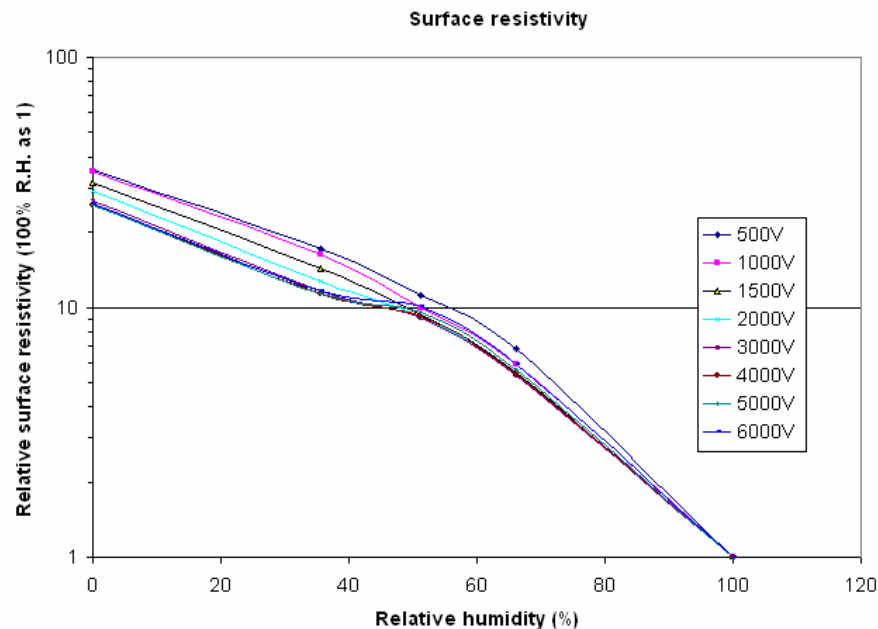

Relative volume resistivity (value @ 100% R.H. as 1)

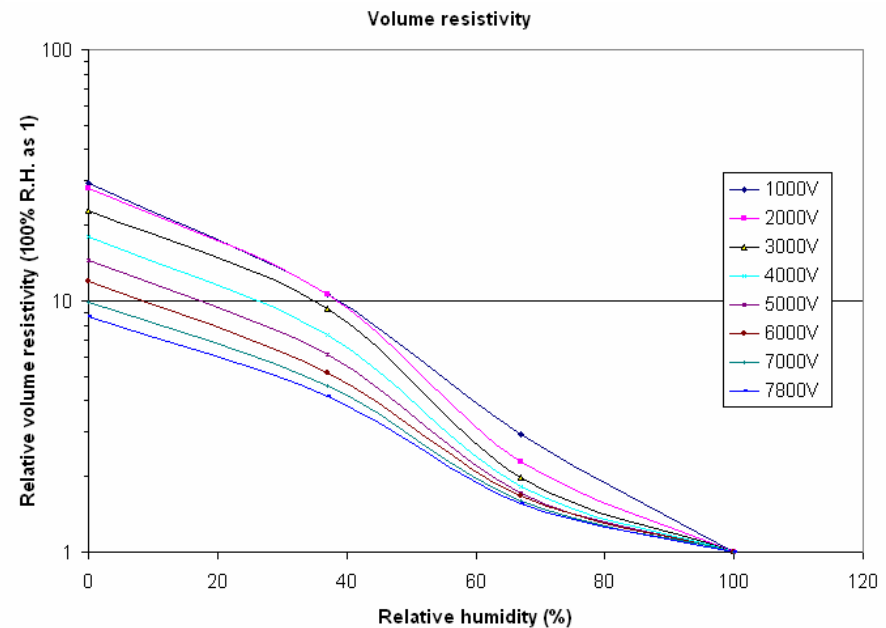

Both surface and volume resistivity show the same trend: resistivity decreases when relative humidity (R.H.) increases.



Permeability of Polyolefin Tubing

Dan Marlow and Kazuo Abe did a test in Oct. 1999 to check the permeability of the Polyolefin (Polyflo) tubing, which was used for Belle RPC gas distribution.

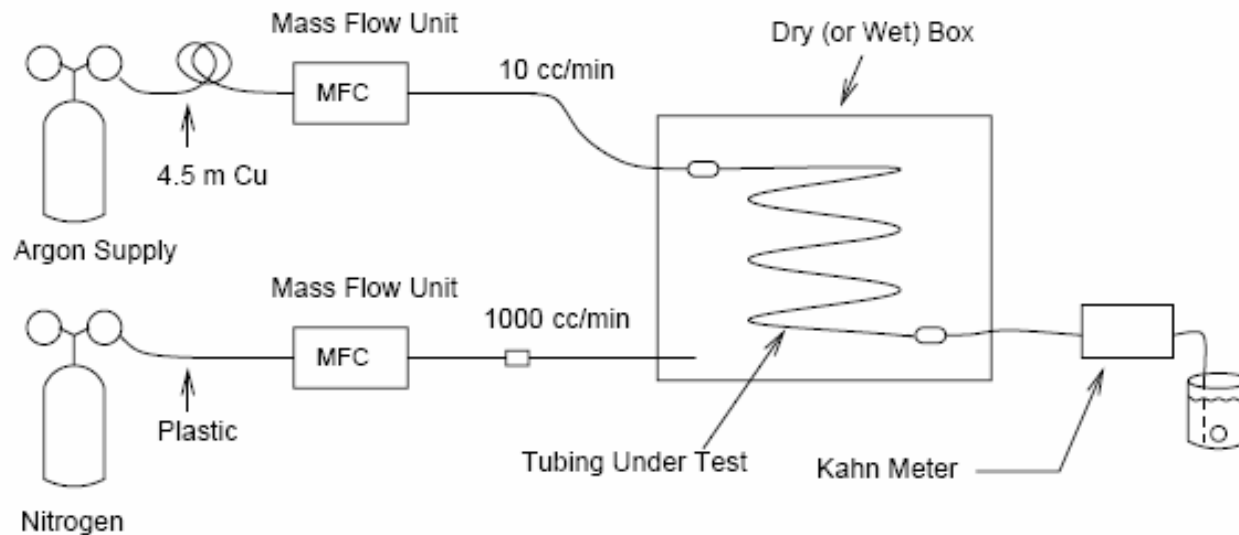

Typically, they were able to achieve a relative humidity of 15% in the dry/wet box. Once the system had fully dried, the nitrogen flow was stopped and the bottom of the box was filled with a small puddle of water. This caused the humidity in the box to quickly (in about 1 hour) climb to 90%.



... Permeability of Polyolefin Tubing

Permeability of polyethylene is $P = 4.6 \times 10^{-10} \text{ g/cm} \cdot \text{atm} \cdot \text{s}$.

The rate of water vapor penetration is given by

$$dM/dt = P \cdot \Delta p \cdot A/s,$$

where s is the thickness of the barrier in cm, A is its area in cm^2 , and Δp is the partial pressure difference in atmospheres.

For 1/4" Polyolefin tubing: ID 4.7 mm, OD 6.5 mm, wall thickness 0.89 mm, the level Q of water vapor in parts per million will be approximately

$$Q \text{ (ppm)} = 2080 \cdot l \cdot R / F,$$

where l is the length of the tube in meters, F is the flow in cc/min, and R is the relative humidity (@50% R.H. $R = 0.50$).

Thus, for the 4.5 m length of polyolefin at 90% humidity, we expect a water concentration of 842 ppm, in good agreement with the observed value of 940 ppm.



... Permeability of Polyolefin Tubing

J. Va'vra did a similar test, his results are somewhat lower than Belle's number (same reference as on slide #11)

**How much water permeates through a wall
of the 80ft-long 1/4 inch dia. Polyflow tubing ?**

- 80ft-long black Polyflow tubing (1/4 inch dia.)
- Keep the tubing at constant temperature of $\sim 23^{\circ}\text{C}$.
- Gas flow $\sim 65\text{cc/min}$;

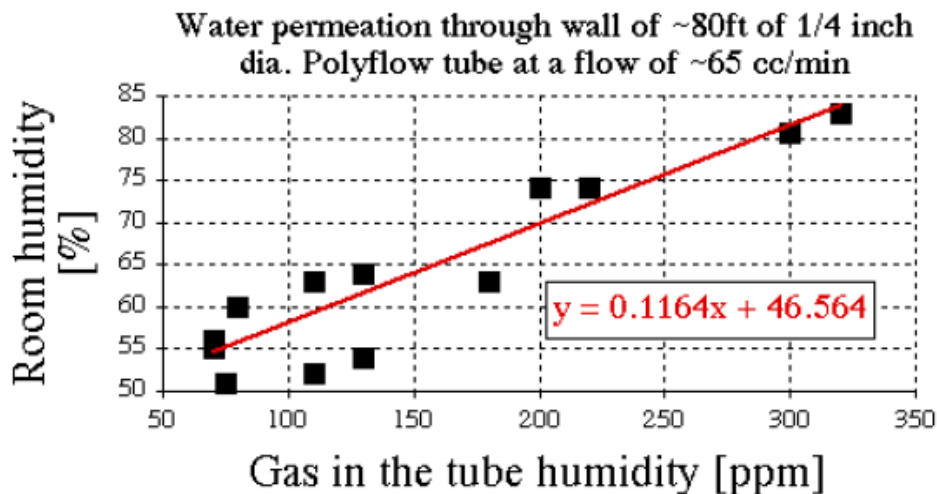

He measured for 80ft $\frac{1}{4}$ " Polyolefin tubing at 85% R.H. under 65 sccm flow rate, the water content at the end would be $\sim 325\text{ppm}$. With the formula on the previous page it would be $\sim 700\text{ppm}$. For 10m long tubing the number should be **125ppm** and **270ppm**, respectively.



Teflon Tubing Permeates Much Less Water Vapor

- BaBar switched to Teflon tubing @ 65 cc/min, 61-74% rel. humidity and 93 ft long tubing:
 - After ~8 hours get only ~200 ppm at 74% humidity.
 - After ~16 hours get only ~120 ppm at 71% humidity.
 - After ~5 days get only ~30 ppm at 61% humidity !!!!!
- The gas flowing into the BaBar RPCs is rather dry !!!

Of course, copper tubing permeates no water vapor.



Influence of Humidity on the Dark Current

To study the behavior of RPC system in the possible high humidity environment at the Daya Bay underground experimental hall, we use an environmental chamber - Thermotron SM4S, which can control the relative humidity and temperature of the chamber.



Environmental chamber

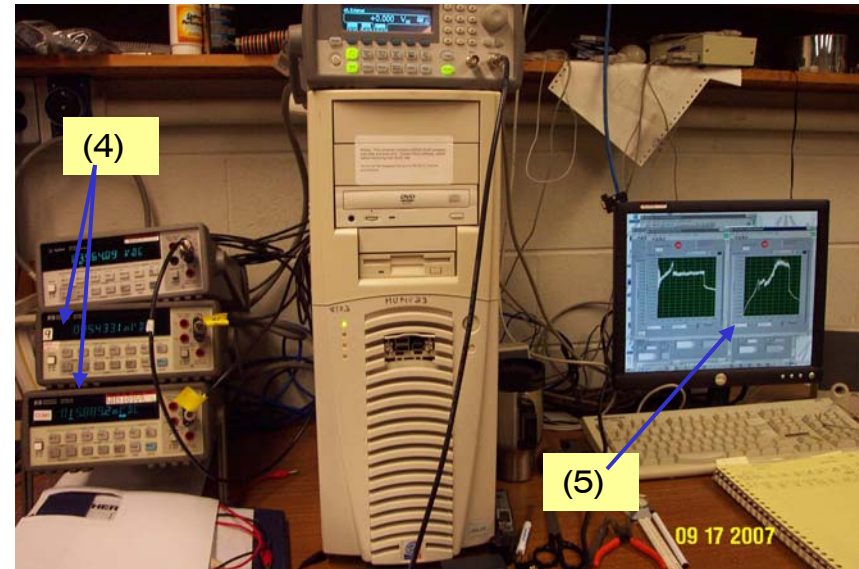
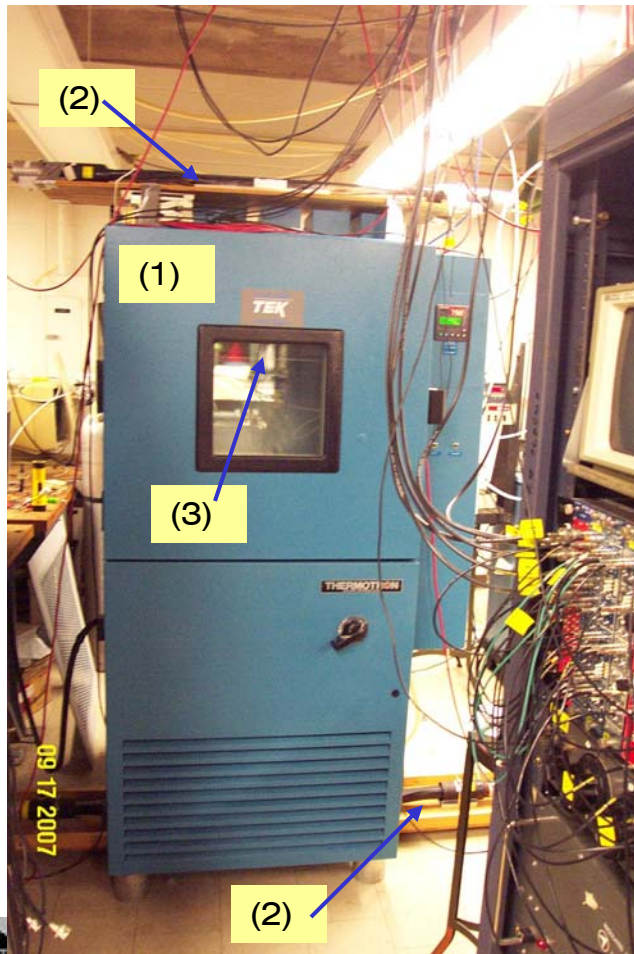

(1) Thermotron SM4S humidity/temperature; (2) Trigger telescope; (3) Test RPCs inside of the chamber; (4) HP multimeter to monitor HV current; (5) LabView to record/display the HV currents and humidity.



Dark Current vs. Relative Humidity

Two IHEP RPC prototypes (50 x 50 cm²) are put into the humidity chamber. Control the R.H. at 30, 60 and 90% while keeping the temperature at 25°C constant, H.V. = 5800V.

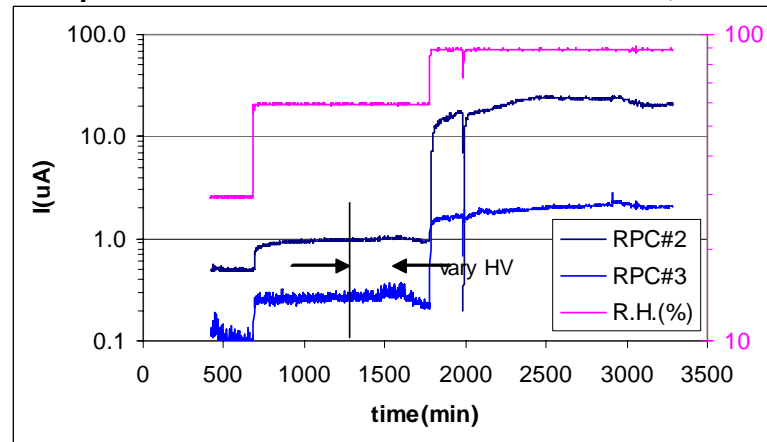

We can see a huge jump in the dark current when we increase the R.H. from 60% to 90%. The two chambers are not the same, RPC #2 reacts to the R.H. much more dramatically.

The test chamber is only 50 x 50 cm², if we assume the dark current is due to the leakage along the edges (see following slides), for a 1m x 2m RPC the edge length will be 3 times of the test chamber, that means @90% R.H. and 5800V the dark current could be $30 \times 3 = 90\mu\text{A}$!



More Detailed Study of the Dark Current

What causes the dark current to jump at high humidity?

Replace the RPC gas with pure Ar, \Rightarrow chamber discharges at very low H.V. The strong discharge inside the chamber actually shorts the gap between two Bakelite electrodes, and we can measure Bakelite resistivity *in situ*. See the two slopes on the I vs. HV plot:

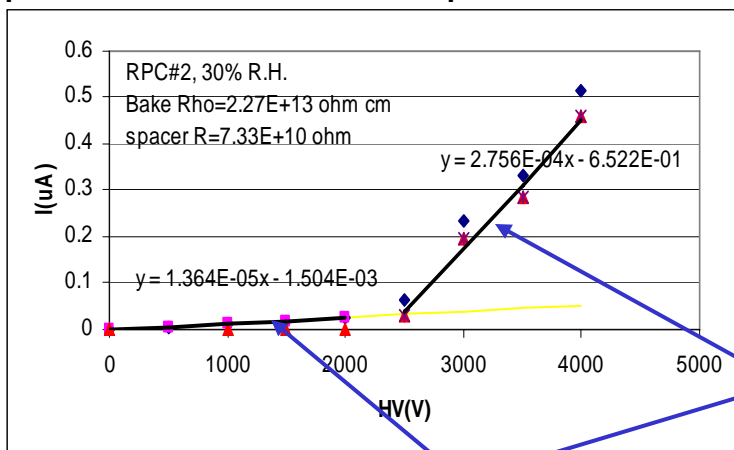

HV < 2000 V,

No gas discharge; I vs. V line indicates the resistance through the spacers and edge sealing strips.

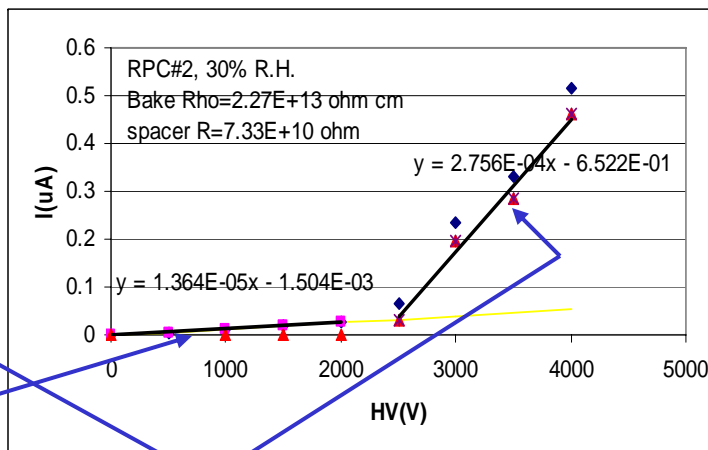

HV > 2000V,

Ar discharge is taking place, I vs. V line represents the Bakelite resistivity.

30% R.H.



More Ar Test Results

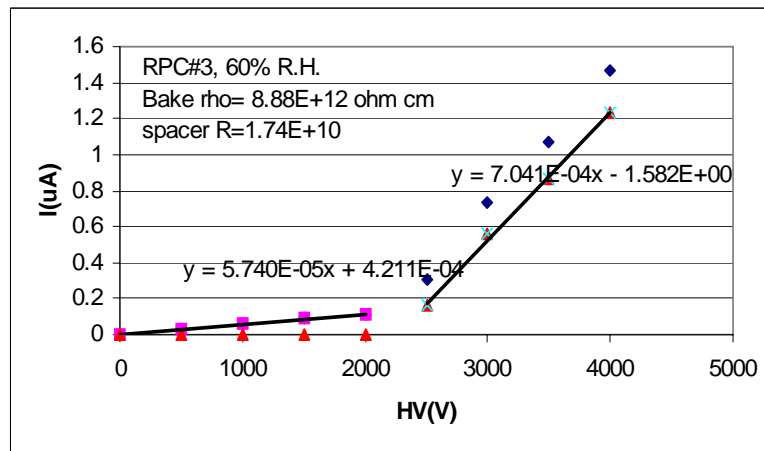
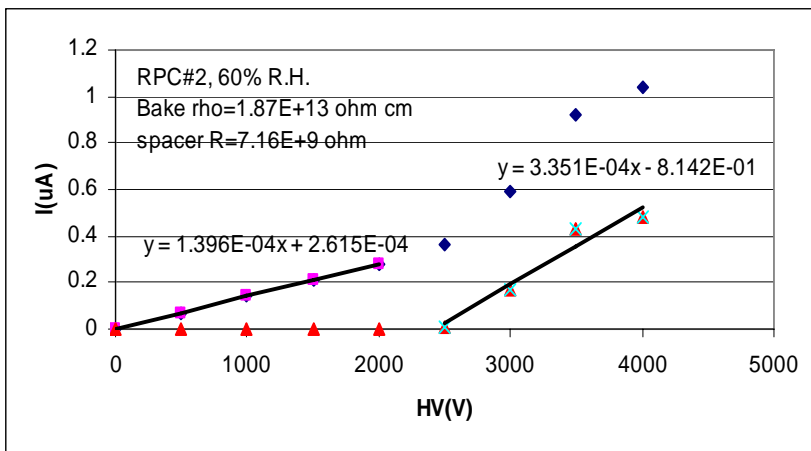

60% R.H.

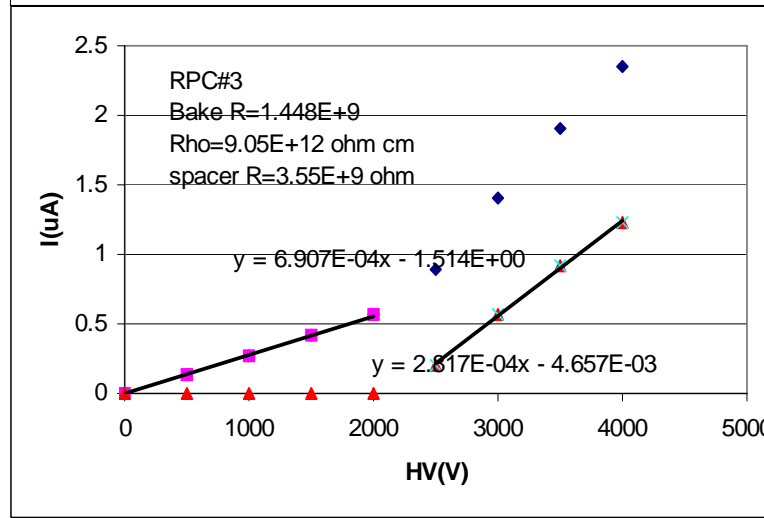
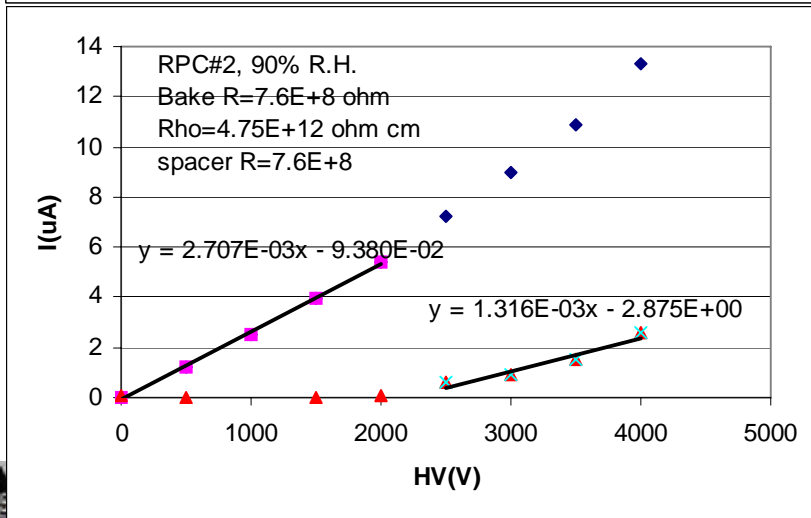

90% R.H.



Summary of Resistivity vs. Relative Humidity

<2000V, Spacers & edges

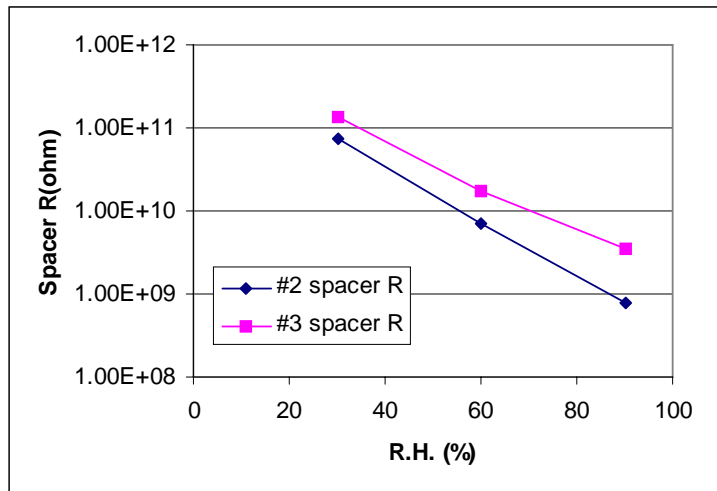

> 2000V, Bakelite

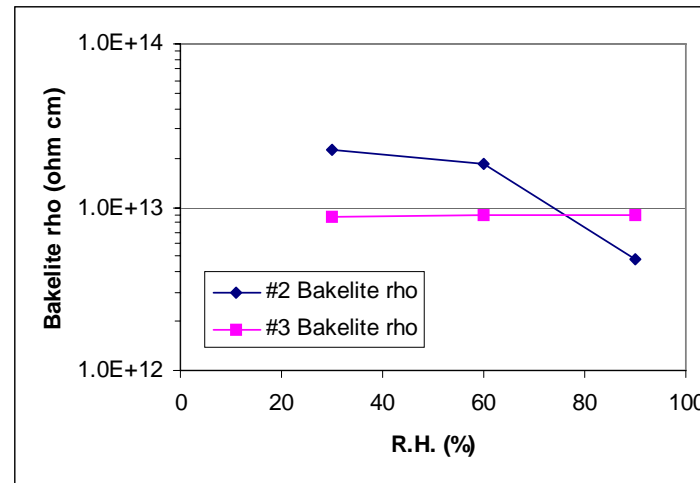

The spacer resistance is very sensitive to the humidity, when R.H. changes from 30% to 90% the value changes almost two orders of magnitude.

The Bakelite resistivity is less sensitive to the short-term changes in the humidity, RPC #3 keeps constant at 3 different R.H. RPC #2 changes the resistivity by fact of ~5.



Illustration of the Leakage-Current Path along the Edges

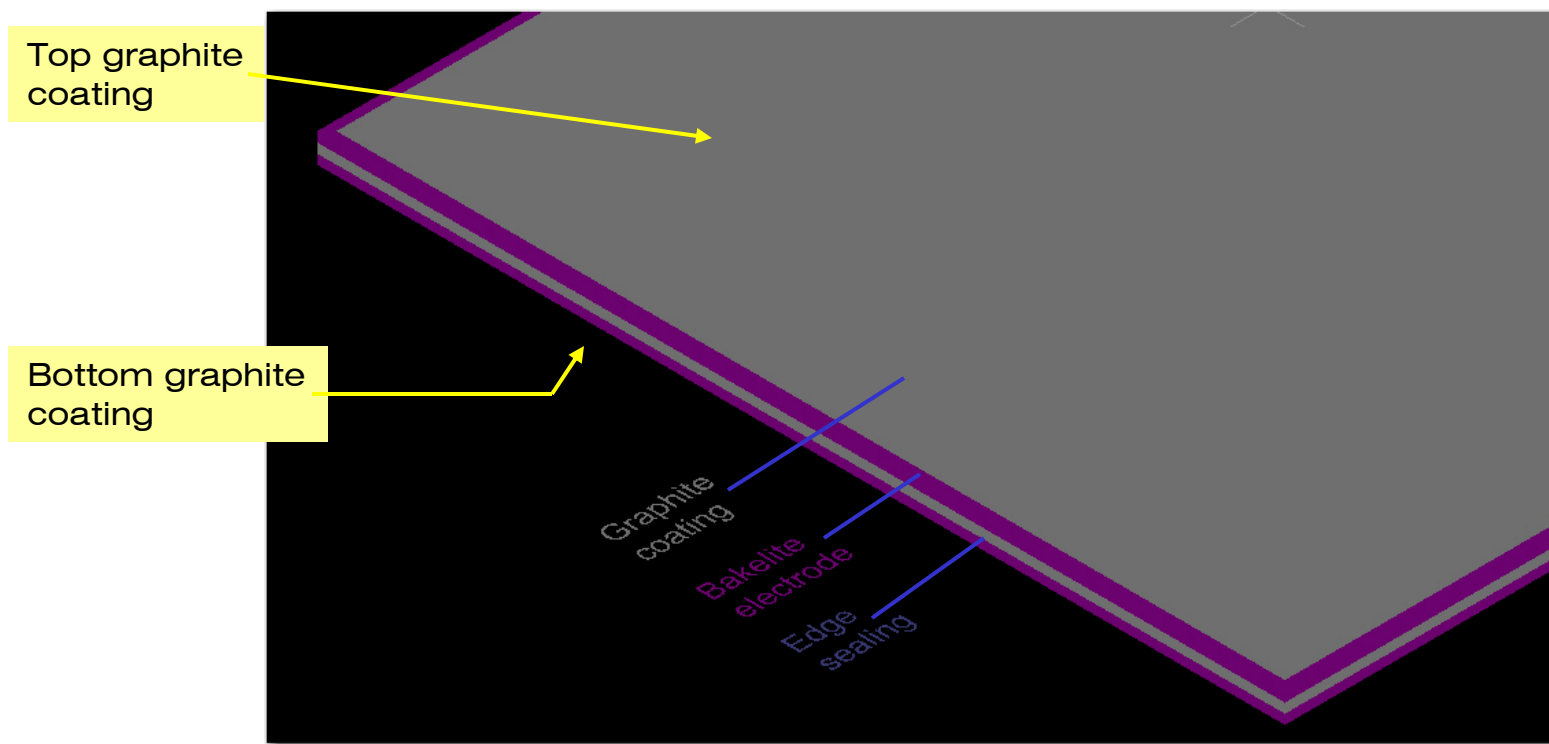

The bottom, as well as the top, outer surfaces, are coated with graphite. +/- HV is applied to the graphite coatings. The entire uncoated surface along the edge regions can be the leakage-current path.



Summary of Resistivity vs. Relative Humidity, Cont'd

This test results show that increased dark current is due to the leakage along the uncoated edge surfaces.

If we can block this path, we should be able to reduce the dark current in high humidity environment. We are testing a special Dow Corning product – Sylgard HVIC+, which is a coating material used to reduce surface currents, arcing and flashover on high-voltage standoffs in the electric power industry.

The Bakelite bulk resistivity isn't very sensitive to the exterior humidity. According to our previous discussion, Bakelite retains plenty of water inside (0.6% by weight). As long as this water reserve can provide enough ions for the desired current, the ambient humidity won't make difference to the resistivity.

However, under a very dry environment, flowing a dry gas mix and operating the RPC in high-rate conditions for long period would eventually use up the water molecules in the Bakelite and increase the resistivity.



Preliminary Test Results for Sylgard HVIC+ Coating

Since RPC#2 shows a huge jump when the R.H. increased from 60% to 90%, we chose it to test Dow Corning Sylgard HVIC+ coating. After very simple cleaning of the edges with ethanol, we apply this coating on four edges of RPC#2. After about one hour of drying put this chamber back into the humidity chamber. The test results are as following: (will add a plot later).

We can clearly see that the jump between 30% and 90% of R.H. is much smaller than w/o HVIC+ coating. Now RPC#2 and #3 are behaving similar. We don't know if this improvement is only due to the ethanol cleaning or HVIC+ coating. More testing is needed. If it is confirmed that the Sylgard coating is helpful, this coating could added to the RPC mass production.

The Sylgard HVIC+ is not too expensive, \$350/10lb (~4 liter), which can coat ~150 RPCs. Total cost for 1500 RPCs is ~\$3,500.



Could the Daya Bay RPCs Become Dried Out?

Let's consider two previously discussed, more or less understood effects: ionic current & dry gas flow.

Ionic current:

Assume 500 pC/streamer = 3.1×10^9 e's/streamer;

Rate = 0.2Hz/cm²;

Water content in Bakelite electrode = 0.6% by weight
= 1.5 mg/cm² = 10^{20} H₂O/cm²;

If each water molecule can neutralize one electron from a streamer, 10^{20} water molecule can supply to 3.2×10^{10} streamers/cm²;

⇒ Can last for $3.2 \times 10^{10} / 0.2 / 3600 / 24 / 365 = 5.1 \times 10^3$ years!

Thus with the Daya Bay counting rate, the ionic current shouldn't cause any trouble.



Dry Gas Flow

As BaBar RPC tested [NIM A 552 (2006) 276], the gas relative humidity at the inlet is almost 0%, the outlet after two 2m x 1m RPCs in series is $\sim 20 - 30\%$. We assume the humidity in the gas mixture at the outlet has reached the equilibrium state, within certain flow rate range the R.H. here is not sensitive to the flow rate.

Assume the flow rate is 1 volume/day. If we connect 4 RPCs in series, the total volume is $16,000 \text{ cm}^3$, the flow rate is 11 sccm. At 20°C the saturated water vapor pressure is 17.54 mm Hg, 20% of R.H. means 3.5 mm Hg \Rightarrow 4600 ppm of water vapor in the gas mix $\Rightarrow 3.3 \times 10^{-3}$ Moles of water. As we mentioned before, Bakelite contains 0.6% of water by weight, two 2m x 1m x 0.2cm Bakelite plates contain 60g of water, *e.g.* 3.33 Moles. Enough to supply 2.77 years. That is an average estimation, actually the region around the gas inlet area would be drying out much fast than the rest of the area.

Therefore we have to add water vapor into the gas mixture to prevent the Bakelite from drought.



Conclusions

- Bakelite RPCs need water to maintain their functionality. The chamber gas should include 2000-4000 ppm of water vapor, which can be introduced via a simple water bubbler in the input gas stream.
- In a high-intensity accelerator environment the ionic current flowing through the Bakelite electrode can dry out the Bakelite, but in the Daya Bay experiment this is not a concern.
- A dry gas flow, using Teflon or copper tubing, would dry out the Bakelite and compromise the performance of the Daya Bay RPCs.
- The use of inexpensive polyethylene tubing in the gas system will introduce 200-1000 ppm of water into the chamber gas.
- Since water vapor should be added in either case, we propose to use water bubblers + the more inexpensive polyethylene tubing in the Daya Bay RPC system.
- Continuous monitoring of water vapor levels with, for example, Kahn Cermet II hygrometers should be considered.
- A high-humidity environment can dramatically increase the leakage current. Dow Corning Sylgard HVIC+ is a good coating material to prevent this from happening.



Appendix: Permeation of Water Through Bakelite and Mylar

So far we have ignored one effect: the Bakelite plate itself can absorb water vapor from the ambient. The RPC is covered by Mylar sheet on both side. The present production plan is going to glue the entire Mylar sheet on the top of the graphite coating, so we can assume the Mylar sheet will act like a partial vapor barrier in front of the Bakelite.



Du Pont Data Sheet on Mylar's Permeability

Permeability

Mylar® polyester film is virtually impermeable to the liquid phase of most chemicals and reagents. The permeability of Mylar® to the vapor phase of some typical chemicals is shown in Table 4. The effect of film thickness on the rate of water vapor transmission through Mylar® is shown in Figure 1. Gas permeability rates are shown in Table 4 and Figure 2. Marked reductions in gas permeability (up to a factor of 100) can be obtained through polymeric coatings, metal foil laminations, or vacuum metallization.

Table 4
Permeability of Mylar® to Gases and Vapors

Vapors		g/100 in ² /24 hr/mil*	
Acetone		2.22	
Benzene		0.36	
Carbon Tetrachloride		0.08	
Ethyl Acetate		0.08	
Hexane		0.12	
Gas	Temp., °C (°F)	cc/100 in ² /24 hr/atm/mil	Test Method
Carbon Dioxide	25 (77)	16	ASTM D1434-58
Freon® 12	55 (131)	0.01	
Methane	25 (77)	1	

* Permeabilities of vapors are determined at the vapor pressure of the liquid at the temperature of the test, 40°C (104°F), using 1 mil film.

Figure 1. Water Vapor Transmission Rate of Mylar® at 38°C (100°F) (ASTM E-96, Procedure E)

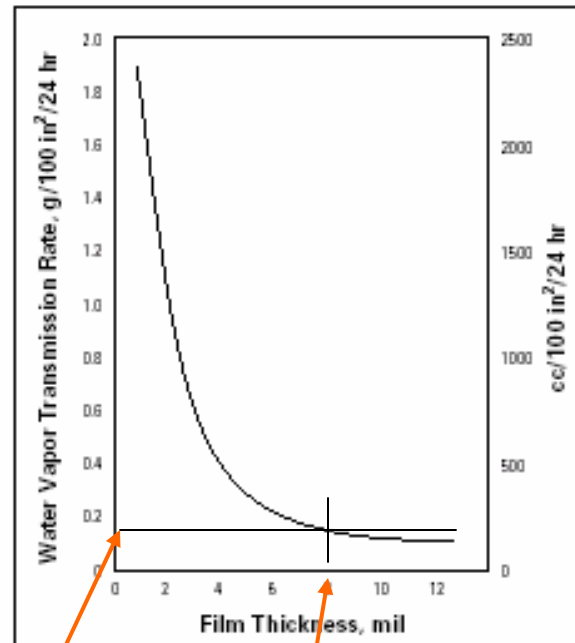

200um thick Mylar

Water trans. rate ~ 0.15g/100in²/day. At 20°C T.R. is about half of this value: 0.07

Figure 2. Gas Permeability of Mylar® vs. Temperature

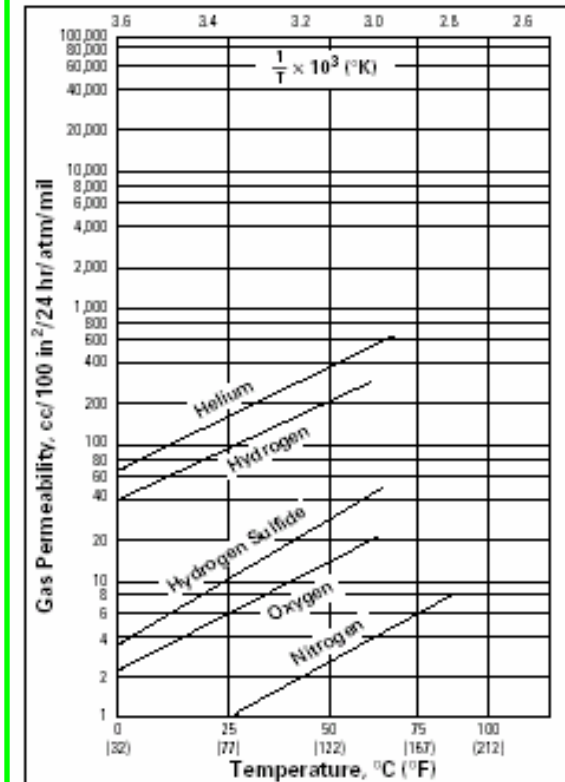

Permeability of the Mylar Sheet

According to Du Pont's data sheet, a Mylar sheet is a barrier to liquid water, but it is not a good barrier for water vapor.

$$R = P \cdot A \cdot \Delta p / t$$

where R is the transmission rate of water vapor, P is Mylar permeability, A is the area of Mylar sheet, t is the thickness of Mylar, Δp is the pressure difference across the Mylar.

We can deduce the permeability P from Du Pont's data sheet: for 8-mil-thick Mylar with 100 in² area, R = 0.15 g/day, $\Delta p = .065$ atm (saturated water vapor pressure at 38°C), and hence,

$$P = R \cdot t / (A \cdot \Delta p) = 0.15 \cdot 0.008 / (10^2 \cdot 2.54 \cdot 0.065)$$

$$P = 7.27 \cdot 10^{-5} \text{ g}/(\text{cm} \cdot \text{atm} \cdot \text{day})$$

For a 2m² RPC, A = 2×2 = 4m², at 20°C and R.H. = 50%, $\Delta p = 0.013$ atm, and

$$R = 1.86 \text{ g/day,}$$

assuming the other side of the Mylar at 0% humidity.

See the next slide for better assumptions.



When the Water Vapor Reaches Equilibrium...

If the flow rate of the RPC chamber is 10sccm (1.44×10^4 cc/day), and the gas carries away all permeated-in water vapor, the water content for the outlet gas mixture should be:

$$(1.86\text{g}/18\text{g}) * 22400 / (1.44 \times 10^4) = 0.16 = 160,000\text{ppm}!!!$$

That number is much higher than the ambient water content 11300ppm (50% R.H. at 20°C). What's wrong?!

Because we assume the humidity at the other side of the Mylar is 0% to calculate water vapor transmission rate. In fact the other side of the Mylar is glued to Bakelite, which is not at 0% humidity, so the water vapor transmission rate would be less than what we calculated here. The water vapor will reach an equilibrium level, at that level the permeated water vapor will equal the carried away water vapor.

When that equilibrium achieved, what is the water content of the outlet gas mixture?



...When the Water Vapor Reaches Equilibrium...

$$R_{in} = P \cdot A \cdot \Delta p / t$$

$$\Delta p = p_a - p_c$$

where p_a is the ambient water vapor partial pressure, p_c is the water vapor partial pressure inside of the chamber, R_{in} is the water vapor transmission rate through the wall.

$$R_{out} = p_c \cdot F \cdot (18/22400)$$

where R_{out} is the water vapor leaving rate (carrying away by flowing gas), F is the gas flow rate, $18/22400$ is the conversion coefficient from volume to weight for water vapor. When water vapor reaches an equilibrium state, $R_{in} = R_{out}$:

$$P \cdot A \cdot (p_a - p_c) / t = p_c \cdot F \cdot (18/22400),$$

$$p_c = P \cdot A \cdot p_a / (F \cdot t \cdot 18/22400 + P \cdot A)$$

If we take the permeability of Mylar $P = 4.97 \cdot 10^{-8}$ g/(cm*atm*min.), $p_c = 0.01$ atm = 10000ppm, ($p_a = 11300$ ppm).

In fact the Mylar sheet is covered by copper strips, that will reduce the permeability by a big fact. If we assume the uncovered area is 10% of total area, then P will be reduced by a fact of 10, $p_c = 6.25 \times 10^{-3}$ atm = 6250ppm.

